

FULL-LINE
C A T A L O G

2

0

2

1



2

2



HEAT  **D**

THE RIGHT LIGHT, RIGHT WHERE YOU NEED IT.

HIGH-OUTPUT
ECONOMY LED
WORK LIGHT
LINEUP

NEW
PRODUCT
NOW AVAILABLE



Explore products | pg. 197



WATCH NOW



NEW PRODUCTS | 2021

LED Projector Beam Headlights | pg.218-219



Truck-Lite High-Output LED Work Lights | pg.196



Signal-Stat High-Output LED Economy Work Lights | pg.197



Heated LED Stop/Turn/Tail | pg. 14, 15, 27, 34-37



45° Series, 3"x 5", LED, Stop/Turn/Tail | pg. 31, 32

This catalog features a new layout

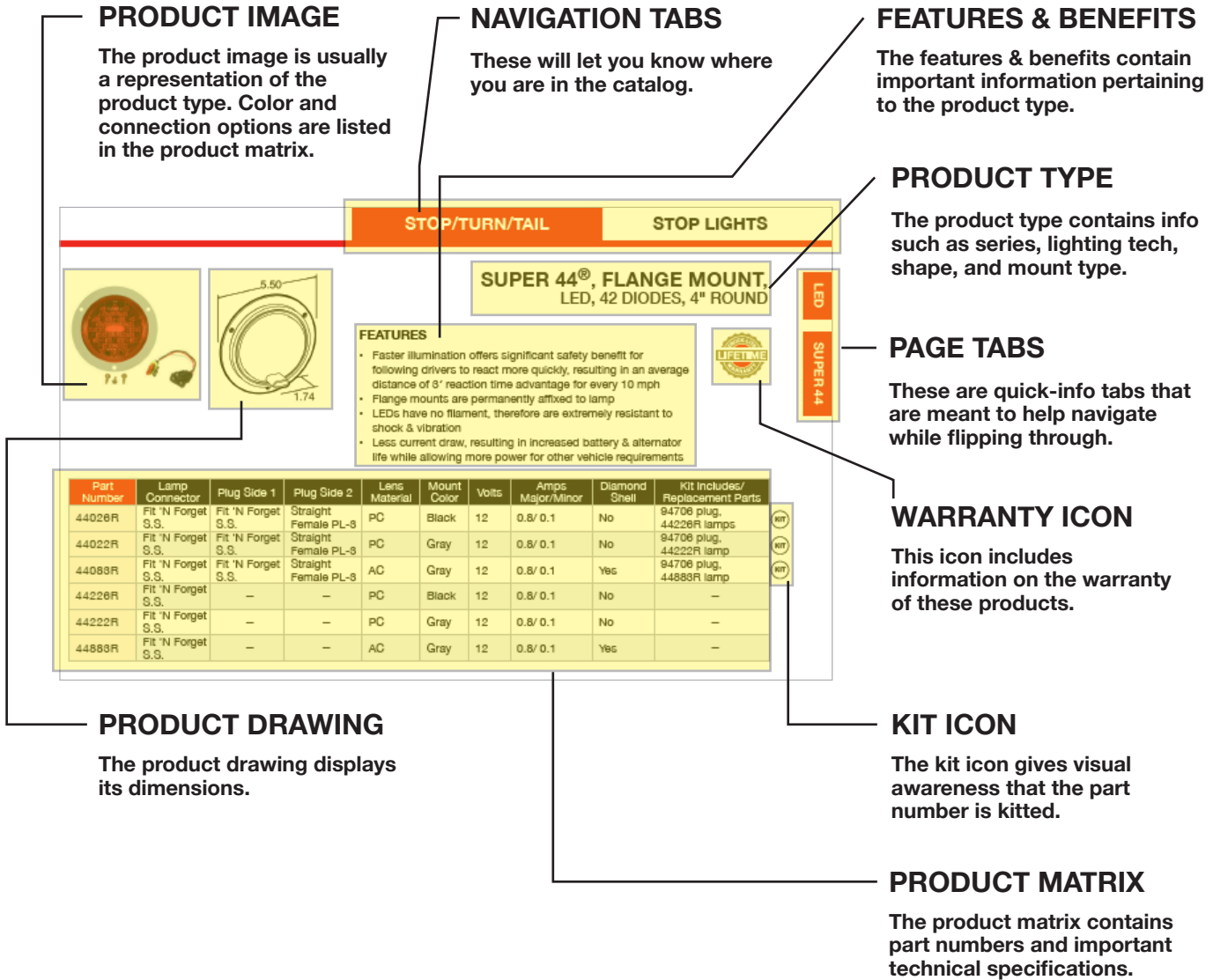

FYI: Common Abbreviations

S.S = SURE SEAL







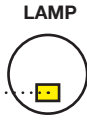
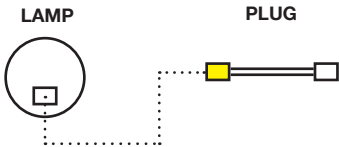
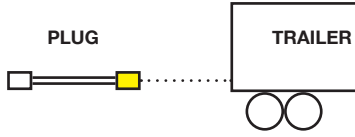





















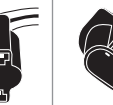





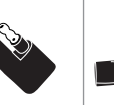
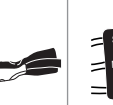

PC = POLYCARBONATE

AC = ACRYLIC

Lamp Connector, Plug Side 1 and Plug Side 2

<h2>Connection Information</h2> <p>When it comes to choosing the correct lamps for your truck or trailer, it's important to know the connection type on your vehicle's harness.</p> <p>If the harness connector type does not match your desired light (lamp connector), you will need a plug to complete the connection.</p>	<p>Lamp Connector</p> <p>The connector type located on the back of a lamp</p> 
	<p>Plug Side 1</p> <p>The connection between a plug and a lamp</p> 
	<p>Plug Side 2</p> <p>The connection between a plug and a trailer's harness</p> 

Common connector types we offer

PL-10 	19 Series Male Pin 	Right Angle PL-3 	Fit 'N Forget S.S. 	Fit 'N Forget M/C 	Right Angle PL-2 	Straight PL-2 	Straight PL-3 	Female Fit 'N Forget S.S. 	Female PL-10 
Female PL-3 	Female PL-2 	Super 21 Plug 	M/C Self Seal 	Male Pin 	Female Male Pin 	19 Series Hot Wire 	Female Right Angle .180 Bullet Terminal 	Female H4 Connector 	H13 Connector 
H5 Connector 	Male H4 Connector 	Ring Terminal with .180 Bullet 	Female .180 Bullet 	Deutsch Connector 	Molded Four Position .180 	2 Position .180 Bullet 	Heat Shrink Splice 	Female TA-1415 	.156 Bullet Shunt 
.180 Bullet/ Ring Terminal 	.180 Bullet 	Ring Terminal / Stripped End 	Stripped End 	.156 Bullet 	Female .156 Bullet 	Blunt Cut 			

Product Attribute Definitions

These terms are used throughout this catalog. Here is what they all mean.

ATTRIBUTE	DEFINITION
Beacon Frequency (FPM)	The number of times a beacon flashes per minute
Beam Pattern	Light pattern type (spot, work, flood)
Breakout	Plug types that branch off from the primary harness
Bulb Wattage (W)	The specific wattage of a bulb
Center Distance (in)	Distance between plugs in inches
Common Size (in)	The general size of a product in inches
Compatible Conductor Size Range – Max	The largest compatible wire size
Compatible Conductor Size Range – Min	The smallest compatible wire size
Current Major (AMP)	Current used for a light’s “high” function measured in amps
Current Minor (AMP)	Current used for a light’s “low” function measured in amps
Current (AMP)	Electric current measured in amps
DB Level	Sound level of a back-up alarm measured in decibels
DB Level – Max	The maximum sound level of a back-up alarm measured in decibels
DB Level – Min	The minimum sound level of a back-up alarm measured in decibels
Diamond Shell (Y/N)	Durable, protective lens coating
Flasher Mechanism	Type of flasher: electro-mechanical, heavy duty solid state, thermal or solid-state
Flashing Patterns	The number of times a strobe flashes in a series (dual or quad)
Lamp Connection	A light’s integral electrical connection type—identifying the plug type required
Light Intensity (CP)	The power emitted by a light source, measured in candelas

ATTRIBUTE	DEFINITION
Lighting Technology	The method by which light is produced (LED, halogen, incandescent)
Mount Type	Method by which a lamp is mounted
Number of Plugs	The number of terminations on a harness
Open/Close	Open or closed-back grommet
Plug Side One	The side of a plug that usually mates directly with the light
Plug Side Two	The side of a plug that usually mates directly with the harness
Series	Product line, usually distinguished by product shape, size, function or technology
Sound Regulation	Single or self-adjusting sound volume
Split/Solid Pin	Pin construction
Standards Met	The regulations/certifications with which a product is designed to comply
Strobe Frequency – Max FPM	A strobe lamp's maximum number of flashes per minute
Strobe Frequency – Min FPM	A strobe lamp's minimum number of flashes per minute
Strobe Frequency (FPM)	A strobe lamp's number of flashes per minute
Warning Class	The SAE classification system for warning lights
Lumens_LM	Light intensity measure in lumens
Maximum Reflective Intensity_CP	Reflective intensity measured in candela power
Metalized/Non-Metalized	Metalized reflector is brighter
Mirror Connection	A plug that fits a type of Mirror

TABLE OF CONTENTS

Stop Lighting	8-45
Stop/Turn/Tail	12-33
Stop/Turn/Tail+Back-Up	34-37
High-Mounted Stop Lights	38-40
Combination Box Lights	41-45

Signal Lighting	46-87
Turn Signal Lights	50-65
Front/Park/Turn	65-74
Long Life Vehicle (LLV)	75
Pedestal Lights	76-87

Light Modules	88-95
----------------------	--------------

Marker & Clearance Lighting	96-153
--	---------------

Identification Bars	154-161
----------------------------	----------------

Personal Trailer Kits	162-167
------------------------------	----------------

License & Back-Up Lighting	168-191
License Lights	172-178
Back-Up Lights	179-190

Work Lights	192-211
--------------------	----------------

Headlights & Fog Lights	212-241
Headlights	218-227
Fog & Driving Lights	228-233
Snow Plow Lights	234-241

Warning & Emergency Lighting	242-267
Warning Lights	246-253
Beacons	254-265
Light Bars	266
Traffic Control Light Bars	267

Interior Utility & Dome Lights	268-285
---	----------------

Lighting Replacement Parts	286-313
Replacement Lenses	288-296
Replacement Bulbs	298-300
Strobe Motors & Rotators	301
Strobe Mounting Magnets	302
Strobe Power Supplies	303
Flasher Modules	304-311
Relays	312-313

Light Mounting	314-355
Light Housing	316-317
Light Mounting Brackets & Flanges	318-344
Light Mounting Gaskets	344-345
Light Mounting Hardware	345-349
Grommet Mounts	350-355

Harness	356-409
Plugs	360-375
Sockets	376-377
Strings	378-379
Harness Systems	380-397
Junction Boxes	398-399
Heat Shrink Tubing	399
Fuses	400
Junction Box Accessories	400-401
Wire Splices	402
Conductor Fittings & Clips	402-403
Nose Boxes	404
Nose Box Accessories	405-406
Receptacles	406-407
Trailer Cords	408
Trailer Connector Cable Plugs	409

Mirrors & Brackets	410-437
Combination Mirrors	412
West Coast Mirrors	412-418
Flat Mirrors	418-426
Convex Mirrors	426-433
Mirror Brackets & Accessories	434-437

Reflectors & Reflective Tape	438-445
Reflectors	440-443
Reflective Tape	443-445
Warning Triangles	445

Maintenance	446-453
Anti-Corrosion Compounds	450
Tester Kits & Accessories	451-452
Light Repair Kits	453

Alarms & Switches	454-465
Back-Up Alarms	456-459
Back-Up Switches	459
Turn Signal Switches	460-465
Universal Switches	465

Merchandising	466-477
Display Racks & Accessories	468-471
Lighted Displays	472-476
Shop Floor Cabinets	477

Technical Information	480-512
------------------------------	----------------

Numerical Index	513-535
------------------------	----------------

STOP LIGHTS

STOP / TURN /TAIL

Pages 12-33

Shape	Common Size	Page
ROUND		12-24
	4"	12-23
	7"	23-24
SQUARE		25
	7 x 7"	25
OVAL		25-30
	2 x 6"	25-30
RECTANGULAR		30-33
	3 x 4"	30
	3 x 5"	31-33
	4 x 6"	33

STOP / TURN /TAIL + BACK-UP

Pages 34-37

Shape	Common Size	Page
ROUND		34-35
	4"	34-35
OVAL		36-37
	2 x 6"	36-37

HIGH-MOUNTED STOP LIGHTS

Pages 38-40

Shape	Common Size	Page
ROUND		38
	4"	38
OVAL		38-39
	2 x 6"	38-39
	1 x 9"	39
RECTANGULAR		40
	2 x 6"	40
	3 x 5"	40

COMBINATION BOX LIGHTS

Pages 41-45

Shape	Series	Page
RECTANGULAR		41-45
	2 Stud Mount-Mack	41
	2 Stud Mount-Ford/Dodge	41
	3 Stud Mount (Led)	41
	Ford	42
	Freightliner	43
	Freightliner/Peterbilt/GM	43
	Freightliner/Peterbilt/Oshkosh	43
	Navistar	44
	Volvo	45





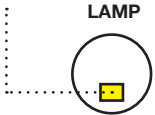
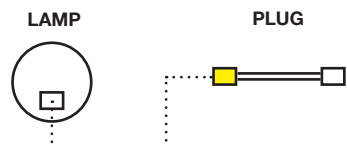
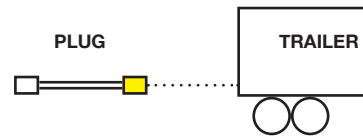

Stop Lights

Whether your vehicle calls for a classic stop/turn/tail lamp or a combination box lamp, Truck-Lite has the right size, shape, material, mount and connection type for any application.

<p>Shapes</p>	<p>Round, Oval, Rectangular, Square</p>
<p>Mount Types</p>	<p>Grommet, Flange, 2 Screw, 4 Screw</p>
<p>Connection Information</p> <p>When it comes to choosing the correct lamps for your truck or trailer, it's important to know the connection type on your vehicle's harness.</p> <p>If the harness connector type does not match your desired light (lamp connector), you will need a plug to complete the connection.</p>	<p>Lamp Connector</p> <p>The connector type located on the back of a lamp</p>  <p>Plug Side 1</p> <p>The connection between a plug and a lamp</p>  <p>Plug Side 2</p> <p>The connection between a plug and a trailer's harness</p> 

(800) 562-5012 | truck-lite.com

 <p>Manufacturing & Quality</p>	 <p>Testing & Safety</p>
<p>Truck-Lite's LED stop/turn/tail lighting is built using premium materials and backed by industry-leading warranties.</p> <p>Designed to last the life of your vehicle, Truck-Lite's solid-state construction and sealed circuitry mean that you can depend on your lighting to withstand shock, vibration, moisture and debris.</p>	<p>All Truck-Lite lamps are subjected to rigorous environmental, electrical and mechanical testing before they are validated and released to the market.</p> <p>All lamps comply with FMVSS/CMVSS-108, SAE and DOT standards when properly mounted.</p>
 <p>Performance & Maintenance</p>	 <p>Customer Support</p>
<ul style="list-style-type: none"> • LEDs are lower energy consumption • Impact-resistant, non-yellowing lenses and rugged housing protect against damage from even the toughest applications • Robust, cost-effective design 	<p>Customer Service</p> <p>(800) 562-5012 customerservice@truck-lite.com</p> <p>Technical Support</p> <p>(888) 562-5012 tltech@truck-lite.com</p> <p>S/T/T Light Warranties</p> 
<p>(800) 562-5012 truck-lite.com</p>	

SUPER 44[®], GROMMET MOUNT LED, 6 DIODE, 4" ROUND



FEATURES

- Faster illumination offers significant safety benefit for following drivers to react more quickly, resulting in an average distance of 3' reaction time advantage for every 10 mph
- LEDs have no filament, therefore are extremely resistant to shock & vibration
- Less current draw, resulting in increased battery & alternator life while allowing more power for other vehicle requirements



44302R



44030R - KIT

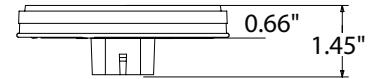

Part Number	Lamp Connector	Plug Side 1	Plug Side 2	Lens Material	Mount Color	Volts	Amps Major/Minor	Diamond Shell	Kit Includes
44302R	Fit 'N Forget S.S.	-	-	PC	-	12	0.24 / 0.03	No	-
44030R	Fit 'N Forget S.S.	Fit 'N Forget S.S.	Straight Female PL-3	PC	Black	12	0.24 / 0.03	No	44302R lamp, 40700 grommet, 94706 plug (KIT)
44982R	Fit 'N Forget S.S.	-	-	AC	-	12	0.24 / 0.03	Yes	-
44092R	Fit 'N Forget S.S.	Fit 'N Forget S.S.	Straight Female PL-3	AC	Black	12	0.24 / 0.03	Yes	44982R lamp, 4700 grommet, 94706 plug (KIT)
44332R	Fit 'N Forget S.S.	-	-	AC	-	12	0.24 / 0.03	No	-

SUPER 44[®], HARDWIRED GROMMET MOUNT, LED, 6 DIODE, 4" ROUND,



FEATURES

- Faster illumination offers significant safety benefit for following drivers to react more quickly, resulting in an average distance of 3' reaction time advantage for every 10 mph
- design results in decreased depth compared to integral plug versions, allowing for mounting in confined spaces
- LEDs have no filament, therefore are extremely resistant to shock & vibration, a major cause of failure for lamps with incandescent bulbs
- Less current draw, resulting in increased battery & alternator life while allowing more power for other vehicle requirements

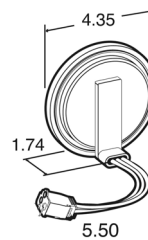

Part Number	Lamp Connector	Plug Side 1	*Plug Side 2	Lens Material	Volts	Amps Major/Minor	Diamond Shell
44350R	Hardwired	Hardwired	Stripped End	PC	12	0.24 / 0.03	No
44351R	Hardwired	Hardwired	Straight Female PL-3	PC	12	0.24 / 0.03	No
44353R	Hardwired	Hardwired	Fit 'N Forget S.S.	PC	12	0.24 / 0.03	No
44355R	Hardwired	Hardwired	Male Pin	PC	12	0.24 / 0.03	No
44959R	Hardwired	Hardwired	Stripped End	AC	12	0.24 / 0.03	Yes
44960R	Hardwired	Hardwired	Straight Female PL-3	AC	12	0.24 / 0.03	Yes
44974R	Hardwired	Hardwired	Male Pin	AC	12	0.24 / 0.03	Yes

*Page 3 for plug visuals

NEW
HEAT  D

Super 44[®] & 60[®] Series
now available

PREVENT ICE AND SNOW BUILDUP IN EVEN THE MOST SEVERE WINTER WEATHER.

The new heated Super 44[®] and 60[®] Series LED stop/turn/tail lamps offer signature Truck-Lite styling, rugged construction and a five-year warranty – now with a heating element that consistently warms the lamp as temperatures fall.



SUPER 44[®], HEATED GROMMET MOUNT, LED, 6 DIODE, 4" ROUND

HEATED



FEATURES

- The new heated LED stop/turn/tail lamp offers signature Truck-Lite styling
- Rugged construction
- Heating element that consistently warms the lamp as temperatures fall, preventing ice and snow buildup in even the most severe winter weather.

Part Number	Lamp Connector	Plug Side 1	Plug Side 2	Lens Material	Lens Color	Mount Color	Volts	Amps Major/Minor
44602R	3-pin Amp	3-pin Amp	Integral Plug	PC	Red	Black	12.8	Tail: 1.025 Stop: 1.150



SUPER 44[®], FLANGE MOUNT LED, 6 DIODE, 4" ROUND



FEATURES

- Faster illumination offers significant safety benefit for following drivers to react more quickly, resulting in an average distance of 3' reaction time advantage for every 10 mph
- Flange mounts are permanently affixed to lamp
- LEDs have no filament, therefore are extremely resistant to shock & vibration
- Less current draw, resulting in increased battery & alternator life while allowing more power for other vehicle requirements

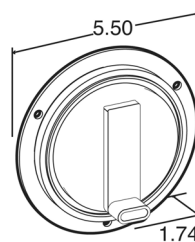

Part Number	Lamp Connector	Plug Side 1	Plug Side 2	Lens Material	Mount Color	Volts	Amps Major/Minor	Diamond Shell	Kit Includes/ Replacement Parts
44322R	Fit 'N Forget S.S.	-	-	PC	Gray	12	0.24 / 0.03	No	-
44032R	Fit 'N Forget S.S.	Fit 'N Forget S.S.	Straight Female PL-3	PC	Gray	12	0.24 / 0.03	No	44322R lamp, 94706 plug
44334R	Fit 'N Forget S.S.	-	-	PC	Silver	12	0.24 / 0.03	No	-
44034R	Fit 'N Forget S.S.	Fit 'N Forget S.S.	Straight Female PL-3	PC	Silver	12	0.24 / 0.03	No	44334R lamp, 94706 plug, 97334 security flange
44326R	Fit 'N Forget S.S.	-	-	PC	Black	12	0.24 / 0.03	No	-
44036R	Fit 'N Forget S.S.	Fit 'N Forget S.S.	Straight Female PL-3	PC	Black	12	0.24 / 0.03	No	44326R lamp, 94706 plug
44328R	Fit 'N Forget S.S.	-	-	PC	White	12	0.24 / 0.03	No	-
44038R	Fit 'N Forget S.S.	Fit 'N Forget S.S.	Straight Female PL-3	PC	White	12	0.24 / 0.03	No	44328R lamp, 94706 plug
44983R	Fit 'N Forget S.S.	-	-	AC	Gray	12	0.24 / 0.03	Yes	-
44986R	Fit 'N Forget S.S.	-	-	AC	Black	12	0.24 / 0.03	Yes	-
44988R	Fit 'N Forget S.S.	-	-	AC	White	12	0.24 / 0.03	Yes	-

KIT

KIT

KIT

KIT

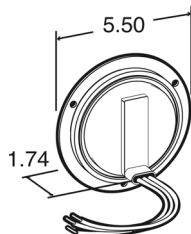

SUPER 44[®], HARDWIRED, LED
6 DIDOE, FLANGE MOUNT, 4" ROUND,



FEATURES

- Faster illumination offers significant safety benefit for following drivers to react more quickly, resulting in an average distance of 3' reaction time advantage for every 10 mph
- Flange mounts are permanently affixed to lamp
- 6 Diodes
- LEDs have no filament, therefore are extremely resistant to shock & vibration
- Less current draw, resulting in increased battery & alternator life while allowing more power for other vehicle requirements

Part Number	Lamp Connector	Plug Side 1	Plug Side 2	Lens Material	Mount Color	Volts	Amps Major/Minor	Diamond Shell
44356R	Hardwired	Hardwired	Stripped End	PC	White	12	0.24 / 0.03	No
44360R	Hardwired	Hardwired	Packard Connector	PC	White	12	0.24 / 0.03	No
44362R	Hardwired	Hardwired	Stripped End	PC	Gray	12	0.24 / 0.03	No
44363R	Hardwired	Hardwired	Straight Female PL-3	PC	Gray	12	0.24 / 0.03	No
44365R	Hardwired	Hardwired	Fit 'N Forget S.S.	PC	Gray	12	0.24 / 0.03	No
44366R	Hardwired	Hardwired	Packard Connector	PC	Gray	12	0.24 / 0.03	No
44954R	Hardwired	Hardwired	Straight Female PL-3	AC	Gray	12	0.24 / 0.03	Yes

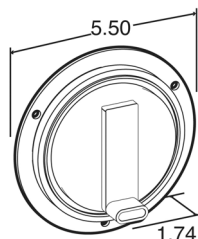

SUPER 44[®], HEATED
FLANGE MOUNT, LED,
6 DIODE, 4" ROUND



FEATURES

- The new heated LED stop/turn/tail lamp offers signature Truck-Lite styling
- Rugged construction
- Heating element that consistently warms the lamp as temperatures fall, preventing ice and snow buildup in even the most severe winter weather.

Part Number	Lamp Connector	Plug Side 1	Plug Side 2	Lens Material	Lens Color	Mount Color	Volts	Amps Major/Minor
44622R	3-pin Amp	3-pin Amp	Integral Plug	PC	Red	Grey	12.8	Tail: 1.025 Stop: 1.150

Look for the Iconic Pentastar Pattern.

upgraded look now available:

- IMPROVED OPTICS
- SLIM PROFILE
- LOWER POWER DRAW



TESTED. TRUSTED. TOUGH.

LED

SUPER 44

**SUPER 44® , LED, 24V,
GROMMET MOUNT, 17 DIODES, 4" ROUND**



FEATURES

- Faster illumination offers significant safety benefit for following drivers to react more quickly, resulting in an average distance of 3' reaction time advantage for every 10 mph
- LEDs have no filament, therefore are extremely resistant to shock & vibration
- Less current draw, resulting in increased battery & alternator life while allowing more power for other vehicle requirements

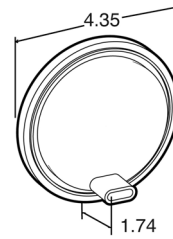

Part Number	Lamp Connector	Lens Material	Volts	Amps Major/Minor	Diamond Shell
44253R	Fit 'N Forget S.S.	PC	24	0.13 / 0.04	No

LED

SUPER 44

**SUPER 44® , LED, 24V,
FLANGE MOUNT, 17 DIODES, 4" ROUND**



FEATURES

- Faster illumination offers significant safety benefit for following drivers to react more quickly, resulting in an average distance of 3' reaction time advantage for every 10 mph
- Flange mounts are permanently affixed to lamp
- LEDs have no filament, therefore are extremely resistant to shock & vibration
- Less current draw, resulting in increased battery & alternator life while allowing more power for other vehicle requirements

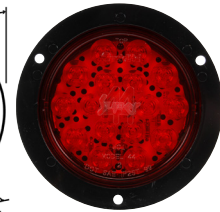
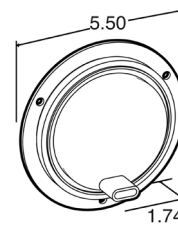

Part Number	Lamp Connector	Lens Material	Mount Color	Volts	Amps Major / Minor	Diamond Shell
44266R	Fit 'N Forget S.S.	PC	Black	24	0.13 / 0.04	No

LED

SUPER 44

**SUPER 44® , GROMMET MOUNT,
LED, 42 DIODES, 4" ROUND**



FEATURES

- Faster illumination offers significant safety benefit for following drivers to react more quickly, resulting in an average distance of 3' reaction time advantage for every 10 mph
- LEDs have no filament, therefore are extremely resistant to shock & vibration
- Less current draw, resulting in increased battery & alternator life while allowing more power for other vehicle requirements



Part Number	Lamp Connector	Plug Side 1	Plug Side 2	Lens Material	Mount Color	Volts	Amps Major/Minor	Diamond Shell	Kit Includes/ Replacement Parts
44202R	Fit 'N Forget S.S.	—	—	PC	Black	12	0.5 / 0.1	No	—
44002R	Fit 'N Forget S.S.	Fit 'N Forget S.S.	Straight Female PL-3	PC	Black	12	0.5 / 0.1	No	44202R lamp, 4700 grommet, 94706 plug (KIT)
44882R	Fit 'N Forget S.S.	—	—	AC	Black	12	0.5 / 0.1	Yes	—
44082R	Fit 'N Forget S.S.	Fit 'N Forget S.S.	Straight Female PL-3	AC	Black	12	0.8 / 0.1	Yes	44882R lamp, 40700 grommet, 94706 plug (KIT)

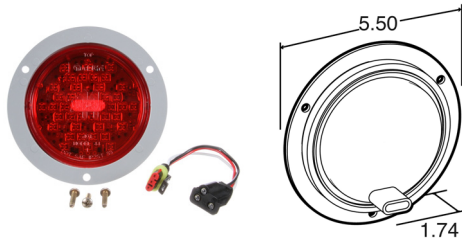

SUPER 44[®], FLANGE MOUNT, LED, 42 DIODES, 4" ROUND

FEATURES

- Faster illumination offers significant safety benefit for following drivers to react more quickly, resulting in an average distance of 3' reaction time advantage for every 10 mph
- Flange mounts are permanently affixed to lamp
- LEDs have no filament, therefore are extremely resistant to shock & vibration
- Less current draw, resulting in increased battery & alternator life while allowing more power for other vehicle requirements



LED
SUPER 44

Part Number	Lamp Connector	Plug Side 1	Plug Side 2	Lens Material	Mount Color	Volts	Amps Major/Minor	Diamond Shell	Kit Includes/ Replacement Parts
44222R	Fit 'N Forget S.S.	-	-	PC	Gray	12	0.8/ 0.1	No	-
44022R	Fit 'N Forget S.S.	Fit 'N Forget S.S.	Straight Female PL-3	PC	Gray	12	0.8/ 0.1	No	44222R lamp, 94706 plug
44226R	Fit 'N Forget S.S.	-	-	PC	Black	12	0.8/ 0.1	No	-
44026R	Fit 'N Forget S.S.	Fit 'N Forget S.S.	Straight Female PL-3	PC	Black	12	0.8/ 0.1	No	44226R lamps, 94706 plug
44883R	Fit 'N Forget S.S.	-	-	AC	Gray	12	0.8/ 0.1	Yes	-
44083R	Fit 'N Forget S.S.	Fit 'N Forget S.S.	Straight Female PL-3	AC	Gray	12	0.8/ 0.1	Yes	44883R lamp, 94706 plug

KIT

KIT

KIT

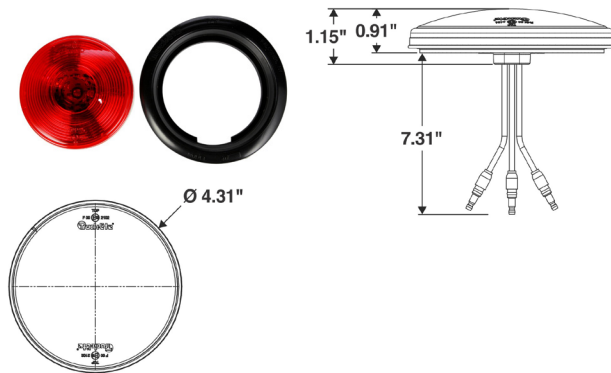

44[®] SERIES, HARDWIRED, GROMMET MOUNT, LED, 1 DIODE, 4" ROUND, ECE

FEATURES

- Electronics completely sealed in epoxy to resist moisture & corrosion
- Lamp hardwired - wire leads incorporate .180 jacketed bullet terminals
- Sealed polycarbonate lens & housing
- Voltage 10V to 30V



LED
SUPER 44

Part Number	Lamp Connector	Plug Side 1	Plug Side 2	Lens Material	Mount Color	Volts	Amps Major/Minor	Kit Includes/ Replacement Parts
44121R	Hardwired	Hardwired	.180 Bullet	PC	Black	12 24	0.23 / 0.02	44932R lamp, 40700 grommet
44932R	Hardwired	Hardwired	.180 Bullet	PC		13.5	0.36 / 0.036	ECE

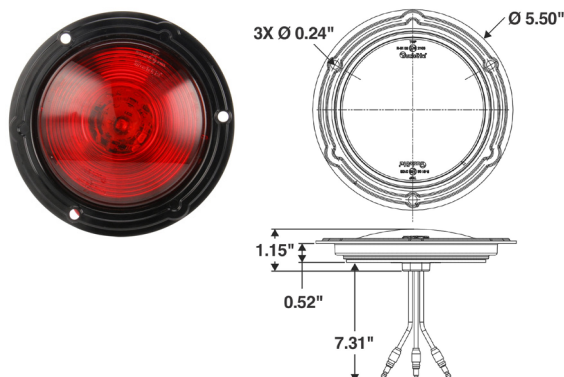

44[®] SERIES, HARDWIRED, FLANGE MOUNT, LED, 1 DIODE, 4" ROUND, ECE

FEATURES

- Electronics completely sealed in epoxy to resist moisture & corrosion
- Lamp hardwired - wire leads incorporate .180 jacketed bullet terminals
- Sealed polycarbonate lens & housing
- Voltage 10V to 30V



LED
SUPER 44

Part Number	Lamp Connector	Plug Side 1	Plug Side 2	Lens Material	Mount Color	Volts	Amps Major / Minor
44936R	Hardwired	Hardwired	.180 Bullet	PC	Black	12/24	0.36 / 0.036

LED

SIGNAL-STAT

LED, GROMMET MOUNT

4" ROUND, 10 DIODES



FEATURES

- When properly mounted, exceeds FMVSS-P2 DOT requirements for marker/clearance performance
- Designed with impact-resistant acrylic material
- Sealed lens and housing locks moisture out
- LEDs do not have a filament, therefore are not susceptible to shock and vibration damage major cause of failure for lamps with an incandescent bulb

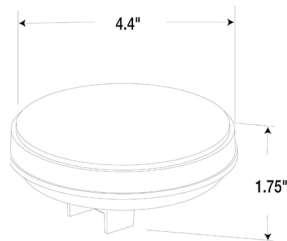

Part Number	Lamp Connector	Lens Material	Volts	Amps Major/Minor
4058	PL-3	AC	12	0.12 / 0.02

LED

SIGNAL-STAT

LED, GROMMET MOUNT

24 DIODES, 4" ROUND



FEATURES

- Epoxy encapsulated electronics prevents damage from moisture & corrosion
- Unique LED array displays a full pattern light output design
- Uses standard right angle connection

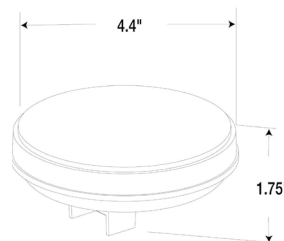

Part Number	Lamp Connector	Lens Material	Lens Color	Volts	Amps Major/Minor
4050	PL-3	PC	Red	12	0.14 / 0.01
4051	PL-3	PC	Red Clear	12	0.14 / 0.01

LED

SIGNAL-STAT

LED, FLANGE MOUNT,

24 DIODES, 4" ROUND



FEATURES

- Uses standard right angle PL-3 connection
- Designed with impact-resistant polycarbonate material
- LEDs do not have a filament, therefore are not susceptible to damage from shock and vibration
- When properly mounted, exceeds FMVSS DOT requirements for S/T/T

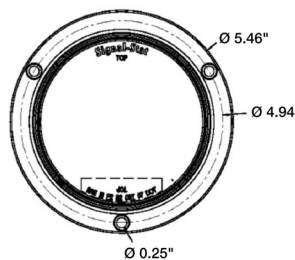

Part Number	Lamp Connector	Lens Material	Mount Color	Volts	Amps Major/Minor
4053	PL-3	PC	Gray	12	0.14 / 0.01

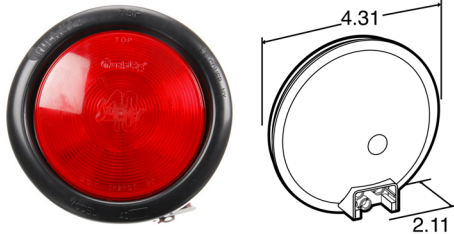

SUPER 40[®], INCANDESCENT, GROMMET MOUNT, 4" ROUND

FEATURES

- 12 Square inch Illuminating Stop/ Turn Lens for Vehicles 80 or More inches wide for all lamps except with those with integrated Reflex lenses
- Flush-mount grommets are designed for mounting in a 4 1/2" hole
- Uniquely designed shock-mount extends lamp life
- Upgrade to LED lighting systems using Truck-Lite's Super 44 series



Part Number	Lamp Connector	Plug Side 1	Plug Side 2	Lens Material	Mount Color	Volts	Amps Major/Minor	Kit Includes/ Replacement Parts
40242R	PL-3	–	–	PC	–	12	2.16/0.47	–
40042R	PL-3	Right Angle PL-3	Stripped End/ Ring Terminal	PC	Black	12	2.16/0.47	40242R lamp, 40700 grommet, 94993 plug

KIT



SUPER 40[®], REFLECTORIZED, INCANDESCENT, GROMMET MOUNT, 4" ROUND,

FEATURES

- 8 square inch (illuminating) stop/turn lens area for vehicles under 80 inches wide
- Meets reflex, tail or clearance function for vehicles over 80 inches wide (Use part# 40248R)
- Flush-mount grommets are designed for mounting in a 4 1/2" hole
- Uniquely designed shock-mount extends lamp life



Part Number	Lamp Connector	Plug Side 1	Plug Side 2	Lens Material	Mount Color	Volts	Amps Major/Minor	Kit Includes/ Replacement Parts
40248R	PL-3	–	–	PC	–	12	2.16/0.47	–
40048R	PL-3	Right Angle PL-3	Stripped End/ Ring Terminal	PC	Black	12	2.16/0.47	40248R lamp, 40700 grommet, 94993 plug

KIT

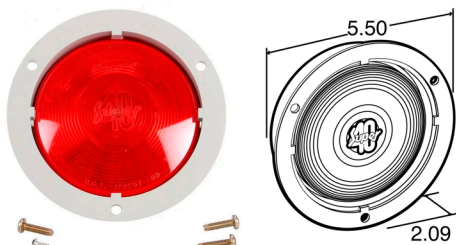

SUPER 40[®], INCANDESCENT, FLANGE MOUNT, 4" ROUND

FEATURES

- Uniquely designed shock-mount extends lamp life



Part Number	Lamp Connector	Plug Side 1	Plug Side 2	Lens Material	Mount Color	Volts	Amps Major/Minor	Kit Includes/ Replacement Parts
40258R	PL-3	–	–	PC	–	12	2.16/0.47	–
40058R	PL-3	Right Angle PL-3	Stripped End/ Ring Terminal	PC	Gray	12	2.16/0.47	40258R lamp, 94993 plug
40259R	PL-3	–	–	PC	Black	12	2.16/0.47	–

KIT

40[®] SERIES, INCANDESCENT, GROMMET MOUNT, 4" ROUND



FEATURES

- Shock mount absorbs road shock & vibration, extending lamp life
- Welded connections eliminate failures caused by arcing
- Heavy-duty bulb offers long-lasting life
- Grommet kit features flush mounting in a 4-1/2" hole
- Not recommended for clearance marker applications
- Welded connections eliminate failures caused by arcing

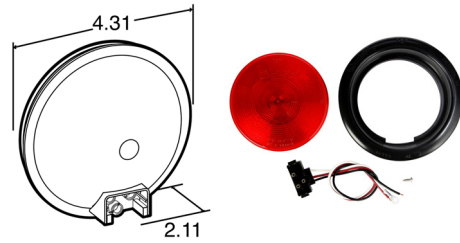

Part Number	Lamp Connector	Plug Side 1	Plug Side 2	Lens Material	Mount Color	Volts	Amps Major/Minor	Kit Includes/ Replacement Parts
40202R	PL-3	—	—	PC	Black	12	2.1/0.48	—
40002R	PL-3	Right Angle PL-3	Stripped End/ Ring Terminal	PC	Black	12	2.1/0.48	40202R lamp, 40700 grommet, 94993 plug KIT
40209R	PL-3	—	—	PC	Black	24	0.93/0.34	—
40009R	PL-3	Right Angle PL-3	Stripped End/ Ring Terminal	PC	Black	24	0.1/0.36	40209R lamp, 40700 grommet, 94993 plug KIT
49202R	Male Pin	—	—	PC	Black	12	2.1/0.48	—
49002R	Male Pin	Male Pin	Stripped End/ Ring Terminal	PC	Black	12	2.1/0.48	49202R lamp, 40700 grommet, 96107 plug KIT

40[®] SERIES, INCANDESCENT, GROMMET MOUNT, SNAP-FIT, 4" ROUND



FEATURES

- Replaces 40302R/Y and 40318R/Y
- Polycarbonate lens and housing
- Grommet features flush mounting in a 4-1/2" hole

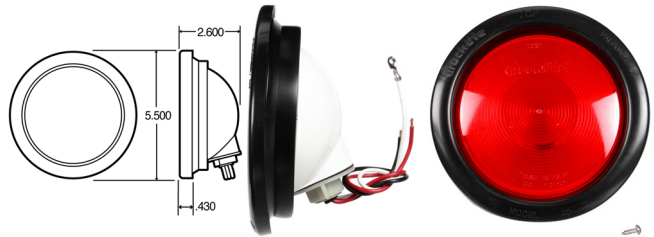

Part Number	Lamp Connector	Plug Side 1	Plug Side 2	Lens Material	Mount Color	Volts	Amps Major/Minor	Kit Includes/ Replacement Parts
40302R	Twist Socket	Twist Socket	Stripped End/ Ring Terminal	PC	Black	12	2.1/0.48	40700 grommet, 94938 bulb/plug, 99010R housing KIT

40[®] SERIES, CLEAR BACK, INCAN., GROMMET MOUNT, 4" ROUND



FEATURES

- Features clear back housing
- Shock mount absorbs road shock & vibration, extending lamp life
- Welded connections eliminate failures caused by arcing
- Heavy-duty bulb offers long-lasting life
- Uniquely designed shock-mount extends lamp life
- Not recommended for clearance marker applications
- Welded connections eliminate failures caused by arcing

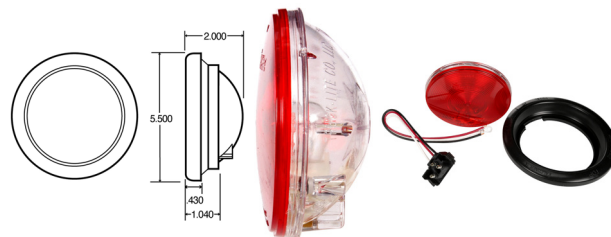

Part Number	Lamp Connector	Plug Side 1	Plug Side 2	Lens Material	Mount Color	Volts	Amps Major/Minor	Kit Includes/ Replacement Parts
40206R	PL-3	—	—	PC	Black	12	2.1/0.48	—
40006R	PL-3	Right Angle PL-3	Stripped End/ Ring Terminal	PC	Black	12	2.1/0.48	40700 grommet, 94993 plug, 40206R lamp KIT

INCANDESCENT

40 SERIES

INCANDESCENT

40 SERIES

INCANDESCENT

40 SERIES



40[®] SERIES, REFLECTORIZED, GROMMET MOUNT, 4" ROUND

FEATURES

- 8 square inch (illuminating) stop/turn lens area for vehicles under 80 inches wide
- Meets reflex, tail or clearance function for vehicles over 80 inches wide (Use part# 40248R)
- Flush-mount grommets are designed for mounting in a 4 1/2" hole
- Uniquely designed shock-mount extends lamp life
- Upgrade to LED lighting systems using Truck-Lite's Super 44 series



Part Number	Lamp Connector	Plug Side 1	Plug Side 2	Lens Material	Mount Color	Volts	Amps Major/Minor	Kit Includes/ Replacement Parts
40215R	PL-3	–	–	PC	Black	12	2.1/0.48	–
40015R	PL-3	Right Angle PL-3	Stripped End/ Ring Terminal	PC	Black	12	2.1 / 0.48	40215R lamp, 40700 grommet, 94993 plug
40232R	PL-3	–	–	PC	Black	28	0.1/0.36	–

KIT

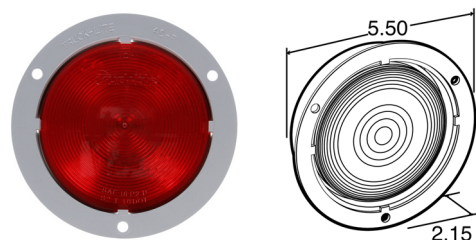

40[®] SERIES, FLANGE MOUNT, 4" ROUND, INCANDESCENT

FEATURES

- Flush mount grommets are designed for mounting in a 4-1/2" hole
- Gray flange mounts are permanently affixed to housing



Part Number	Lamp Connector	Plug Side 1	Plug Side 2	Lens Material	Mount Color	Volts	Amps Major/Minor
40222R	PL-3	–	–	PC	Gray	12	2.1/0.48
40233R	PL-3	Right Angle PL-3	Stripped End/Ring Terminal	PC	Black	12	2.1/0.48

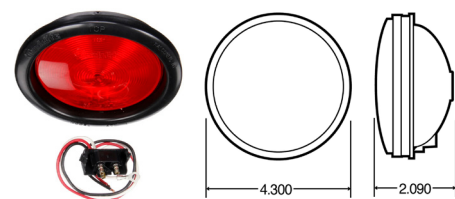

40[®] ECONOMY, GROMMET MOUNT, 4" ROUND, INCANDESCENT

FEATURES

- Flange kits feature a high impact plastic affixed to lamp
- Grommet kit features flush mounting in a 4-1/2" hole



Part Number	Lamp Connector	Plug Side 1	Plug Side 2	Lens Material	Mount Color	Volts	Amps Major/Minor	Kit Includes/ Replacement Parts
40282R	PL-3	–	–	PC	Black	12	2.1/0.48	–
40028R	PL-3	Right Angle PL-3	Stripped End/ Ring Terminal	PC	Black	12	2.1/0.48	40282R lamp, 40700 grommet, 94993 plug

KIT

40[®] ECONOMY, REFLECTORIZED, INCANDESCENT, FLANGE MOUNT, 4" ROUND



FEATURES

- 8 square inch (illuminating) stop/turn lens area for vehicles under 80 inches wide
- Meets reflex, tail or clearance function for vehicles over 80 inches wide
- Flush-mount grommets are designed for mounting in a 4 1/2" hole
- Uniquely designed shock-mount extends lamp life

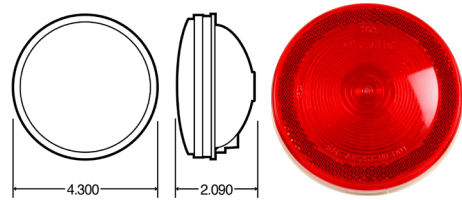

Part Number	Lamp Connector	Lens Material	Volts	Amps Major/Minor
40285R	PL-3	PC	12	2.16/0.47

40[®] ECONOMY, FLANGE MOUNT, 4" ROUND, INCANDESCENT



FEATURES

- Flange kits feature a high impact plastic affixed to lamp
- Grommet kit features flush mounting in a 4-1/2" hole

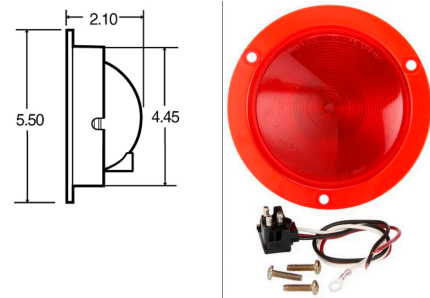

Part Number	Lamp Connector	Plug Side 1	Plug Side 2	Lens Material	Mount Color	Volts	Amps Major/Minor	Kit Includes/ Replacement Parts
40229R	PL-3	—	—	PC		12	2.16/0.47	—
40029R	PL-3	Straight PL-3	Stripped End/ Ring Terminal	PC	Red	12	2.16/0.47	40229R lamp, 94993 plug

(KIT)

80 SERIES, HARDWIRED, FLANGE MOUNT, 4" ROUND, INCANDESCENT



FEATURES

- Mounts flush to vehicle with recessed lens
- Features rubber housing for shock absorbency

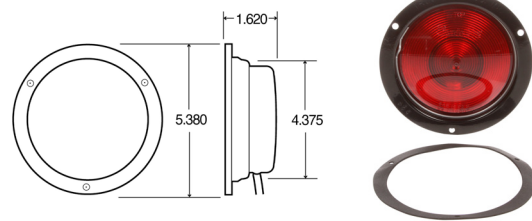

Part Number	Lamp Connector	Plug Side 1	Plug Side 2	Lens Material	Mount Color	Volts	Amps Major/Minor	Kit Includes/ Housing Material
80334R	Hardwired	Hardwired	Blunt Cut	PC	Black	12	2.25/1.44	60283R lamp, 94993 plug, 60700 grommet
80302R	Hardwired	Hardwired	Blunt Cut	AC	Black	12	2.25/1.44	Stainless Steel
80335R	Hardwired	Hardwired	Blunt Cut	PC	Silver	12	2.25/1.44	Unpolished Steel
80336R	Hardwired	Hardwired	Blunt Cut	PC	Silver	12	2.25/1.44	Polished Steel
80339R	Hardwired	Hardwired	Blunt Cut	PC	Black	12	2.25/1.44	—

(KIT)

INCANDESCENT

40 ECONOMY

INCANDESCENT

40 ECONOMY

INCANDESCENT

80 SERIES

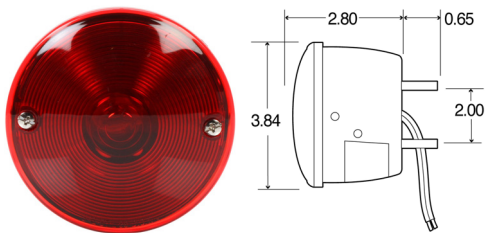

80 SERIES, HARDWIRED, INCAN., STUD MOUNT, 4" ROUND

FEATURES

- Universal or 2 bolt mount 1/4" - 20
- Dual screws secure lens
- #80461/80463 have license lamp windows in housing



Part Number	Lamp Connector	Plug Side 1	Plug Side 2	Lens Material	Lens Color	Mount Color	Mount Type	Volts	Amps Major/Minor
80461R	Hardwired	Hardwired	Stripped End	AC	Red/Clear	Black	Bracket	12	2.25/1.44
80462R	Hardwired	Hardwired	Stripped End	AC	Red	Black	Bracket	12	2.25/1.44
80463R	Hardwired	Hardwired	Stripped End	AC	Red/Clear	Black		12	2.25/1.44

INCANDESCENT

80 SERIES



SIGNAL-STAT, HARDWIRED, INCAN., FLANGE MOUNT, 4" ROUND

FEATURES

- Mounts through 4-1/2" diameter cut-out, 2" depth below flange
- Narrow depth behind flange allows lamp to fit where other lamps cannot
- Uses bulb #1157



Part Number	Lamp Connector	Plug Side 1	Plug Side 2	Lens Material	Mount Color	Volts	Amps Major/Minor	Replacement Parts
3612	Hardwired	Hardwired	Stripped End	AC	Grey	12	2.1/0.5	9101 plug, 9102 plug, 9021 lens
3616	Hardwired	Hardwired	Stripped End	AC	Chrome	12	2.1/0.5	9101 plug, 9102 plug, 9021 lens

INCAN.

SIGNAL-STAT



SIGNAL-STAT, HARDWIRED, INCAN., 2 STUD MOUNT, 4" ROUND

FEATURES

- Two wire
- Uses bulb #1157
- #540 has license lamp window with housing



Part Number	Lamp Connector	Plug Side 1	Plug Side 2	Lens Material	Lens Color	Volts	Amps Major/Minor	Replacement Parts
540	Hardwired	Hardwired	Stripped End	PC	Red/Clear	12	2.1/0.5	9041 lens
541	Hardwired	Hardwired	Stripped End	PC	Red	12	2.1/0.5	9041 lens

INCAN.

SIGNAL-STAT

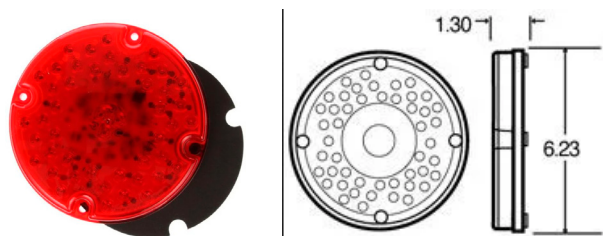

91 SERIES, HARDWIRED LED, 47 DIODE, 7" ROUND, 4 SCREW

FEATURES

- Features over-voltage and spike protection circuitry
- Mounts in any 360 degree application
- Popular in bus applications



Part Number	Lamp Connector	Plug Side 1	Plug Side 2	Lens Material	Volts	Amps Major/Minor
91244R	Hardwired	Hardwired	Stripped End	AC	12	0.50/0.023
91369R	Hardwired	Hardwired	Packard Connector 12015793	AC	13.5	0.54/0.023

LED

60 SEFRRIES

LED

60 SERIES

91 SERIES, REFLECTORIZED, HARDWIRED, LED, 47 DIODE, 7" ROUND, 4 SCREW



FEATURES

- Features over-voltage and spike protection circuitry
- Mounts in any 360 degree application
- Popular in bus applications

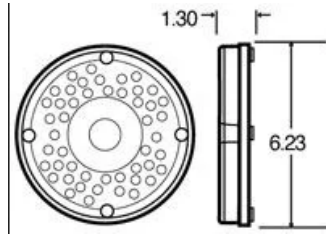

Part Number	Lamp Connector	Plug Side 1	Plug Side 2	Lens Material	Volts	Amps Major/Minor
91242R	Hardwired	Hardwired	Stripped End	AC	13.5	0.54/0.023

INCANDESCENT

90 SERIES

91 SERIES, HARDWIRED, SEALED, 7" ROUND, 4 SCREW



FEATURES

- Popular lamp on buses and emergency vehicles|Requires a 1" diameter hole, 1" deep|Surface mounts with four bolts on a 6.25" bolt circle
- Uses bulb #1157

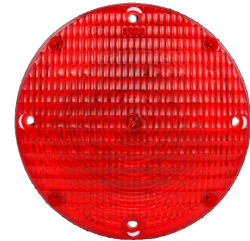
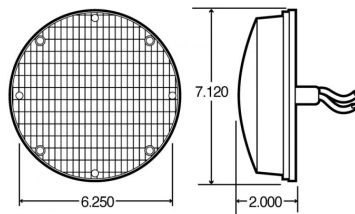

Part Number	Lamp Connector	Plug Side 1	Plug Side 2	Lens Material	Volts	Amps Major/Minor	Kit Includes
90327R	Hardwired	Hardwired	Stripped End	AC	12	2.1/0.50	99168R lens, 9520 gasket

INCANDESCENT

91 SERIES

91[®] SERIES, SEALED, 7" ROUND, 4 SCREW



FEATURES

- Contains a heavy-duty shock mount 12 volt dual filament bulb
- Mounting gasket provides additional protection between lamp & body
- Mounts in a 5.375" hole

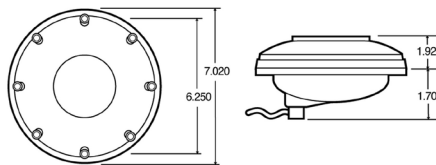

Part Number	Lamp Connector	Plug Side 1	Plug Side 2	Lens Material	Volts	Amps Major/Minor	Kit Includes/ Replacement Parts
91202R	PL-3	-	-	PC	12	2.1/0.48	-
91002R	PL-3	PL-3	Stripped End/Ring Terminal	PC	12	2.1/0.48	91202R lamp, 94993 plug
91205R	PL-3	-	-	PC	24	0.93/0.34	-

INCANDESCENT

91 SERIES

91[®] SERIES, BULB REPLACEABLE, 7" ROUND, 4 SCREW



FEATURES

- Mounting gasket provides additional protection between lamp & body
- Mounts in a 3.84" hole
- Uses #3157K bulb

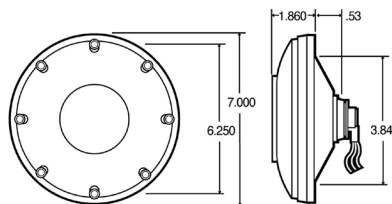

Part Number	Lamp Connector	Plug Side 1	Plug Side 2	Lens Material	Volts	Amps Major/Minor
91315R	Hardwired	Hardwired	Stripped End/Ring Terminal	PC	12	2.1/0.48

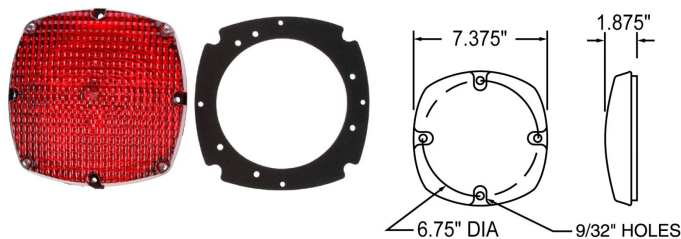

BULB REPLACEABLE
7"X7" SQUARE, 4 SCREW,
INCANDESCENT

FEATURES

- Double optic lens covers black enameled steel housing
- Popular school bus signal lamps
- Positive seal prevents leaking and eliminates cracked lenses
- Rimless lens construction
- Uses bulb #1157



Part Number	Lamp Connector	Plug Side 1	Plug Side 2	Lens Material	Volts	Amps Major/Minor	Replacement Parts
6502	Hardwired	Hardwired	Stripped End/ Ring Terminal	PC	12	2.1/0.50	9382 lens

INCANDESCENT

91 SERIES



SUPER 66, GROMMET MOUNT,
LED, 1 DIODE, 2"X 6" OVAL,

FEATURES

- Designed to look more like a standard incandescent lamp but has more light output
- Less current draw, resulting in increased battery & alternator life while allowing more power for other vehicle requirements
- World's first single side LED stop, turn & tail lamp



Part Number	Lamp Connector	Plug Side 1	Plug Side 2	Lens Material	Mount Color	Volts	Amps Major/Minor	Diamond Shell	Kit Includes/ Replacement Parts
66250R	Fit 'N Forget S.S.	-	-	PC	Black	12	0.47/0.03	No	-
66050R	Fit 'N Forget S.S.	Fit 'N Forget S.S.	Straight Female PL-3	PC	Black	12	0.47/0.03	No	66250R lamp, 60700 grommet, 94706 plug
66885R	Fit 'N Forget S.S.	Fit 'N Forget S.S.	Straight Female PL-3	AC	Black	12	0.47/0.03	Yes	-
66085R	Fit 'N Forget S.S.	Fit 'N Forget S.S.	Straight Female PL-3	AC	Black	12	0.47/0.03	Yes	66885R lamp, 60700 grommet, 94706 plug

LED

SUPER 66

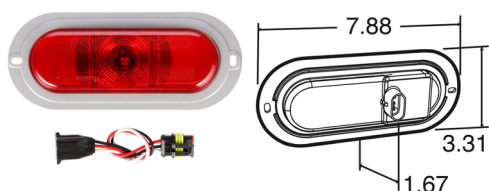

SUPER 66, FLANGE MOUNT,
LED, 1 DIODE, 2"X 6" OVAL

FEATURES

- Designed to look more like a standard incandescent lamp but has more light output
- Less current draw, resulting in increased battery & alternator life while allowing more power for other vehicle requirements
- World's first single side LED stop, turn & tail lamp



Part Number	Lamp Connector	Plug Side 1	Plug Side 2	Lens Material	Mount Color	Volts	Amps Major/Minor	Diamond Shell	Kit Includes/ Replacement Parts
66252R	Fit 'N Forget S.S.	-	-	PC	Gray	12	0.47/0.03	No	-
66052R	Fit 'N Forget S.S.	Fit 'N Forget S.S.	Straight Female PL-3	PC	Gray	12	0.47/0.03	No	66252R lamp, 97406 plug
66254R	Fit 'N Forget S.S.	-	-	PC	White	12	0.47/0.03	No	-
66054R	Fit 'N Forget S.S.	Fit 'N Forget S.S.	Straight Female PL-3	PC	White	12	0.47/0.03	No	66254R lamp, 97406 plug
66256R	Fit 'N Forget S.S.	-	-	PC	Black	12	0.47/0.03	No	-
66056R	Fit 'N Forget S.S.	Fit 'N Forget S.S.	Straight Female PL-3	PC	Black	12	0.47/0.03	No	66256R lamp, 97406 plug
66882R	Fit 'N Forget S.S.	-	-	AC	Gray	12	0.47/0.03	Yes	-
66082R	Fit 'N Forget S.S.	Fit 'N Forget S.S.	Straight Female PL-3	AC	Gray	12	0.47/0.03	Yes	66882R lamp, 97406 plug

LED

SUPER 66

NEW
HEAT  D

Super 44[®] & 60[®] Series

now available

**PREVENT ICE AND SNOW
BUILDUP IN EVEN THE MOST
SEVERE WINTER WEATHER.**

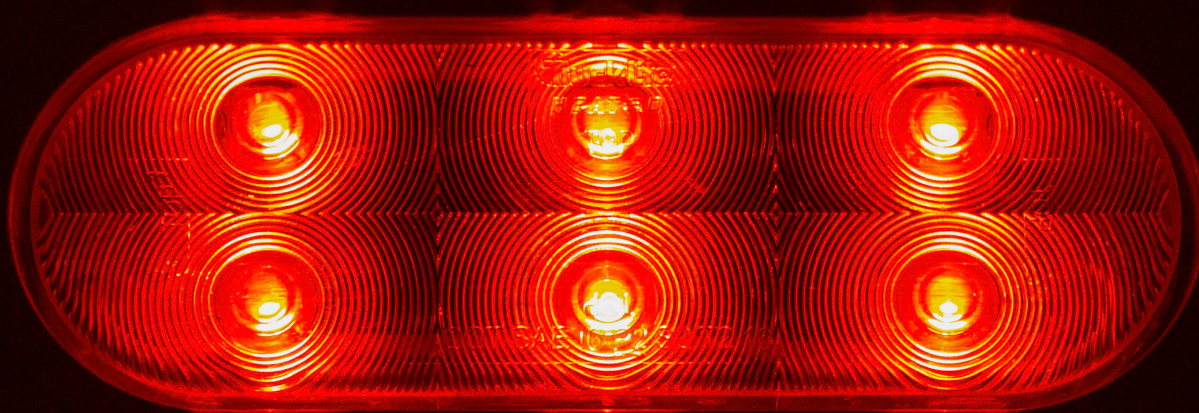

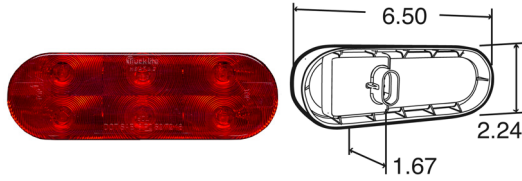

**60[®] SERIES, GROMMET MOUNT,
HEATED,
LED, 6 DIODE, 2"X 6" OVAL,**

HEAT 



FEATURES

- The new heated LED stop/turn/tail lamp offers signature Truck-Lite styling
- Rugged construction
- Heating element that consistently warms the lamp as temperatures fall, preventing ice and snow buildup in even the most severe winter weather.

Part Number	Lamp Connector	Plug Side 1	Plug Side 2	Lens Material	Lens Color	Mount Color	Volts	Amps Major/Minor
60602R	3-pin Amp	3-pin Amp	Integral Plug	PC	Red	Black	13.5	Tail: 1.020 Stop: 1.21

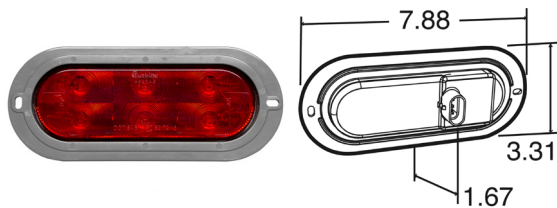

**60[®] SERIES, FLANGE MOUNT,
HEATED,
LED, 6 DIODE, 2"X 6" OVAL,**

HEAT 



FEATURES

- The new heated LED stop/turn/tail lamp offers signature Truck-Lite styling
- Rugged construction
- Heating element that consistently warms the lamp as temperatures fall, preventing ice and snow buildup in even the most severe winter weather.

Part Number	Lamp Connector	Plug Side 1	Plug Side 2	Lens Material	Lens Color	Mount Color	Volts	Amps Major/Minor
60622R	3-pin Amp	3-pin Amp	Integral Plug	PC	Red	grey	13.5	Tail: 1.020 Stop: 1.21

LED

60 SERIES

60[®] SERIES, GROMMET MOUNT LED, 26 DIODES, 2"X 6" OVAL



FEATURES

- Faster illumination offers significant safety benefit for following drivers to react quicker, resulting in average 3' reaction time advantage for every 10 mph

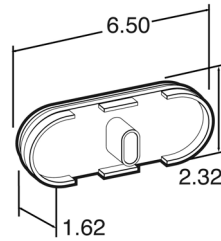

Part Number	Lamp Connector	Plug Side 1	Plug Side 2	Lens Material	Mount Color	Volts	Amps Major/Minor	Diamond Shell	Kit Includes/ Replacement Parts
60250R	Fit 'N Forget S.S.	-	-	PC		12	0.34/0.04	No	-
60050R	Fit 'N Forget S.S.	Fit 'N Forget S.S.	Straight Female PL-3	PC	Black	12	0.34/0.54	No	60250R lamp, 60700 grommet, 94706 plug (KIT)
60885R	Fit 'N Forget S.S.	-	-	AC		12	0.34/0.04	Yes	-
60085R	Fit 'N Forget S.S.	Fit 'N Forget S.S.	Straight Female PL-3	AC	Black	12	0.34/0.04	Yes	60885R lamp, 60700 grommet, 94706 plug (KIT)
60253R	Fit 'N Forget S.S.	-	-	PC		24	0.34/0.04	No	-
60264R	Fit 'N Forget S.S.	-	-	AC		24	0.34/0.04	Yes	-

LED

60 SERIES

60[®] SERIES, FLANGE MOUNT, LED, 26 DIODES, 2"X 6" OVAL



FEATURES

- Faster illumination offers significant safety benefit for following drivers to react more quickly, resulting in average 3' reaction time advantage for every 10 mph

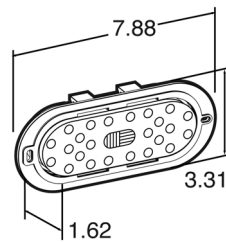

Part Number	Lamp Connector	Plug Side 1	Plug Side 2	Lens Material	Mount Color	Volts	Amps Major/Minor	Diamond Shell	Kit Includes/ Replacement Parts
60252R	Fit 'N Forget S.S.	-	-	PC	Gray	12	0.34/0.04	No	-
60052R	Fit 'N Forget S.S.	Fit 'N Forget S.S.	Straight Female PL-3	PC	Gray	12	0.34/0.54	No	60252R lamp, 94706 plug (KIT)
60256R	Fit 'N Forget S.S.	-	-	PC	Black	12	0.34/0.04	No	-
60056R	Fit 'N Forget S.S.	Fit 'N Forget S.S.	Straight Female PL-3	PC	Black	12	0.34/0.04	No	60256R lamp, 94706 plug (KIT)

LED

SUPER 66

LED, GROMMET MOUNT, 2"X 6" OVAL, 10 DIODES



FEATURES

- When properly mounted, exceeds FMVSS-P2 DOT requirements for marker/clearance performance
- Sealed lens and housing locks moisture out
- LEDs do not have a filament, therefore are not susceptible to damage from shock and vibration

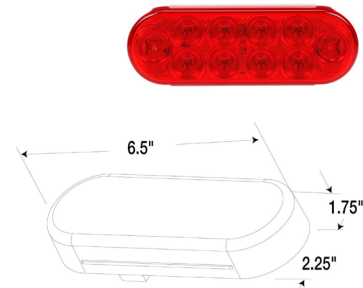

Part Number	Lamp Connector	Lens Material	Volts	Amps Major / Minor
6058	PL-3	AC	12	0.17/0.02

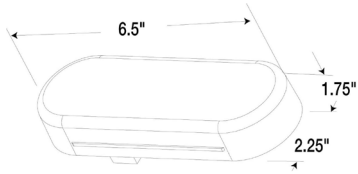

LED, GROMMET MOUNT
24 DIODES, 2"X 6" OVAL



FEATURES

- Epoxy encapsulated electronics prevents damage from moisture & corrosion
- Unique LED array displays full pattern light output design
- Uses standard right angle plug

Part Number	Lamp Connector	Lens Material	Lens Color	Volts	Amps Major / Minor
6050	PL-3	PC	Red	12	0.26/0.02
6051	PL-3	PC	Red Clear	12	0.26/0.02

LED

SIGNAL-STAT

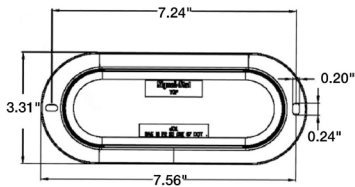

LED, FLANGE MOUNT,
24 DIODES, 2"X 6" OVAL



FEATURES

- Housing and flange are molded together to form one piece
- Uses standard right angle PL-3 connection
- Designed with impact-resistant polycarbonate material
- LEDs do not have a filament, therefore are not susceptible to shock and vibration damage - a major cause of failure for lamps with an incandescent bulb
- Epoxy encapsulated electronics prevents damage from moisture and corrosion
- When properly mounted, exceeds FMVSS DOT requirements for S/T/T

Part Number	Lamp Connector	Lens Material	Mount Color	Volts	Amps Major / Minor
6053	PL-3	PC	Gray	12	0.26/0.02

LED

SIGNAL-STAT

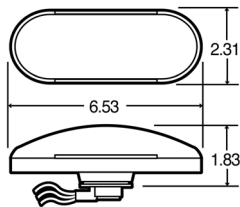

60[®] SERIES, HARDWIRED,
1 BULB, GROMMET MOUNT,
2"X 6" OVAL, KIT

FEATURES

- Lamp may be either grommet or screw-mounted
- Mounts horizontally or vertically



Part Number	Lamp Connector	Plug Side 1	Plug Side 2	Lens Material	Mount Color	Volts	Amps Major/Minor	Kit Includes/ Replacement Parts
60302R	Hardwired	Hardwired	Stripped End/ Ring Terminal	PC	Gray	12	2.1/0.48	60781 lamp, 99011R lamp
60340R	Hardwired	Hardwired	Stripped End/ Ring Terminal	PC	Black	12	2.1/0.48	99184R lamp, 60700 grommet, 95407 bulb

INCANDESCENT

60 SERIES

**60[®] SERIES, 1 BULB,
GROMMET MOUNT, 2"X 6" OVAL**



FEATURES

- Contains a heavy-duty dual filament bulb
- Mounts horizontally or vertically

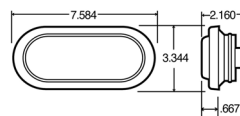

Part Number	Lamp Connector	Plug Side 1	Plug Side 2	Lens Material	Mount Color	Volts	Amps Major/Minor	Kit Includes/ Replacement Parts
60283R	PL-3	—	—	PC		12	2.1/0.48	—
60083R	PL-3	PL-3	Stripped End/ Ring Terminal	PC	Black	12	2.1/0.48	60283R lamp, 94993 plug, 60700 grommet



**60[®] SERIES, SEALED,
GROMMET MOUNT, 2"X 6" OVAL**



FEATURES

- Mounts horizontally or vertically
- Right angle plug assembly

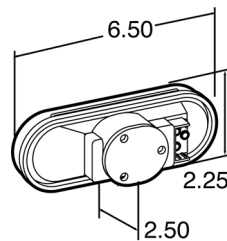

Part Number	Lamp Connector	Plug Side 1	Plug Side 2	Lens Material	Mount Color	Volts	Amps Major/Minor	Kit Includes/ Replacement Parts
60202R	PL-3	—	—	PC	Black	12	2.1/0.48	—
60002R	PL-3	PL-3	Stripped End/ Ring Terminal	PC	Black	12	2.1/0.48	60202R lens, 60700 grommet, 94993 plug
60207R	PL-3	—	—	PC	Black	24	0.93/0.34	—
60007R	PL-3	PL-3	Stripped End/ Ring Terminal	PC	Black	24	0.93/0.34	60207R lens, 60083R grommet, 94993 plug



**LED, HARDWIRED,
3"X 4", RECTANGULAR, 4 SCREW, 1 DIODE**



FEATURES

- Ideal for light duty trailers, golf carts, industrial vehicles
- Polycarbonate lens with pillow optics
- Stamped steel back plate
- Uses bulb #2057

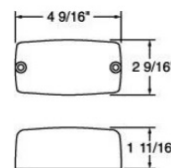

Part Number	Lamp Connector	Plug Side 1	Plug Side 2	Lens Material	Mount Color	Volts	Amps Major/Minor
548	Hardwired	Hardwired	Stripped End	PC	Black	12	2.1/0.48

INCANDESCENT

60 ECONOMY

INCANDESCENT

SUPER 60

LED

SIGNAL-STAT

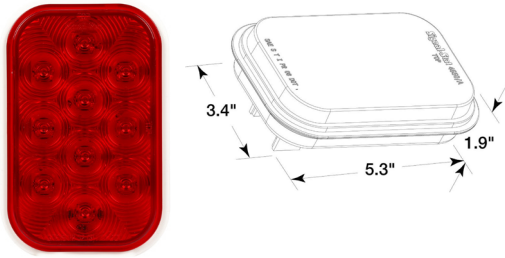

MODEL 45, GROMMET MOUNT, 3"X 5", LED, 10 DIODES

FEATURES

- Uses standard right angle PL-3 connection
- Unique LED array displays full pattern light output Epoxy encapsulated electronics



Part Number	Lamp Connector	Lens Material	Volts	Amps Major/Minor
4558	PL-3	AC	12	0.28 / 0.03

LED
SIGNAL-STAT



45[®] SERIES, HARDWIRED, GROMMET MOUNT, 3"X 5", LED, 15 DIODES

FEATURES

- Mount horizontally or vertically
- Specifically designed for use in trailer & body applications



Part Number	Lamp Connector	Plug Side 1	Plug Side 2	Lens Material	Mount Color	Volts	Amps Major/Minor	Kit Includes/ Replacement Parts
45258R	Hardwired	—	—	AC	—	12 24	0.25 / 0.01	—
45058R	Hardwired	Hardwired	Straight Female PL-3	AC	Black	12 24	0.25/0.01	45258 lamp, 45700 grommet

LED
45 SERIES



45[®] SERIES, GROMMET MOUNT, 3"X 5", LED, 15 DIODES

FEATURES

- Complies with FMVSS 108 mounted vertically or horizontally
- Specifically designed for use in trailer and body applications
- Epoxy-sealed electronics resist corrosion, moisture, shock and vibration
- Lamp uses integral plug



Part Number	Lamp Connector	Lens Material	Volts	Amps Major/Minor	Diamond Shell
45278R	Fit N' Forget	AC	10-30	0.335 / 0.03	Yes

LED
SIGNAL-STAT

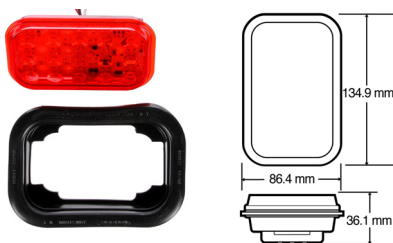

45[®] SERIES, GROMMET MOUNT, 3"X 5", LED, 15 DIODES, ECE

FEATURES

- Direct pin-to-circuit board solders assure vibration resistant contacts
- Electronics completely sealed in epoxy to resist corrosion & moisture



Part Number	Lamp Connector	Plug Side 1	Plug Side 2	Lens Material	Mount Color	Volts	Amps Major/Minor	Kit Includes/ Replacement Parts
45932R	Hardwired	—	—	PC	—	12 24	0.18 / 0.04	—
45042R	Hardwired	Hardwired	.180 Bullet	PC	Black	12 24	0.18 / 0.04	45932R lamp, 45700 grommet

LED
45 SERIES

LED

45 SERIES

45® SERIES, HARDWIRED, FLANGE MOUNT, 3"X 5", LED, 15 DIODES,



FEATURES

- Mount horizontally or vertically
- Specifically designed for use in trailer & body applications

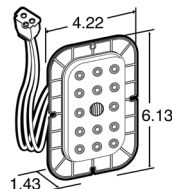

Part Number	Lamp Connector	Plug Side 1	Plug Side 2	Lens Material	Mount Color	Volts	Amps Major/Minor
45259R	Hardwired	Hardwired	Straight Female PL-3	AC	Gray	12 24	0.30 / 0.038

LED

45 SERIES

45® SERIES, FLANGE MOUNT, 3"X 5", LED, 15 DIODES



FEATURES

- Complies with FMVSS 108 mounted vertically or horizontally
- Specifically designed for use in trailer and body applications
- Epoxy-sealed electronics resist corrosion, moisture, shock and vibration

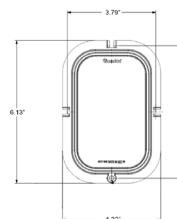

Part Number	Lamp Connector	Lens Material	Volts	Amps Major/Minor	Diamond Shell
45279R	Fit N' Forget	AC	10-30	0.30 / 0.038	Yes

LED

SIGNAL-STAT

SIGNAL-STAT, LED, 24 DIODES, 3"X 5", GROMMET MOUNT



FEATURES

- 24 diode pattern
- Unique LED array displays full pattern light output
- Uses standard right angle PL-3 connection

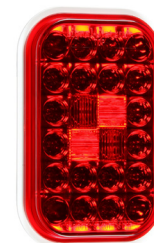
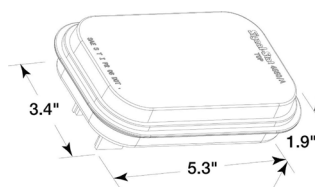

Part Number	Lamp Connector	Lens Material	Volts	Amps Major/Minor
4550	PL-3	AC	12	0.13 / 0.025

INCANDESCENT

41 SERIES

41 SERIES, SEALED, 3"X 5", FLANGE MOUNT



FEATURES

- Mounts in 7.83" x 4.43" hole
- Requires separate reflector to meet legal requirements

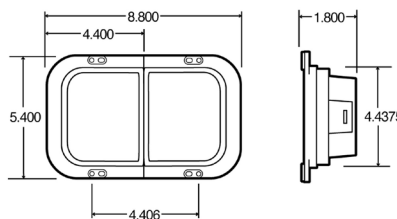

Part Number	Position	Lamp Connector	Plug Side 1	Plug Side 2	Lens Material	Mount Color	Volts	Amps Maj/Min	Kit Includes/ Replacement Parts
41202R	LH	PL-3	—	—	PC	White	12	2.1/0.48	—
41203R	RH	PL-3	—	—	PC	White	12	2.1/0.48	—
41005R	LH	PL-3	Straight PL-3	Ring Terminal/Molded Four-Position .180	PC	White	12	2.1/0.48	41202R lamp, 41203R lamp, 94948 plug (KIT)
41006R	RH	PL-3	Straight PL-3	Ring Terminal/Molded Four-Position .180	PC	White	12	2.1/0.48	41202R lamp, 41203R lamp, 94949 plug (KIT)
41007R	Universal	PL-3	Straight PL-3	Stripped End/ Ring Terminal	PC	White	12	2.1/0.48	41202R lamp, 41203R lamp, 94926 plug(x2) (KIT)
41008R	Universal	PL-3	Straight PL-3	Ring Terminal/ 2-Position Plug	PC	White	12	2.1/0.48	41202R, 41203R lamp (KIT)

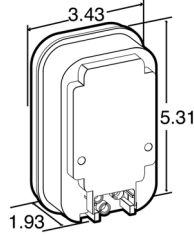

**SUPER 45[®], SEALED,
3"X 5", GROMMET MOUNT**

FEATURES

- Heavy-duty dual filament cartridge bulb
- Mount horizontally or vertically
- Unique shock mount absorbs shock & vibration



Part Number	Lamp Connector	Plug Side 1	Plug Side 2	Lens Material	Mount Color	Volts	Amps Major/Minor	Kit Includes/ Replacement Parts
45202R	PL-3	—	—	PC	Black	12	2.1/0.48	—
45002R	PL-3	Hardwired	Stripped End/ Ring Terminal	PC	Black	12	2.1/0.48	45202R lamp, 94993 plug, 45700 grommet

INCANDESCENT

SUPER 45

KIT

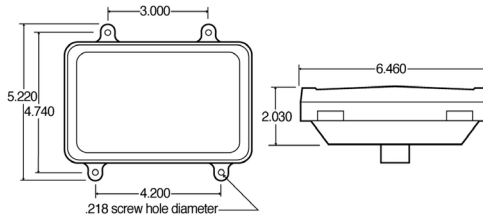

**SEALED, 4 SCREW,
4"X 6", SOCKET ASSEMBLY**

FEATURES

- Recess mounts using two screws at 3.0" centers and two screws at 4.2" centers



Part Number	Lamp Connector	Lens Material
07098	Socket Assembly	PC

INCANDESCENT

4 SCREW

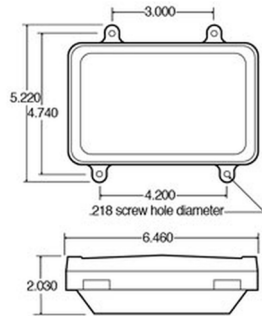

**SEALED, 4 SCREW,
4"X 6", 4 SCREW,**

FEATURES

- Recess mounts using two screws at 3.0" centers and two screws at 4.2" centers
- Watertight lamp mates with Packard connector
- 12v lamps mate with P.E. Connector 6288471



Part Number	Lamp Connector	Lens Material	Volts	Amps Major/Minor
07081	Blade Terminal	PC	12	2.1/0.48
07092	Blade Terminal	PC	12	2.1/0.48
07093	Blade Terminal	PC	24	3.1/1.48

INCANDESCENT

4 SCREW

LED
SUPER 44

SUPER 44[®], S/T/T+BACK-UP COMBO, GROMMET MOUNT.
GROMMET MOUNT, 4" ROUND, LED | HARDWIRED



FEATURES

- 8 Diodes
- Offers the same safety and low-maintenance benefits of existing LED S/T/T and BU lights now in one package
- Complies with FMVSS requirement for minimum of 75 cm2 of luminous red area
- Saves space in inventory when stocking a two-in-one product
- New combination lamps are the same size as existing Truck-Lite Model 44 lights, so they fit into existing mounting holes
- Lower-cost system when replacing other hardwired 44 products

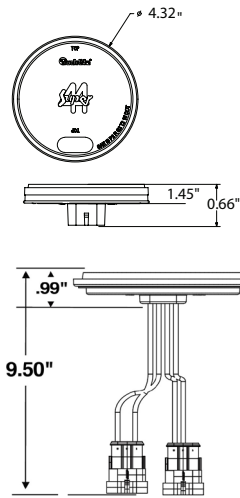

44557R - NON-Hardwired



44556R - HARDWIRED

Part Number	Lamp Connector	Plug Side 1	Plug Side 2	Lens Material	Lens Color	Volts	Amps Major/Minor
44557R	Fit N' Forget 4-Pin	-	-	PC	Red Clear	12	Tail: 0.025 Stop: 0.205 B/U: 0.370
44556R	Hardwired	Hardwired	Fit 'N Forget S.S.	PC	Red Clear	12	Tail: 0.025 Stop: 0.205 B/U: 0.370

LED
SUPER 44

SUPER 44[®], S/T/T+BACK-UP, HEATED, GROMMET MOUNT, 4" ROUND, LED

HEAT[®]D



FEATURES

- 8 Diodes
- The new heated LED stop/turn/tail lamp offers signature Truck-Lite styling
- Rugged construction
- Heating element that consistently warms the lamp as temperatures fall, preventing ice and snow buildup in even the most severe winter weather.

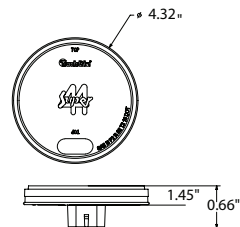

Part Number	Lamp Connector	Plug Side 1	Plug Side 2	Lens Material	Lens Color	Volts	Amps Major/Minor
44605R	4-pin Amp	4-pin Amp	Integral Plug	PC	Red	12.8	Tail: 1.025 Stop: 1.150 B/U: 0.370

LED
SUPER 44

SUPER 44[®], S/T/T+BACK-UP, SURFACE MOUNT, 4" ROUND, LED



FEATURES

- 8 Diodes
- Offers the same safety and low-maintenance benefits of existing LED S/T/T and BU lights now in one package
- Complies with FMVSS requirement for minimum of 75 cm2 of luminous red area
- Saves space in inventory when stocking a two-in-one product
- New combination lamps are the same size as existing Truck-Lite Model 44 lights, so they fit into existing mounting holes
- Lower-cost system when replacing other hardwired 44 products

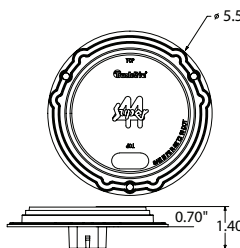

Part Number	Lamp Connector	Plug Side 1	Plug Side 2	Lens Material	Lens Color	Mount Color	Volts	Amps Major/Minor
44555R	Fit N' Forget 4-Pin	-	-	PC	Red Clear	Grey	12	Tail: 0.025 Stop: 0.205 B/U: 0.370

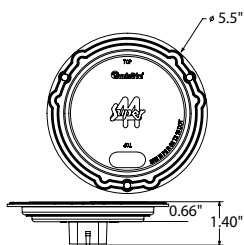

**SUPER 44[®], S/T/T+BACK-UP,
LED, FLANGE MOUNT, 4" ROUND,**

FEATURES

- 8 Diodes
- Offers the same safety and low-maintenance benefits of existing LED S/T/T and BU lights now in one package
- Complies with FMVSS requirement for minimum of 75 cm2 of luminous red area
- Saves space in inventory when stocking a two-in-one product
- New combination lamps are the same size as existing Truck-Lite Model 44 lights, so they fit into existing mounting holes
- Lower-cost system when replacing other hardwired 44 products



Part Number	Lamp Connector	Mount Color	Lens Material	Lens Color	Volts	Amps Major/Minor
44552R	Fit 'N Forget 4 Pin S.S.	Black	PC	Red Clear	12	Tail: 0.025 Stop: 0.205 B/U: 0.370
44553R	Fit 'N Forget 4 Pin S.S.	Grey	PC	Red Clear	12	Tail: 0.025 Stop: 0.205 B/U: 0.370
44554R	Fit 'N Forget 4 Pin S.S.	White	PC	Red Clear	12	Tail: 0.025 Stop: 0.205 B/U: 0.370

LED

SUPER 44

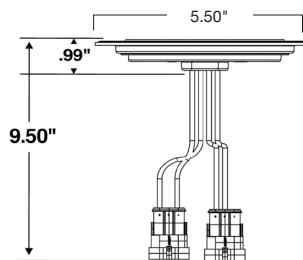

**SUPER 44[®], S/T/T+BACK-UP,
HARDWIRED,
FLANGE MOUNT, 4" ROUND**

FEATURES

- 8 Diodes
- Offers the same safety and low-maintenance benefits of existing LED S/T/T and BU lights now in one package
- Complies with FMVSS requirement for minimum of 75 cm2 of luminous red area
- Saves space in inventory when stocking a two-in-one product
- New combination lamps are the same size as existing Truck-Lite Model 44 lights, so they fit into existing mounting holes
- Lower-cost system when replacing other hardwired 44 products



Part Number	Lamp Connector	Plug Side 1	Plug Side 2	Lens Material	Lens Color	Mount Color	Volts	Amps Major/Minor
44550R	Hardwired	Hardwired	Fit 'N Forget S.S.	PC	Red Clear	Black	12	Tail: 0.025 Stop: 0.205 B/U: 0.370
44551R	Hardwired	Hardwired	Fit 'N Forget S.S.	PC	Red Clear	Grey	12	Tail: 0.025 Stop: 0.205 B/U: 0.370

LED

SUPER 44

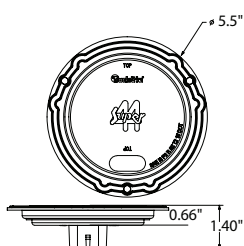

**SUPER 44[®], S/T/T+BACK-UP,
HEATED, FLANGE MOUNT
LED, 4" ROUND**

FEATURES

- 8 Diodes
- The new heated LED stop/turn/tail lamp offers signature Truck-Lite styling
- Rugged construction
- Heating element that consistently warms the lamp as temperatures fall, preventing ice and snow buildup in even the most severe winter weather.

HEATED



Part Number	Lamp Connector	Plug Side 1	Plug Side 2	Lens Material	Lens Color	Mount Color	Volts	Amps Major/Minor
44625R	4-pin Amp	4-pin Amp	Integral Plug	PC	Red	Grey	12.8	Tail: 1.025 Stop: 1.150 B/U: 0.370
44610R	3-pin Amp	3-pin Amp	Integral Plug	PC	Red	Grey	12.8	Tail: 1.025 Stop: 1.150 B/U: 0.370

LED

SUPER 44

**60[®] SERIES, S/T/T + BACK-UP,
LED, GROMMET MOUNT, 2"X 6" OVAL |
HARDWIRED**



FEATURES

- 8 Diodes
- Offers the same safety and low maintenance benefits of existing LED S/T/T and BU lights now in one package
- Not orientation dependent; complies with FMVSS 108 vertically or horizontally
- Save space in inventory
- Lower-cost system
- The new combination lamps are the same size as existing Truck-Lite Model 60 lights, which means they fit into existing mounting holes

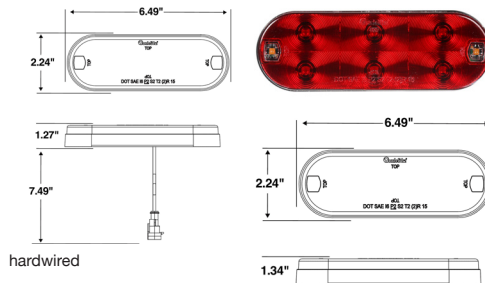

Part Number	Lamp Connector	Plug Side 1	Plug Side 2	Lens Material	Lens Color	Volts	Amps Major/Minor
60556R	Hardwired	Hardwired	Fit 'N Forget S.S.	PC	Red Clear	13.5	Stop 0.21A Tail 0.020A Backup 0.275A
60557R	Fit 'N Forget 4 Pin S.S.	-	-	PC	Red Clear	13.5	Stop 0.21A Tail 0.020A Backup 0.275A

**60[®] SERIES, S/T/T + BACK-UP,
FLANGE MOUNT, LED, 2"X 6" OVAL,
HARDWIRED**



FEATURES

- 8 Diodes
- Offers the same safety and low maintenance benefits of existing LED S/T/T and BU lights now in one package
- Not orientation dependent; complies with FMVSS 108 vertically or horizontally
- Save space in inventory
- Lower-cost system
- The new combination lamps are the same size as existing Truck-Lite Model 60 lights, which means they fit into existing mounting holes



Part Number	Lamp Connector	Plug Side 1	Plug Side 2	Lens Material	Lens Color	Volts	Amps Major/Minor
60559R	Hardwired	Hardwired	Fit 'N Forget S.S.	PC	Red Clear	13.5	Stop 0.21A Tail 0.020A Backup 0.275A

**60[®] SERIES, S/T/T+BACK-UP, HEATED,
LED, GROMMET MOUNT, 4" ROUND, HARDWIRED**

HEATED



FEATURES

- 8 Diodes
- The new heated LED stop/turn/tail lamp offers signature Truck-Lite styling
- Rugged construction
- Heating element that consistently warms the lamp as temperatures fall, preventing ice and snow buildup in even the most severe winter weather.

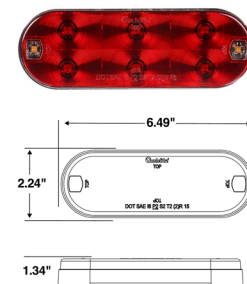

Part Number	Lamp Connector	Plug Side 1	Plug Side 2	Lens Material	Lens Color	Mount Color	Volts	Amps Major/Minor
60610R	4-pin Amp	4-pin Amp	Hardwired	PC	Red	Black	13.5	Tail: 1.020 Stop: 1.205 B/u: 0.275

LED

60 SERIES

LED

60 SERIES

LED

60 SERIES

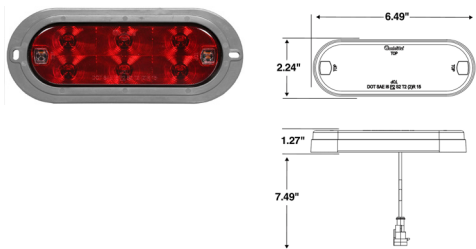

60[®] SERIES, S/T/T+BACK-UP, HEATED, LED, FLANGE MOUNT, 2\"/>

FEATURES



- 8 Diodes
- The new heated LED stop/turn/tail lamp offers signature Truck-Lite styling
- Rugged construction
- Heating element that consistently warms the lamp as temperatures fall, preventing ice and snow buildup in even the most severe winter weather.

Part Number	Lamp Connector	Plug Side 1	Plug Side 2	Lens Material	Lens Color	Mount Color	Volts	Amps Major/Minor
60630R	4-pin Amp	4-pin Amp	Hardwired	PC	Red		13.5	Tail: 1.020 Stop: 1.205 B/u: 0.275

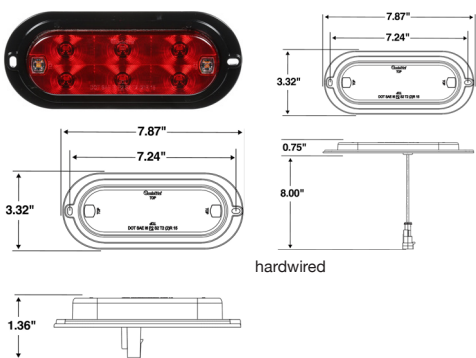

60[®] SERIES, S/T/T + BACK-UP, LED, SURFACE MOUNT, 2\"/>

FEATURES



- 8 Diodes
- Offers the same safety and low maintenance benefits of existing LED S/T/T and BU lights now in one package
- Not orientation dependent; complies with FMVSS 108 vertically or horizontally
- Save space in inventory
- Lower-cost system
- The new combination lamps are the same size as existing Truck-Lite Model 60 lights, which means they fit into existing mounting holes

Part Number	Lamp Connector	Plug Side 1	Plug Side 2	Lens Material	Lens Color	Mount Color	Volts	Amps Major/Minor
60554R	Hardwired	Hardwired	Fit 'N Forget S.S.	PC	Red Clear	Black	13.5	Stop 0.21A, Tail 0.020A, Backup 0.275A
60555R	Fit 'N Forget 4 Pin S.S.	—	—	PC	Red Clear	Black	13.5	Stop 0.21A, Tail 0.020A, Backup 0.275A

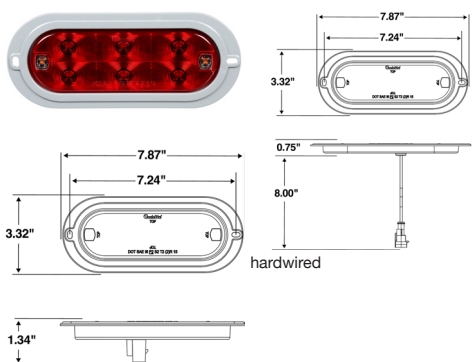

60[®] SERIES, S/T/T + BACK-UP, LED, FLUSH MOUNT, 2\"/>

FEATURES



- 8 Diodes
- Offers the same safety and low maintenance benefits of existing LED S/T/T and BU lights now in one package
- Not orientation dependent; complies with FMVSS 108 vertically or horizontally
- Save space in inventory
- Lower-cost system
- The new combination lamps are the same size as existing Truck-Lite Model 60 lights, which means they fit into existing mounting holes

Part Number	Lamp Connector	Plug Side 1	Plug Side 2	Lens Material	Lens Color	Mount Color	Volts	Amps Major/Minor
60550R	Hardwired	Hardwired	.180 Bullet	PC	Red Clear	Black	13.5	Stop 0.21A, Tail 0.020A, Backup 0.275A
60551R	Hardwired	Hardwired	Fit 'N Forget S.S.	PC	Red Clear	Gray	13.5	Stop 0.21A, Tail 0.020A, Backup 0.275A
60552R	Fit 'N Forget 4 Pin S.S.	—	—	PC	Red Clear	Black	13.5	Stop 0.21A, Tail 0.020A, Backup 0.275A
60553R	Fit 'N Forget 4 Pin S.S.	—	—	PC	Red Clear	Gray	13.5	Stop 0.21A, Tail 0.020A, Backup 0.275A

INCANDESCENT

**40[®] SERIES, CHMSL
GROMMET MOUNT, 4"**



FEATURES

- Features high-mount stop function when center mounted on the top rear of the vehicle
- Heavy-duty, shock-mounted bulb
- Recommended for use in center high mount stop lamp applications only

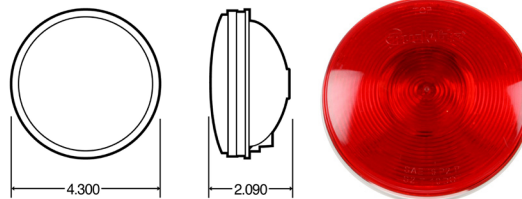

Part Number	Lamp Connector	Lens Color	Lens Material	Mount Color	Volts	Amps Major/Minor
40247R	PL-3	Red	PC		12	1.44

40 SERIES

LED

**60[®] SERIES, CHMSL,
GROMMET MOUNT, 2"X6",
LED, 26 DIODES**



FEATURES

- Recommended for auxiliary brake light applications only
- Electronics completely sealed in epoxy to resist corrosion and moisture

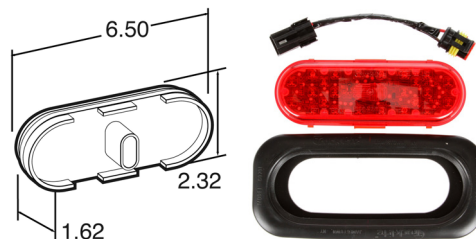

Part Number	Lamp Connector	Plug Side 1	Plug Side 2	Lens Color	Lens Material	Mount Color	Volts	Amps Major/Minor	Kit Includes/ Replacement Parts
60260R	Fit 'N Forget S.S.	-	-	Red	PC	-	12	0.342/0.054	-
60061R	Fit 'N Forget S.S.	Fit 'N Forget S.S.	Straight PL-2	Red	PC	Black	12	0.21/0.04	60260R lens, 60700 grommet, 94789 plug (KIT)

60 SERIES

LED

**60[®] SERIES, FLANGE MOUNT,
2"X6", LED, 26 DIODES**



FEATURES

- Recommended for auxiliary brake light applications only
- Electronics completely sealed in epoxy to resist corrosion and moisture



Part Number	Lamp Connector	Plug Side 1	Plug Side 2	Lens Color	Lens Material	Mount Color	Volts	Amps Major/Minor	Kit Includes/ Replacement Parts
60262R	Fit 'N Forget S.S.	-	-	Red	PC	Gray	12	0.342/0.054	-
60062R	Fit 'N Forget S.S.	Fit 'N Forget S.S.	Straight PL-2	Red	PC	Gray	12	0.342/0.054	60262R lens, 94789 plug (KIT)
60266R	Fit 'N Forget S.S.	-	-	Red	PC	Black	12	0.342/0.054	-

60 SERIES

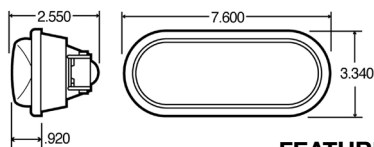

SUPER 60[®], GROMMET MOUNT



FEATURES

- Features high-mount stop function when center mounted on the top rear of the vehicle
- Heavy-duty shock-mounted bulb
- Recommended for auxiliary brake light applications only
- Upgrade to Truck-Lite LED Systems using part #60061R or 60260R

Part Number	Lamp Connector	Plug Side 1	Plug Side 2	Lens Color	Lens Material	Mount Color	Volts	Amps Major/Minor	Kit Includes
60213R	PL-2	-	-	Red	PC	-	12	1.44	-
60013R	PL-2	Right Angle PL-2	Stripped End/Ring Terminal	Red	PC	Black	12	1.44	60213R lens, 60700 grommet, 94992 plug

KIT

INCANDESCENT

SUPER 60

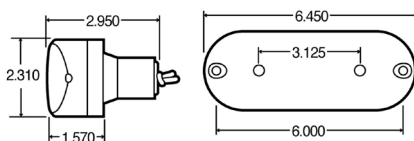

60[®] SERIES, CHMSL, 2\"/>



FEATURES

- Features high-mount stop function when center mounted on the top rear of the vehicle
- Single filament bayonet-base bulb
- Uses standard mounting holes & accessories
- Welded lamp grommet mounts
- Uses bulb #1141

Part Number	Lamp Connector	Plug Side 1	Plug Side 2	Lens Color	Lens Material	Mount Color	Volts	Amps Major/Minor	Kit Includes
60303R	Hardwired	Hardwired	Stripped End/Ring Terminal	Red	PC	12	1.44	-	99011R lens, 60789 housing

KIT

INCANDESCENT

60 SERIES

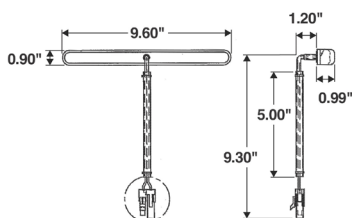

LED, 1\"/>



FEATURES

- Slim lamp welcomes applications where space is at a premium
- Adhesive back adheres to mounting surface without the need for installation screws or brackets
- Peel-and-stick design makes for a tight, unbreakable seal
- DOT/SAE compliant
- 9.6" wire lead makes wiring easier
- Recommended for use in center high-mounted stop lamp applications only

Part Number	Lamp Connector	Plug Side 1	Plug Side 2	Lens Color	Lens Material	Volts	Amps Major/Minor
92101	Hardwired	Hardwired	Packard Connector	Red	PC	12	0.23
92100	Hardwired	Hardwired	Stripped End	Red	PC	12	0.23

LED

1 IN X 9 IN

LED

21 SERIES

**21[®] SERIES, HARDWIRED,
2"X6", BRACKET MOUNT, LED, 16 DIODES**



FEATURES

- Optional gaskets available to improve seal between lamp and body
- Electronics completely sealed in epoxy to resist corrosion and moisture
- Hardwired design eliminates pin corrosion
- Recommended for use in center high mounted stop lamp applications only

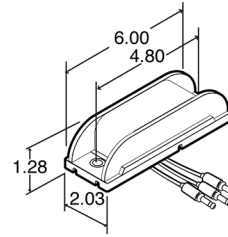

Part Number	Lamp Connector	Plug Side 1	Plug Side 2	Lens Color	Lens Material	Volts	Amps Major/Minor
21271R	Hardwired	Hardwired	.180 Bullet	Red	PC	12	0.225/0.054

INCANDESCENT

45 SERIES

**45[®] SERIES, GROMMET MOUNT,
3"X5", INCANDESCENT**



FEATURES

- Features high mount stop function when center mounted on the top rear of the vehicle
- Heavy-duty, shock-mounted bulb
- Recommended for use in center high-mounted stop lamp applications

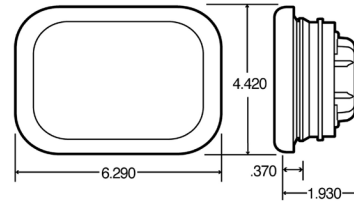

Part Number	Lamp Connector	Plug Side 1	Plug Side 2	Lens Color	Lens Material	Mount Color	Volts	Amps Major/Minor	Kit Includes/ Replacement Parts
45207R	PL-3	-	-	Red	PC	Black	12	1.44	-
45007R	PL-2	PL-2	Stripped End/Ring Terminal	Red	PC	Black	12	1.44	45207R lens, 45700 grommet, 94992 plug

(KIT)

Not seeing the products you're looking for?

Visit truck-lite.com



Powerful Search Function



360° Product Images



Easy-To-Find Replacement Parts



5015K

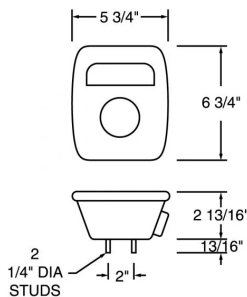

MULTI-FUNCTION, INCANDESCENT, MACK, 2 STUD MOUNT

FEATURES

- Mack #14M052M, 14MO52AM
- Used on tractors, trucks and 4 wheel drive vehicles
- 5015 Left Hand Plug Inboard
- 5016 Right Hand Plug Inboard
- Conforms to current DOT and SAE Standards
- Replacement lens # 9072



Part Number	License Lamp	Lamp Connection	Plug Side 1	Plug Side 2	Lens Material	Volts	Amps Major/Minor
5015	Yes	Packard Connector	No Plug	No Plug	AC	12	2.1/0.59
5015K	Yes	Packard Connector	Packard Connector	Blunt Cut Ring Terminal	AC	12	2.1/0.59
5016	No	Packard Connector	No Plug	No Plug	AC	12	2.1/0.59
5016K	No	Packard Connector	Packard Connector	Blunt Cut Ring Terminal	AC	12	2.1/0.59

INCANDESCENT

MACK

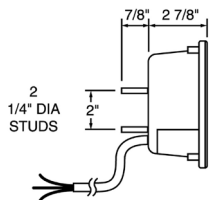

MULTI-FUNCTION, INCANDESCENT, FORD/DODGE, 2 STUD MOUNT

FEATURES

- Dodge Truck #3895020 and 3895021
- Ford #DOTZ13404A, D3KZ13404A, D3TZ13403B, E2TB13404A and E2TB13405A
- Combination stop, tail, turn, back-up lamp with reflex reflector replaces Dodge and Ford truck models
- Universal rear pigtail connection
- Dual-optic lens and housing molded from tough polycarbonate with high heat and impact resistance
- Replacement lens 9049 and gasket 97706



Part Number	Position	License Lamp	Lamp Connection	Plug Side 1	Plug Side 2	Lens Material	Volts	Amps Major/Minor
4028		Yes	Hardwired	Hardwired	Stripped End	PC	12	2.1/0.59

INCANDESCENT

FORD/DODGE

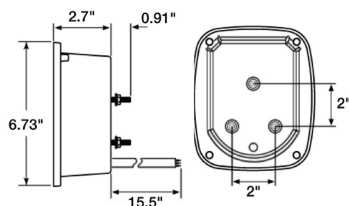

MULTI-FUNCTION, LED, 3 STUD MOUNT

FEATURES

- Kit provides all legal lamps & reflective products for trailers less than 80" wide



Part Number	Position	License Lamp	Lamp Connection	Plug Side 1	Plug Side 2	Lens Material	Volts	Amps Major/Minor
5070	LH	Yes	Hardwired	Hardwired	Stripped End	AC	12	0.90/0.070
5071	RH	No	Hardwired	Hardwired	Stripped End	AC	12	0.90/0.070
5072	LH	Yes	Hardwired	Hardwired	Packard Connector/ Ring Terminal	AC	12	0.90/0.070
5073	RH	No	Hardwired	Hardwired	Packard Connector/ Ring Terminal	AC	12	0.90/0.070

LED

SIGNAL-STAT

INCANDESCENT

3 STUD MOUNT

SIGNAL-STAT, INCANDESCENT, RECTANGULAR, 3 STUD MOUNT



FEATURES

- Replaces all GM medium and heavy-duty 1972 to 1985
- Integral housing with 3 bolt mount
- Includes junction box cover
- Plugs are inboard
- Replacement lens 9071 and gasket 97706

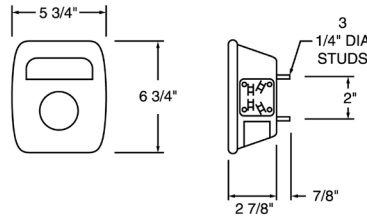

Part Number	Position	License Lamp	Lamp Connection	Lens Material	Volts	Amps Major/Minor
4017	LH	No	Screw Terminal	PC	12	2.1/0.59
4018	RH	Yes	Screw Terminal	PC	12	2.1/0.59

INCANDESCENT

3 STUD MOUNT

SIGNAL-STAT, INCANDESCENT, RECTANGULAR, 3 STUD MOUNT, HARDWIRED



FEATURES

- Combination stop/turn/tail, back-up and reflex reflector
- Three bolt on 2" triangle
- Upgrade to LED Truck-Lite LED Products using #5070-#5073
- Replacement lens 9049 and gasket 97706

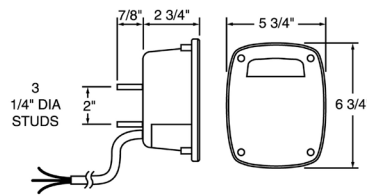

Part Number	Packaging Type	License Lamp	Lamp Connection	Plug Side 1	Plug Side 2	Lens Material	Volts	Amps Major/Minor
4027	Standard	No	Hardwired	Hardwired	Stripped End	AC	12	2.1/0.59
4027D	Display	No	Hardwired	Hardwired	Stripped End	AC	12	2.1/0.59

INCANDESCENT

FORD

SIGNAL-STAT, INCANDESCENT, RECTANGULAR, 3 STUD MOUNT, FORD



FEATURES

- Ford #D9HZ13405A and B (curbside)
- Ford #D9HZ13404A and B (roadside)
- Fits 1979 and later Ford models
- Includes junction box cover
- Rear lamp assembly combining stop, tail, turn, back-up and reflex reflector
- Plugs are inboard
- Replacement lens 9071 and gasket 97706

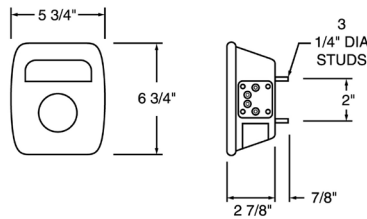

Part Number	Position	License Lamp	Lamp Connection	Lens Material	Volts	Amps Major/Minor
4023	RH	Yes	Stud Terminal	PC	12	2.1/0.59
4024	LH	Yes	Stud Terminal	PC	12	2.1/0.59

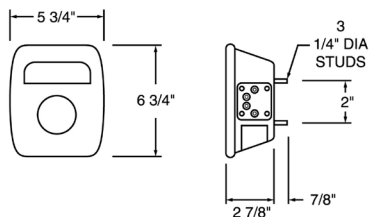

SIGNAL-STAT, INCANDESCENT, RECTANGULAR, 3 STUD MOUNT, FREIGHTLINER

FEATURES

- Freightliner #A06-13581-001 (curbside)
- Freightliner #A06-13581-000 (roadside)
- Includes junction box cover
- Rear lamp assembly combining stop, tail, turn, back-up and reflex reflector
- Plugs are inboard
- Replacement lens 9072



Part Number	Position	License Lamp	Lamp Connection	Lens Material	Volts	Amps Major/Minor
4023Y106	RH	Yes	Stud Terminal	Acrylic	12	2.1/0.59
4024Y106	LH	Yes	Stud Terminal	Acrylic	12	2.1/0.59

INCANDESCENT

FORD

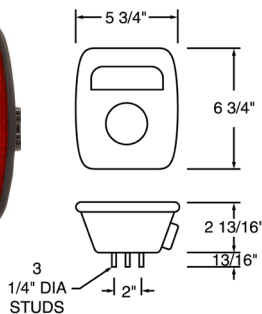

SIGNAL-STAT, INCANDESCENT, RECTANGULAR, 3 STUD MOUNT, FREIGHTLINER/PETERBILT/GM

FEATURES

- Freightliner #681-544-0503 Peterbilt #16-06291 Volvo GM #8067855
- Plugs are inboard



Part Number	Position	License Lamp	Lamp Connection	Lens Material	Volts	Amps Major/Minor
5023	LH	Yes	Packard Connector 12020116/ Packard Connector 12066271	PC	12	2.1/0.59
5024	RH	Yes	Packard Connector 12066271/ Packard Connector 12020116	PC	12	2.1/0.59

FREIGHTLINER / PETERBILT / GM

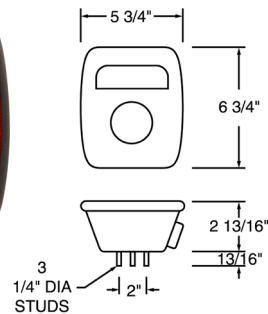

SIGNAL-STAT, INCANDESCENT, RECTANGULAR, 3 STUD MOUNT, FREIGHTLINER/PETERBILT/OSHKOSH

FEATURES

- 5013, 5013K: GM #15565731, 15574697, 15613943, 15684994 Oshkosh #2078210 Peterbilt #16-06160L
- 5014: GM #15565732, 15574696, 15613944, 15684995 Freightliner #681-544-04-03 Oshkosh #2078200 Peterbilt #16-06160R, 16-06292
- 5023Y102: Navistar #1661281C91
- Plugs are inboard



Part Number	Position	License Lamp	Lamp Connection	Plug Side 1	Plug Side 2	Lens Material	Volts	Amps Major/Minor
5013	LH	Yes	Packard Connector 12066271	-	-	PC	12	2.1/0.59
5013K	LH	Yes	Packard Connector	Packard Connector	Stripped End	PC	12	2.1/0.59
5014	RH	No	Packard Connector	-	-	PC	12	2.1/0.59
5014K	RH	No	Packard Connector	Packard Connector	Stripped End	PC	12	2.1/0.59

FREIGHTLINER / PETERBILT / GM / OSHKOSH

INCANDESCENT
NAVISTAR

SIGNAL-STAT, INCANDESCENT, RECTANGULAR, 3 STUD MOUNT, NAVISTAR



FEATURES

- Navistar #467707C91 and 424538C91 (LH).
- Navistar #467708C91 and 424539C91 (RH).
- Includes junction box cover.
- Plugs are inboard

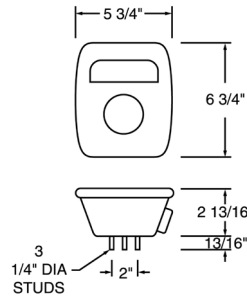

Part Number	Position	License Lamp	Lamp Connection	Lens Material	Volts	Amps Major/Minor
4015	LH	Yes	Blade Terminal	PC	12	2.1/0.59
4016	RH	Yes	Blade Terminal	PC	12	2.1/0.59

INCANDESCENT
NAVISTAR

SIGNAL-STAT, INCANDESCENT, RECTANGULAR, 3 STUD MOUNT, NAVISTAR



FEATURES

- 5023Y102: Navistar #1661281C91
- Plugs are inboard

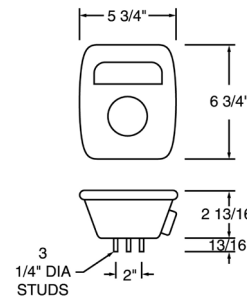

Part Number	Position	License Lamp	Lamp Connection	Lens Material	Volts	Amps Major/Minor
5014Y102	RH	No	Packard Connector 12034047	PC	12	2.1/0.59
5023Y102	LH	Yes	Packard Connector 12020116/ Packard Connector 12034047	PC	12	2.1/0.59

INCANDESCENT
NAVISTAR

SIGNAL-STAT, INCANDESCENT, RECTANGULAR, 3 STUD MOUNT, NAVISTAR



FEATURES

- Navistar #1661281C91
- Navistar #1661282C91
- RH lamp popular replacement for GM/IH OE #56139474, #15565732
- Combination stop, tail, turn, back-up and reflex reflector
- Dual-optic acrylic lens
- Permastat body provides impact resistance
- 5315Y101 has dual Metri-Pack connectors-one on either side of the lamp
- 5315Y101 uses #9470 main harness
- 5316Y101 uses #9469 jumper harness
- Plugs are inboard
- Replacement lens 9049 and gasket 97706

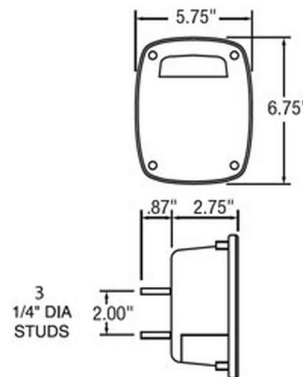

Part Number	Position	License Lamp	Lamp Connection	Lens Material	Volts	Amps Major/Minor
5315Y101	LH	Yes	Packard Connector	PC	12	2.1/0.59
5316Y101	RH	Yes	Packard Connector	PC	12	2.1/0.59

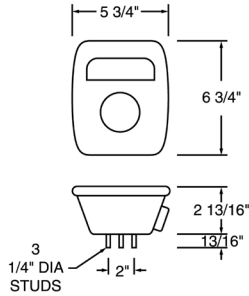

SIGNAL-STAT, INCANDESCENT, RECTANGULAR, 3 STUD MOUNT, VOLVO

FEATURES

- 5014Y101: Volvo GM #8067856
- Plugs are inboard



Part Number	Position	License Lamp	Lamp Connection	Lens Material	Volts	Amps Major/Minor
5014Y101	Volvo	No	Packard Connector 12066271	PC	12	2.1/0.59

INCANDESCENT

VOLVO

EVERYTHING YOU EXPECT AND MORE.

Truck-Lite's multi-purpose maintenance spray – it's safe to use on or around electronics, plastics, rubber and silicone.

You can find our maintenance spray on page 450.



SIGNAL LIGHTING

TURN SIGNAL LIGHTS

Pages 50-64

Shape	Common Size	Page
ROUND		50-54
	4"	50-52
	6"	53
	7"	53
	2"	54
SQUARE		54
	7 x 7"	54
RECTANGULAR		55-59
	2 x 6"	55
	3 x 5"	55-58
	4 x 6"	58
	7 x 13"	59
OVAL		59-64
	2 x 6"	59-64

FRONT / PARK / TURN

Pages 65-74

Shape	Common Size	Page
ROUND		65-70
	4"	65-70
	7"	70
OVAL		71-74
	2 x 6"	71-74
RECTANGULAR		74
	3 x 5"	74
	4 x 6"	74

LONG LIFE VEHICLE LIGHTING (LLV)

Page 75

Shape	Common Size	Page
OVAL		75
	2 x 6"	75
RECTANGULAR		75
	3 x 5"	75

PEDESTAL LIGHTS

Pages 76-87

Common Size	Page
Single Face - Round	76-78
Single Face - Square	78

Common Size	Page
Dual Face - Round	79-82
Dual Face - Square	82-85
Dual Face - Rectangular	86-87





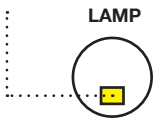
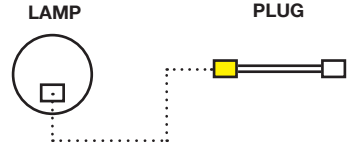
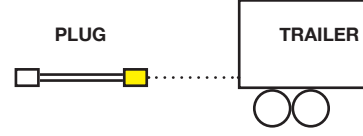

Signal Lighting

Truck-Lite’s LED turn signal lighting is designed to exceed legal requirements and increase conspicuity when correctly mounted. With faster illumination time, other drivers on the road are able to react more quickly.

<p>Shapes</p>	<p>Round, Oval, Rectangular</p>
<p>Mount Types</p>	<p>Grommet, Flange, Bracket, 2 Screw, 4 Screw, Adhesive, 2 Bolt, 1 Stud, 2 Stud</p>
<p>Connection Information</p> <p>When it comes to choosing the correct lamps for your truck or trailer, it’s important to know the connection type on your vehicle’s harness.</p> <p>If the harness connector type does not match your desired light (lamp connector), you will need a plug to complete the connection.</p>	<p>Lamp Connector</p> <p>The connector type located on the back of a lamp</p> 
	<p>Plug Side 1</p> <p>The connection between a plug and a lamp</p> 
	<p>Plug Side 2</p> <p>The connection between a plug and a trailer’s harness</p> 

(800) 562-5012 | truck-lite.com

 <p>Manufacturing & Quality</p>	 <p>Testing & Safety</p>
<p>Truck-Lite’s LED marker/clearance lighting is built using premium materials and backed by industry-leading warranties. Designed to last the life of your vehicle, Truck-Lite’s solid-state construction and sealed circuitry mean that you can depend on your lighting to withstand shock, vibration, moisture and debris.</p>	<p>All Truck-Lite lamps are subjected to rigorous environmental, electrical and mechanical testing before they are validated and released to the market.</p> <p>All lamps comply with FMVSS/CMVSS-108, SAE and DOT standards when properly mounted.</p>
 <p>Performance & Maintenance</p>	 <p>Customer Support</p>
<ul style="list-style-type: none"> • Lower energy consumption, allowing more power for other vehicle requirements • Impact-resistant lenses and rugged housing protect against damage from even the toughest applications • Sealed electronics resist damage caused by moisture and corrosion • Reduced lighting costs associated with physical damage and heat entrapment 	<p>Customer Service</p> <p>(800) 562-5012 customerservice@truck-lite.com</p> <p>Technical Support</p> <p>(888) 562-5012 tltech@truck-lite.com</p> <p>Signal Lighting Warranties</p> 
<p>(800) 562-5012 truck-lite.com</p>	

SUPER 44[®], REAR TURN, 4" , LED. GROMMET MOUNT, 6 DIODE



FEATURES

- Less current draw
- LEDs have no filament, therefore are impervious to shock and vibration
- Mounts only to rear of vehicle
- Designed to comply with FMVSS 108

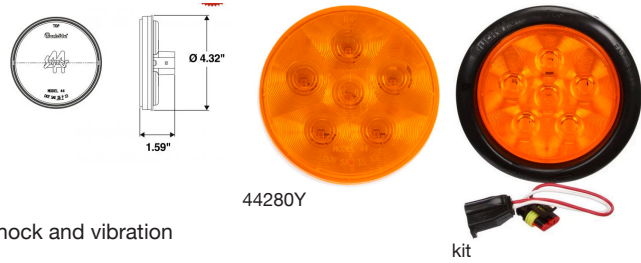

Part Number	Lamp Connector	Plug Side 1	Plug Side 2	Lens Material	Lens Color	Volts	Amps	Diamond Shell	Kit Includes/ Replacement Parts
44280Y	Fit 'N Forget S.S.	–	–	PC	Yellow	12	0.25	No	–
44281Y	Fit 'N Forget S.S.	–	–	PC	Yellow	12	0.25	Yes	–
44108Y	Fit 'N Forget S.S.	Fit 'N Forget S.S.	Straight Female PL-3	PC	Yellow	12	0.25	Yes	44281Y lamps, 40700, grommet, 94789 plug, (KIT)
44283Y	Fit 'N Forget S.S.	–	–	PC	Yellow	24	0.100	Yes	–
44113Y	Fit 'N Forget S.S.	Fit 'N Forget S.S.	Straight Female PL-3	PC	Yellow	24	0.100	Yes	44283Y lamps, 40700, grommet, 94789 plug, (KIT)

SUPER 44[®], REAR TURN, 4" , LED, FLANGE MOUNT, 6 DIODE



FEATURES

- Less current draw
- LEDs have no filament, therefore are impervious to shock and vibration
- Flange mounts are permanently affixed to lamp
- Mounts only to rear of vehicle
- Designed to comply with FMVSS 108



Part Number	Lamp Connector	Plug Side 1	Plug Side 2	Lens Material	Lens Color	Mount Color	Volts	Amps	Diamond Shell	Kit Includes
44284Y	Fit 'N Forget S.S.	–	–	PC	Yellow	White	12	0.25	No	–
44286Y	Fit 'N Forget S.S.	–	–	PC	Yellow	Black	24	0.100	No	–
44287Y	Fit 'N Forget S.S.	–	–	AC	Yellow	Grey	12	0.25	Yes	–
44290Y	Fit 'N Forget S.S.	–	–	AC	Yellow	White	12	0.25	Yes	–
44285Y	Fit 'N Forget S.S.	–	–	PC	Yellow	Grey	12	0.25	No	–
44107Y	Fit 'N Forget S.S.	Fit 'N Forget S.S.	Straight Female PL-3	PC	Yellow	Grey	12	0.25	No	44285Y lamp, 94789 plug, (KIT)
44289Y	Fit 'N Forget S.S.	–	–	PC	Yellow	Black	12	0.25	No	–
44109Y	Fit 'N Forget S.S.	Fit 'N Forget S.S.	Straight Female PL-3	PC	Yellow	Black	12	0.25	No	44289Y lamp, 94789 plug, (KIT)



**SUPER 44[®], REAR TURN,
4" ROUND, GROMMET MOUNT,
LED, 42 DIODE**

FEATURES

- Less current draw
- LEDs do not have a filament, therefore are not susceptible to damage from shock and vibration
- Designed to comply with FMVSS 108



kit

LED
SUPER 44

Part Number	Lamp Connector	Plug Side 1	Plug Side 2	Lens Material	Volts	Amps	Kit Includes/ Replacement Parts
44201Y	Fit 'N Forget S.S.	-	-	PC	12	0.500	-
44001Y	Fit 'N Forget S.S.	Fit 'N Forget S.S.	Straight Female PL-3	PC	12	0.500	44201Y lamp, 40700 grommet, 94789 plug
44273Y	Fit 'N Forget S.S.	-	-	PC	24	0.200	-
44018Y	Fit 'N Forget S.S.	Fit 'N Forget S.S.	Straight Female PL-3	PC	24	0.200	44273Y lamp, 40700 grommet, 94789 plug
44881Y	Fit 'N Forget S.S.	-	-	AC	12	0.500	-

(KIT)

(KIT)

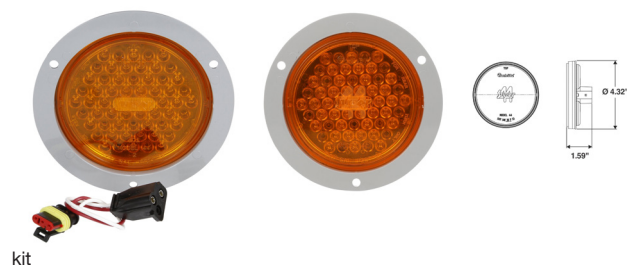

**SUPER 44[®], REAR TURN,
4" ROUND, FLANGE MOUNT,
LED, 42 DIODE**

FEATURES

- Less current draw
- LEDs do not have a filament, therefore are not susceptible to damage from shock and vibration



kit

LED
SUPER 44

Part Number	Lamp Connector	Plug Side 1	Plug Side 2	Lens Material	Mount Color	Diamond Shell	Volts	Amps	Kit Includes
44231Y	Fit 'N Forget S.S.	-	-	PC	White	No	12	0.500	-
44276Y	Fit 'N Forget S.S.	-	-	PC	Black	No	24	0.100	-
44887Y	Fit 'N Forget S.S.	-	-	AC	Gray	Yes	12	0.500	-
44888Y	Fit 'N Forget S.S.	-	-	AC	Black	Yes	12	0.500	-
44221Y	Fit 'N Forget S.S.	-	-	PC	Gray	No	12	0.500	-
44021Y	Fit 'N Forget S.S.	Fit 'N Forget S.S.	Straight Female PL-3	PC	Gray	No	12	0.500	44221Y lamp, 94789 plug
44227Y	Fit 'N Forget S.S.	-	-	PC	Black	No	12	0.500	-
44027Y	Fit 'N Forget S.S.	Fit 'N Forget S.S.	Straight Female PL-3	PC	Black	No	12	0.500	44227Y lamp, 94789 plug

(KIT)

(KIT)

INCANDESCENT

SUPER 40

SUPER 40[®], FRONT/PARK/TURN, 4" ROUND, GROMMET MOUNT, INCANDESCENT



FEATURES

- Uses standard mounting holes and accessories
- Flush mount grommets are designed for mounting in a 4-1/2" hole
- Uniquely designed shock-mount extends lamp life
- Uses standard mounting holes and accessories
- Upgrade to Truck-Lite LED lighting systems using Super 44 Products

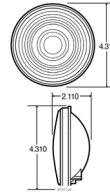

Part Number	Lamp Connector	Plug Side 1	Plug Side 2	Lens Material	Lens Color	Mount Color	Volts	Amps Major	Kit Includes/ Replacement Parts
40202Y	PL-3	-	-	PC	Yellow	-	12	2.1	-

INCANDESCENT

SUPER 40

SUPER 40[®], REAR TURN, 4" ROUND, GROMMET MOUNT, INCANDESCENT



FEATURES

- Uses standard mounting holes and accessories
- Flush mount grommets are designed for mounting in a 4-1/2" hole
- Uniquely designed shock-mount extends lamp life
- Uses standard mounting holes and accessories
- Upgrade to Truck-Lite LED lighting systems using Super 44 Products

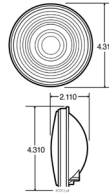

Part Number	Lamp Connector	Plug Side 1	Plug Side 2	Lens Material	Lens Color	Mount Color	Volts	Amps Major	Kit Includes/ Replacement Parts
40201Y	PL-2	-	-	PC	Yellow	-	12	2.1	-
40001Y	PL-2	Right Angle PL-2	Stripped End/ Ring Terminal	PC	Yellow	Black	12	2.1	40201Y lamp, 40700 grommet, 94992 plug KIT

INCANDESCENT

ROUND 1 BULB

ROUND, REAR TURN, 4" , FLANGE MOUNT, INCANDESCENT



FEATURES

- Flush mount lamp with recessed lens
- Stainless steel retaining ring holds lens in place
- Part #81301R shown above
- Upgrade to Truck-Lite LED lighting systems using Super 44 Rear Turn Products

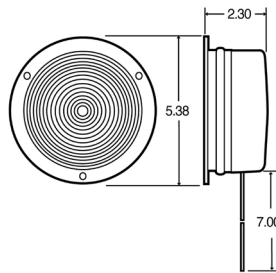

Part Number	Lamp Connector	Plug Side 1	Plug Side 2	Lens Material	Lens Color	Mount Color	Volts	Amps Major	Kit Includes/ Replacement Parts
81300R	Hardwired	Hardwired	Blunt Cut	PC	Red	Black	12	2.1	99008R lens, 97945 retaining ring, 97093 mounting pad, 97094 gasket
81300Y	Hardwired	Hardwired	Blunt Cut	PC	Yellow	Black	12	2.1	99008Y lens, 97945 retaining ring, 97093 mounting pad, 97094 gasket
81301R	Hardwired	Hardwired	Blunt Cut	PC	Red	Silver	12	2.1	99008R lens, 97945 retaining ring, 97093 mounting pad, 97094 gasket
81301Y	Hardwired	Hardwired	Blunt Cut	PC	Yellow	Silver	12	2.1	99008Y lens, 97945 retaining ring, 97093 mounting pad, 97094 gasket

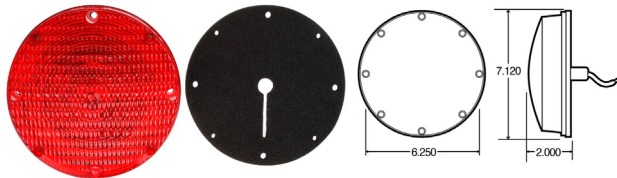

**SIGNAL-STAT, REAR, 6" ROUND,
4 SCREW MOUNT, INCANDESCENT**

FEATURES

- Requires a 1" diameter hole, 1" deep
- Popular lamp on buses and emergency vehicles
- Replaces Signal-Stat 6505/A



Part Number	Lamp Connector	Plug Side 1	Plug Side 2	Lens Material	Lens Color	Volts	Amps Major/Minor	Kit Includes/ Replacement Parts
6503	Hardwired	Hardwired	Stripped End	AC	Red	12	2.1/0.5	99168R lens, 9520 gasket, 9521 mounting pad
6503A	Hardwired	Hardwired	Stripped End	AC	Amber	12	2.1	99168Y lens, 9520 gasket, 9521 mounting pad

INCANDESCENT

SIGNAL-STAT

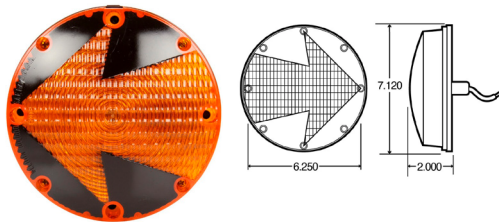

**90 SERIES, 1 BULB, AUXILIARY,
6" , 4 SCREW MOUNT, INCAN., KIT**

FEATURES

- 90325Y lamp functions as a turn signal and features a directional arrow protection
- Requires a 1" diameter hole, 1" deep
- Popular lamp on buses and emergency vehicles
- Replaces Signal-Stat 6505/A



Part Number	Lamp Connector	Plug Side 1	Plug Side 2	Lens Material	Lens Color	Volts	Amps Major	Kit Includes/ Replacement Parts
90325Y	Hardwired	Hardwired	Stripped End	PC	Red	12	2.1	99167Y lamp, 9521 mounting pad, 9520 gasket

INCANDESCENT

90 SERIES

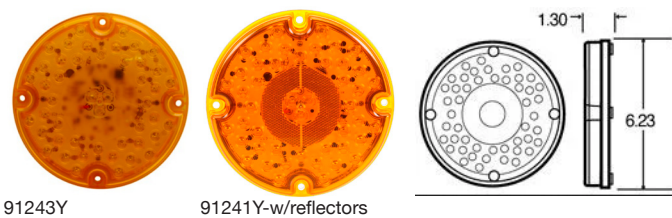

**91 SERIES, REAR TURN,
7" , 4 SCREW MOUNT, LED, 47 DIODES**

FEATURES

- Popular in bus applications
- Features over-voltage and spike protection circuitry



Part Number	Lamp Connector	Plug Side 1	Plug Side 2	Lens Material	Lens Color	Volts	Amps
91241Y	Hardwired	Hardwired	Stripped End	AC	Yellow	12	0.40
91243Y	Hardwired	Hardwired	Stripped End	AC	Yellow	12	.70

LED

91 SERIES

20 SERIES, SIDE TURN, HARDWIRED, 2" ROUND, BRACKET MOUNT, INCANDESCENT



FEATURES

- Features snap-in lens with a 90° maximum edge visibility
- Features side turn function, with two versions also meeting marker/clearance requirements

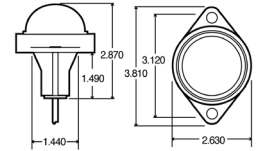
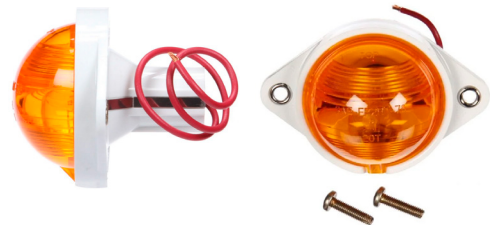

Part Number	Lamp Connector	Plug Side 1	Plug Side 2	Lens Material	Lens Color	Mount Color	Volts	Amps Major/Minor	Kit Includes/ Replacement Parts
20301Y	Hardwired	Hardwired (1 wire)	Stripped End	PC	Yellow	White	12	2.1	99005Y lens, 156 bulb
20304Y	Hardwired	Hardwired (2 wire)	Stripped End	PC	Yellow	White	12	2.1/0.5	99005Y lens, 157 bulb
20316Y	Hardwired	Hardwired	.180 Bullet	PC	Yellow	White	12	2.1/0.5	99005Y lens, 157 bulb



20 SERIES, SIDE TURN, HARDWIRED, 2" ROUND, FLUSH MOUNT, INCANDESCENT



FEATURES

- Features snap-in lens with a 90 degree maximum edge visibility
- Features side turn function
- Available with or without ground wire
- Flush mount

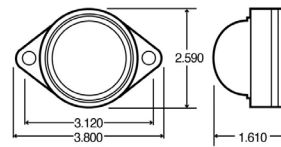
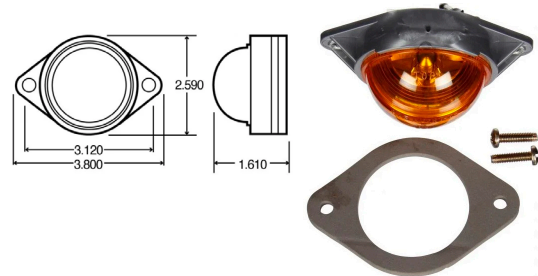

Part Number	Lamp Connector	Plug Side 1	Plug Side 2	Lens Material	Lens Color	Mount Color	Volts	Amps Major/Minor	Kit Includes/ Replacement Parts
20309Y	Hardwired	Hardwired (1 wire)	.180 Bullet	PC	Yellow	Gray	12	1.55	99005Y lens
20310Y	Hardwired	Hardwired (2 wire)	Stripped End	PC	Yellow	Black	12	2.1	80604 bulb



SIGNAL-STAT, 1 BULB, AUXILIARY, 7"X 7" SQUARE, 2 SCREW MOUNT



FEATURES

- Popular school bus signal lamps
- Rimless lens construction
- Positive seal prevents leaking and eliminates cracked lenses
- Double-optic lens covers black enameled steel housing

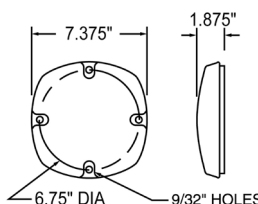
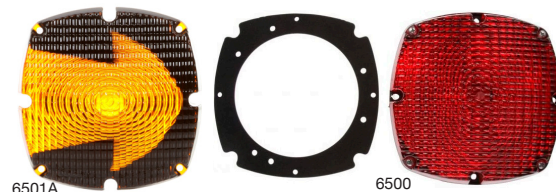

Part Number	Lamp Connector	Plug Side 1	Plug Side 2	Lens Material	Lens Color	Volts	Amps Major	Arrow Lens	Replacement Parts
6500	Hardwired	Hardwired	Stripped End	AC	Red	12	2.1	No	9382 lense, 1156 bulb
6500A	Hardwired	Hardwired	Stripped End	AC	Yellow	12	2.1	No	9382A lense, 1156 bulb
6501A	Hardwired	Hardwired	Stripped End	AC	Yellow	12	2.1	Yes	9384A lense, 1156 bulb

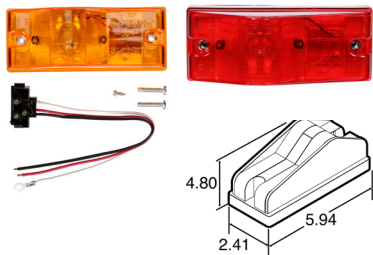

22[®] SERIES, SIDE TURN, 2"X 6" RECTANGULAR, 2 SCREW MOUNT, INCANDESCENT



FEATURES

- Dual contact marker/clearance and side turn or auxiliary rear turn functions
- Mounts on surface of vehicle or with "L" bracket
- Red lamp should be used for rear vehicle applications
- Yellow version exceeds SAEJ2039 side turn and marker standards

Part Number	Lamp Connector	Plug Side 1	Plug Side 2	Mounting Gasket	Lens Color	Volts	Amps Major/Minor	Kit Includes/ Replacement Parts
22202R	PL-3	–	–	No	Red	12	2.1/0.49	–
22002R	PL-3	Right Angle PL-3	Stripped End/ Ring Terminal	No	Red	12	2.1/0.49	22202R light, 94993 plug
22202Y	PL-3	–	–	No	Yellow	12	2.1/0.49	–
22002Y	PL-3	Right Angle PL-3	Stripped End/ Ring Terminal	No	Yellow	12	2.1/0.49	22202Y light, 94993 plug
22006R	PL-3	–	–	Yes	Red	12	2.1/0.49	–
22004R	PL-3	Right Angle PL-3	Stripped End/ Ring Terminal	Yes	Red	12	2.1/0.49	22006R light, 94993 plug
22006Y	PL-3	–	–	Yes	Yellow	12	2.1/0.49	–
22004Y	PL-3	Right Angle PL-3	Stripped End/ Ring Terminal	Yes	Yellow	12	2.1/0.49	22006Y light, 94993 plug
22016Y	PL-3	–	–	Yes /black base	Yellow	12	2.1/0.49	–

INCANDESCENT

22 SERIES

(KIT)

(KIT)

(KIT)

(KIT)



SIGNAL-STAT, GROMMET MOUNT, SIDE TURN, 3"X5", RECTANGULAR, LED, 10 DIODES



FEATURES

- Uses standard right angle PL-3 connection
- 10-diode pattern
- Unique LED array displays full pattern light output
- Epoxy-encapsulated electronics

Part Number	Lamp Connector	Lens Material	Lens Color	Volts	Amps Major/Minor
4558A	PL-3	AC	Yellow	12	0.28/0.03

LED

SIGNAL-STAT

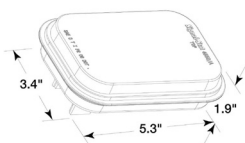

SIGNAL-STAT, GROMMET MOUNT, SIDE TURN, 3"X5", RECTANGULAR, LED, 24 DIODES



FEATURES

- Uses standard right angle PL-3 connection
- 24-diode pattern
- Unique LED array displays full pattern light output
- Epoxy-encapsulated electronics

Part Number	Lamp Connector	Lens Material	Lens Color	Volts	Amps Major/Minor
4550A	PL-3	AC	Yellow	12	0.30/0.04

LED

SIGNAL-STAT



MASTER TRAINING

The Truck-Lite Training Institute offers lighting and harness education to technicians.

Online courses are FREE and available 24/7.

www.truck-lite.com/tti

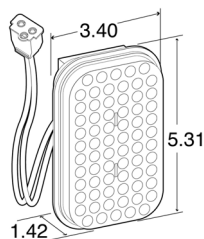

45[®] SERIES, LED, 70 DIODES, 3"X 5" RECTANGULAR, GROMMET MOUNT | KIT



FEATURES

- Hardwired design
- Mounts horizontally or vertically
- Permanently affixed flange-mount version
- Standard connector makes retrofitting easy

Part Number	Lamp Connector	Plug Side 1	Plug Side 2	Lens Material	Mount Color	Volts	Amps	Kit Includes/ Replacement Parts
45251Y	Hardwired	Hardwired	Straight PL-3	PC	–	12	0.500	–
45051Y	Hardwired	Hardwired	Straight PL-3	PC	Black	12	0.500	45251Y lamp, 45700 grommet (KIT)
45263Y	Hardwired	Hardwired	Straight PL-3	PC	–	24	0.300	–
45063Y	Hardwired	Hardwired	Straight PL-3	PC	Black	24	0.300	45263Y lamp, 45700 grommet (KIT)

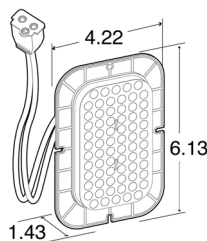

45[®] SERIES, LED, 70 DIODES, 3"X 5" RECTANGULAR, FLANGE MOUNT



FEATURES

- Hardwired design
- Mounts horizontally or vertically
- Permanently affixed flange-mount version
- Standard connector makes retrofitting easy

Part Number	Lamp Connector	Plug Side 1	Plug Side 2	Lens Material	Mount Color	Volts	Amps
45256Y	Hardwired	Hardwired	Straight PL-3	PC	Yellow	12	0.36

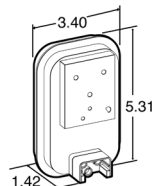

45[®] SERIES, SEALED, REAR TURN, 3"X 5" RECTANGULAR, GROMMET MOUNT



FEATURES

- Direct replacement for approved lamps on United States Postal Service L.L.V. (Long Life Vehicle)
- Designed for mounting on a 7 - 11 degree rollback from the vertical plane

Part Number	Lamp Connector	Plug Side 1	Plug Side 2	Lens Material	Lens Color	Mount Color	Volts	Amps Major/Minor
45021Y	PL-3	Right Angle PL-3	Packard Connector	PC	Yellow	Black	12	2.1

INCANDESCENT

SUPER 45

SUPER 45[®], SEALED, REAR TURN, 3"X 5" RECTANGULAR, GROMMET MOUNT



FEATURES

- Heavy duty bulb for longer life
- Mount horizontally or vertically
- Upgrade to Truck-Lite LED Lighting Systems using 45 Series Products

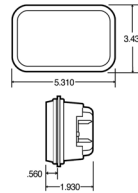

Part Number	Lamp Connector	Plug Side 1	Plug Side 2	Lens Material	Lens Color	Mount Color	Volts	Amps Major/Minor
45201R	PL-3	-	-	AC	Red	Black	12	2.1
45001R	PL-2	Right Angle PL-2	Stripped End/Ring Terminal	PC	Red	Black	12	2.1
45201Y	PL-3	-	-	AC	Yellow	Black	12	2.1
45001Y	PL-2	Right Angle PL-2	Stripped End/Ring Terminal	PC	Yellow	Black	12	2.1



INCANDESCENT

SIGNAL-STAT

SIGNAL-STAT, 2 BULB, AUXILIARY, 3"X 5" RECTANGULAR, 2 SCREW, KIT



FEATURES

- Red for supplementary stop light or turn signal
- Yellow for side turn signal and marker lamp
- Exceeds requirements for mid-trailer turn signal lamps

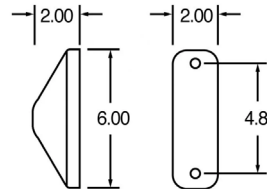

Part Number	Lamp Connector	Plug Side 1	Plug Side 2	Lens Material	Volts	Amps Major/Minor
4095A	Female TA-1415	Right Angle	.180 Bullet Ring Terminal	PC	12	0.31/0.5



INCANDESCENT

1 BULB

4" X 6", REAR TURN, RECTANGULAR, FLANGE MOUNT, SOCKET ASSEMBLY



FEATURES

- Polycarbonate lens and housing are sealed
- Bulb socket cams-in for ease of repair/replacement (sold separately)
- Recess mounts using two screws at 3.0" centers and two screws at 4.2" centers

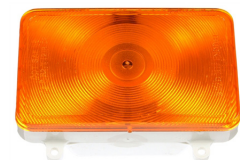
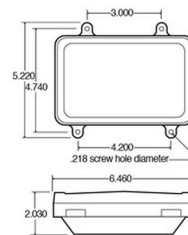

07094

Part Number	Lamp Connector	Lens Material	Lens Color	Volts	Amps Major/Minor
07094	Socket Assembly	PC	Yellow	24	1
07097	Socket Assembly	PC	Yellow	12	2.1



ENCLOSED BACK

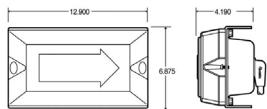

40[®] SERIES, LED, AUXILIARY, 7"X 13" RECTANGULAR, BRACKET MOUNT

FEATURES

- Large outer lens for greater visibility
- Includes slotted bracket for ease of installation and adjustment
- Available with enclosed housing for extra protection



Part Number	Position	Lamp Connector	Plug Side 1	Plug Side 2	Lens Material	Lens Color	Mount Color	Volts	Amps Major
40812	RH	PL-2	PL-2	Ring Terminal	PC	Yellow	Black	12	1.40
40830	LH	PL-2	PL-2	Ring Terminal	PC	Yellow	Black	12	1.40

LED

40 SERIES



OPEN BACK

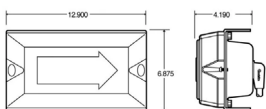

40[®] SERIES, AUXILIARY, INCANDESCENT, 7"X 13" RECTANGULAR, BRACKET MOUNT

FEATURES

- Large outer lens for greater visibility
- Includes slotted bracket for ease of installation and adjustment
- Available with enclosed housing for extra protection
- Use part numbers 40812 and 40830 for LED versions
- 40802/40803 have an open back
- 40804/40805 have an enclosed back/protected



ENCLOSED BACK

Part Number	Position	Lamp Connector	Plug Side 1	Plug Side 2	Lens Material	Lens Color	Mount Color	Volts	Amps Major
40802	LH	PL-3	Right Angle PL-3	Straight Female PL-3	PC	Yellow	Black	12	4.2
40803	RH	PL-3	Right Angle PL-3	Straight Female PL-3	PC	Yellow	Black	12	4.2
40804	LH	PL-2	PL-2	Ring Terminal	PC	Yellow	Black	12	4.2
40805	RH	PL-2	PL-2	Ring Terminal	PC	Yellow	Black	12	4.2

*open back

*open back

*enclosed back

*enclosed back

INCANDESCENT

40 SERIES

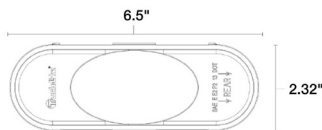
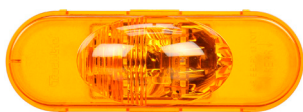

60[®] SERIES, LED, 6 DIODE, SIDE TURN, 2"X 6" OVAL, GROMMET MOUNT

FEATURES

- Complies with SAE J2039 standards; a requirement by California Title 13 law
- Engineered to withstand the toughest working environments on earth
- Commonly mounted at "mid-point" on trailers or "no zone" areas on tractors
- Sealed design locks moisture out
- LEDs have no filament, therefore are not susceptible to shock and vibration
- Less current draw, resulting in increased battery and alternator life while allowing more power for other vehicle requirements



Part Number	Lamp Connector	Plug Side 1	Plug Side 2	Lens Material	Volts	Amps Major/Minor
60421Y	Fit 'N Forget S.S.	-	-	PC	12	0.7/0.05
60422Y	Hardwired	Hardwired	Stripped End	PC	12	0.7/0.05

LED

60 SERIES

LED

60 SERIES

60[®] SERIES, LED, 6 DIODE, SIDE TURN, 2"X 6" OVAL, FLANGE MOUNT



FEATURES

- Complies with SAE J2039 standards; a requirement by California Title 13 law
- Engineered to withstand the toughest working environments on earth
- Commonly mounted at “mid-point” on trailers or “no zone” areas on tractors
- Sealed design locks moisture out
- LEDs have no filament, therefore are not susceptible to shock and vibration
- Less current draw, resulting in increased battery and alternator life while allowing more power for other vehicle requirements

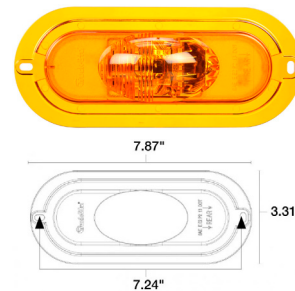

Part Number	Lamp Connector	Plug Side 1	Plug Side 2	Lens Material	Mount Color	Volts	Amps Major/Minor
60420Y	Fit 'N Forget S.S.	–	–	PC	Yellow	12	0.7/0.05
60423Y	Hardwired	Hardwired	Stripped End	PC	Yellow	12	0.7/0.05

LED

60 SERIES

60[®] SERIES, LED, 6 DIODE, SIDE TURN, 2"X 6" OVAL, 2 SCREW MOUNT



FEATURES

- Complies with SAE J2039 standards; a requirement by California Title 13 law
- Available in integral flange, grommet, and surface mount
- Engineered to withstand the toughest working environments on earth
- Commonly mounted at “mid-point” on trailers or “no zone” areas on tractors
- Sealed design locks moisture out
- LEDs have no filament, therefore are not susceptible to shock and vibration
- Less current draw, resulting in increased battery and alternator life while allowing more power for other vehicle requirements

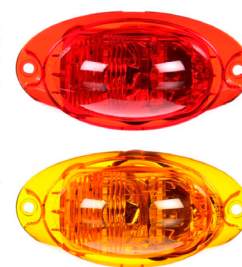
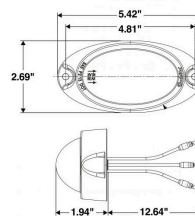

Part Number	Lamp Connector	Plug Side 1	Plug Side 2	Lens Material	Lens Color	Volts	Amps Major/Minor
60424R	Hardwired	Hardwired	.180 bullet	PC	Red	12	0.6/0.04
60424Y	Hardwired	Hardwired	.180 bullet	PC	Yellow	12	0.6/0.04
60425Y	Hardwired	Hardwired	Stripped End	PC	Yellow	12	0.6/0.04

LED

60 SERIES

60[®] SERIES, LED, 25 DIODES, AUXILIARY, 2"X 6" OVAL, GROMMET MOUNT



FEATURES

- Auxiliary turn is a two-function lamp and complies with SAE 592E and 2042 on both functions
- Sequential arrow is to be used as an auxiliary lamp only and requires a 50% on time flasher, part #97231
- Not suitable for “stand alone” front or rear turn applications
- Electronics completely sealed in epoxy to resist corrosion and moisture

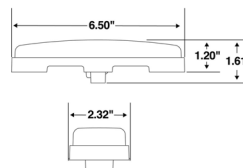

Part Number	Lamp Connector	Plug Side 1	Plug Side 2	Lens Material	Volts	Amps Major/Minor	Kit Includes/ Replacement Parts
60280Y	Fit 'N Forget S.S.	–	–	PC	12	0.12/0.08	–
60080Y	Fit 'N Forget S.S.	Fit 'N Forget S.S.	Straight Female PL-3	PC	12	0.12/0.08	60280Y lamp, 60700 grommet, 94706 plug



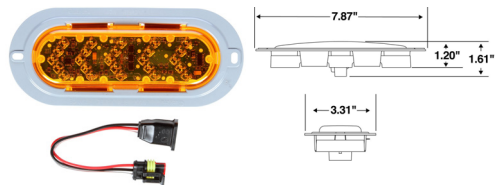

60[®] SERIES, LED, 25 DIODES, AUXILIARY, 2"X 6" OVAL, FLANGE MOUNT

FEATURES

- Auxiliary turn is a two-function lamp and complies with SAE 592E and 2042 on both functions
- Use part #60315Y for LED side turn applications SAE J2039
- Sequential arrow is to be used as an auxiliary lamp only and requires a 50% on time flasher, part #97231
- Not suitable for “stand alone” front or rear turn applications
- Electronics completely sealed in epoxy to resist corrosion and moisture



Part Number	Lamp Connector	Plug Side 1	Plug Side 2	Lens Material	Mount Color	Volts	Amps Major/Minor	Kit Includes/ Replacement Parts
60282Y	Fit 'N Forget S.S.	–	–	PC	Gray	12	0.12/0.08	–
60286Y	Fit 'N Forget S.S.	–	–	PC	Black	12	0.12/0.08	–
60082Y	Fit 'N Forget S.S.	Fit 'N Forget S.S.	Straight Female PL-3	PC	Gray	12	0.12/0.08	60282Y lamp, 94706 plug

(KIT)

LED
60 SERIES

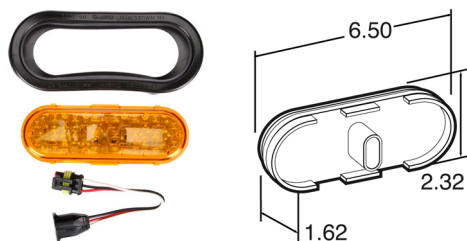

60[®] SERIES, LED, 26 DIODES, AUXILIARY, 2"X 6" OVAL, GROMMET MOUNT

FEATURES

- Auxiliary turn is a two-function lamp and complies with SAE 592E and 2042 on both functions
- Sequential arrow is to be used as an auxiliary lamp only and requires a 50% on time flasher, part #97231
- Not suitable for “stand alone” front or rear turn applications
- Electronics completely sealed in epoxy to resist corrosion and moisture



Part Number	Lamp Connector	Plug Side 1	Plug Side 2	Lens Material	Volts	Amps Major/Minor	Kit Includes/ Replacement Parts
60275Y	Fit 'N Forget S.S.	–	–	PC	12	0.42/0.1	–
60075Y	Fit 'N Forget S.S.	Fit 'N Forget S.S.	Straight Female PL-3	PC	12	0.42/0.1	60275Y lamp, 60700 grommet, 94706 plug
60255Y	Fit 'N Forget S.S.	–	–	PC	24	0.18/0.06	–
60891Y	Fit 'N Forget S.S.	–	–	AC	12	0.42/0.1	–

(KIT)

LED
60 SERIES

LED
60 SERIES

**60[®] SERIES, LED, 26 DIODES,
AUXILIARY, 2"X 6" OVAL, FLANGE MOUNT | KIT**



FEATURES

- Auxiliary turn is a two-function lamp and complies with SAE 592E and 2042 on both functions
- Not suitable for “stand alone” front or rear turn applications
- Electronics completely sealed in epoxy to resist corrosion and moisture

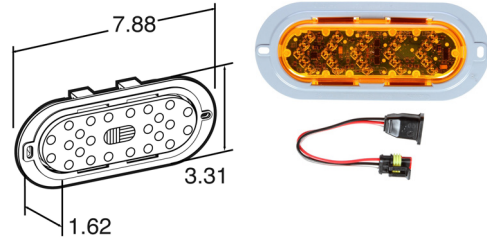

Part Number	Lamp Connector	Plug Side 1	Plug Side 2	Lens Material	Mount Color	Volts	Amps Major/Minor	Kit Includes/ Replacement Parts
60272Y	Fit 'N Forget S.S.	–	–	PC	Gray	12	0.42/0.1	–
60072Y	Fit 'N Forget S.S.	Fit 'N Forget S.S.	Straight Female PL-3	PC	Gray	12	0.42/0.08	94706 plug, 60272Y lamp (KIT)
60276Y	Fit 'N Forget S.S.	–	–	PC	Black	12	0.42/0.1	–
60872Y	Fit 'N Forget S.S.	–	–	AC	Gray	12	0.42/0.1	–

LED
60 SERIES

**60[®] SERIES, LED, 26 DIODES,
REAR, 2"X 6" OVAL, GROMMET MOUNT, KIT**



FEATURES

- Increases vehicle conspicuity with intense displays of light output
- LED Versions rated at 100,000 hours of operation
- Extended period of operation translates to less vehicle downtime and zero maintenance
- Designed for LLV postal applications

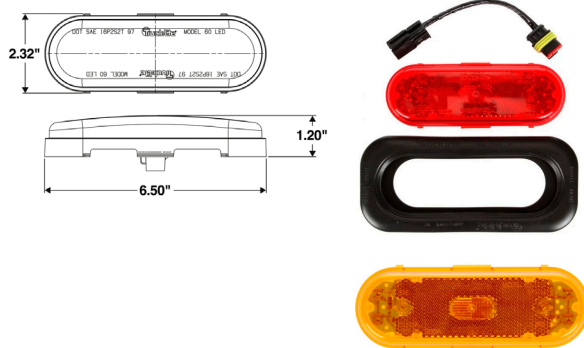

Part Number	Lamp Connector	Plug Side 1	Plug Side 2	Lens Material	Mount Color	Volts	Amps Major/Minor	Kit Includes/ Replacement Parts
60180R	Fit 'N Forget S.S.	Fit 'N Forget S.S.	Packard Connector 12020398	PC	Black	12	0.42/0.08	60701 grommet, 95034 plug, 60380R lamp (KIT)
60180Y	Fit 'N Forget S.S.	Fit 'N Forget S.S.	Packard Connector 12020398	PC	Black	12	0.42/0.1	60380Y lamp, 60701 grommet, 95036 plug (KIT)

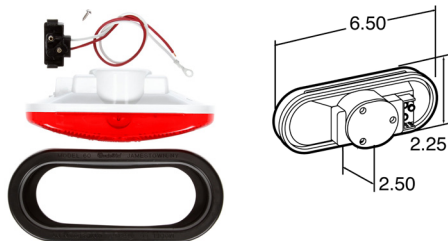

**SUPER 60[®], 1 BULB, AUXILIARY,
2"X 6" OVAL, GROMMET MOUNT**

FEATURES

- Mount horizontally or vertically
- Upgrade to Truck-Lite LED lighting systems using 60 Series LED Products



Part Number	Lamp Connector	Plug Side 1	Plug Side 2	Lens Material	Lens Color	Volts	Amps Major/Minor	Kit Includes/ Replacement Parts
60001R	PL-2	Right Angle PL-2	Stripped End/ Ring Terminal	PC	Red	12	2.1	60201R, 94992 plug, 60700 grommet
60001Y	PL-2	Right Angle PL-2	Stripped End/ Ring Terminal	PC	Yellow	12	2.1	60201Y, 94992 plug, 60700 grommet
60007Y	PL-3	PL-3	Stripped End/ Ring Terminal	PC	Yellow	24	2.1	60207Y, 94993 plug, 60700 grommet

KIT

KIT

KIT

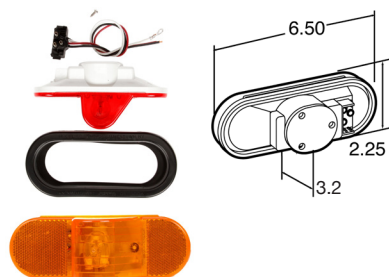

**60[®] SERIES, SIDE TURN
2"X 6" OVAL, GROMMET MOUNT,
INCANDESCENT, KIT**

FEATURES

- Features side indicator, marker/clearance and reflector functions
- Narrow width facilitates horizontal mounting
- Red lamp should be used only for rear vehicle applications
- Meets SAE J2039 recommendation for side turn signal
- Upgrade to Truck-Lite LED lighting systems using Super 60 LED products



Part Number	Lamp Connector	Plug Side 1	Plug Side 2	Lens Material	Lens Color	Mount Color	Volts	Amps Major/Minor	Kit Includes/ Replacement Parts
60215R	PL-3	-	-	PC	Yellow	Black	12	2.1/0.49	-
60015R	PL-3	Right Angle PL-3	Stripped End/ Ring Terminal	PC	Red	Black	12	2.1/0.49	60215R, 94993 plug, 60700 grommet
60215Y	PL-3	-	-	PC	Yellow	Black	12	2.1/0.49	-
60015Y	PL-3	Right Angle PL-3	Stripped End/ Ring Terminal	PC	Yellow	Black	12	2.1/0.49	60215Y, 94993 plug, 60700 grommet
60217Y	PL-3	-	-	PC	Yellow	Black	24	1/0.36	-

KIT

KIT



**60[®] SERIES, REAR TURN
2"X 6" OVAL, GROMMET MOUNT,
INCANDESCENT**

FEATURES

- Narrow width facilitates horizontal mounting
- Red lamp should be used only for rear vehicle applications
- Upgrade to Truck-Lite LED lighting systems using Super 60 LED products



Part Number	Lamp Connector	Plug Side 1	Plug Side 2	Lens Material	Lens Color	Mount Color	Volts	Amps Major/Minor	Kit Includes/ Replacement Parts
60344Y	Socket Assembly	Socket Assembly	Stripped End/ Ring Terminal	PC	Yellow	Black	12	2.1/0.59	99184Y lens, 60700 grommet, 95415 socket

KIT

INCANDESCENT

SUPER 60

SUPER 60[®], REAR TURN, 2"X 6" OVAL, GROMMET MOUNT, INCANDESCENT



FEATURES

- Mounts horizontally or vertically
- Upgrade to Truck-Lite LED lighting systems using 60 Series LED products

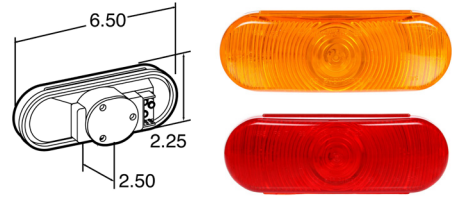

Part Number	Lamp Connector	Lens Material	Lens Color	Volts	Amps Major/Minor
60201R	PL-3	PC	Red	12	2.1
60201Y	PL-3	PC	Yellow	12	2.1

INCANDESCENT

SIGNAL-STAT

SIGNAL-STAT, AUXILIARY, 2"X 6" OVAL, 2 SCREW MOUNT, INCANDESCENT



FEATURES

- Red for supplementary stop light or turn signal
- Yellow for side turn signal and marker lamp
- Exceeds requirements for mid-trailer turn signal lamps
- For Navistar #1677711C91 replacement use Signal Stat #4091A

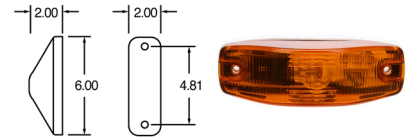

Part Number	Lamp Connector	Plug Side 1	Plug Side 2	Lens Material	Lens Color	Volts	Amps Major/Minor	Kit Includes	Other
4091	Female TA-1415	-	-	PC	Red	12	2.1/0.5	-	Bulb Replaceable
4091A	Female TA-1415	-	-	PC	Yellow	12	2.1/0.5	-	Bulb Replaceable
4094	Female TA-1415	Right Angle Plug	.180 Bullet Ring Terminal	PC	Red	12	2.1/0.5	4091 light, 9463 plug	Bulb Replaceable (KIT)
4094A	Female TA-1415	Right Angle Plug	.180 Bullet Ring Terminal	PC	Yellow	12	2.1/0.5	4091A light, 9463 plug	Bulb Replaceable (KIT)
4093	Female TA-1415	-	-	PC	Red	12	2.1/0.5	-	Sealed
4093A	Female TA-1415	-	-	PC	Yellow	12	2.1/0.5	-	Sealed
4095	Female TA-1415	Right Angle Plug	.180 Bullet Ring Terminal	PC	Red	12	2.1/0.5	4093 light, 9463 plug	Sealed (KIT)
4095A	Female TA-1415	Right Angle Plug	.180 Bullet Ring Terminal	PC	Yellow	12	2.1/0.5	4093 light, 9463 plug	Sealed (KIT)

INCANDESCENT

OVAL 1 BULB

OVAL, SIDE TURN, GROMMET MOUNT, 2"X 6" OVAL, INCANDESCENT



FEATURES

- Male pin connections
- Features side indicator, marker/clearance and reflector functions
- Narrow width facilitates horizontal mounting
- Meets SAE J2039 recommendation for side turn signal
- Replaces Grote #52533
- Upgrade to Truck-Lite LED lighting systems using Super 60 LED lamps

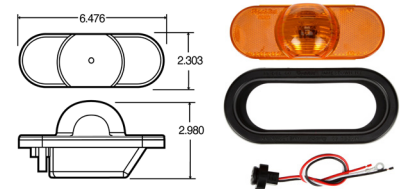

Part Number	Lamp Connector	Plug Side 1	Plug Side 2	Lens Material	Lens Color	Mount Color	Volts	Amps Major/Minor	Kit Includes/ Replacement Parts
69202Y	Male Pin	-	-	PC	Yellow		12	2.1/0.5	-
69002Y	Male Pin	Female PL-3	Stripped End/ Ring Terminal	PC	Yellow	Black	12	2.1/0.5	69202Y lamp, 96107 plug, 60700 grommet (KIT)

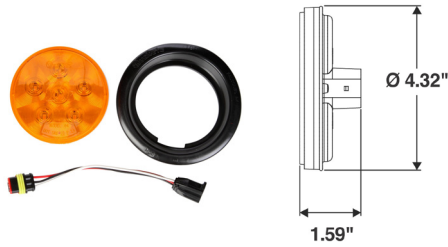

**SUPER 44[®], LED, 6 DIODES,
4" ROUND, GROMMET MOUNT**

FEATURES

- Uses less current draw
- LEDs do not have a filament, therefore are not susceptible to damage from shock and vibration
- Flange mounts are permanently affixed to light
- Designed to comply with FMVSS 108



Part Number	Lamp Connection	Plug Side 1	Plug Side 2	Lens Material	Lens Color	Volts	Amps Major/Minor	Diamond Shell	Kit Includes/ Replacement Parts
44294Y	Fit 'N Forget S.S.	-	-	PC	Yellow	12	0.03/0.59	No	-
44094Y	Fit 'N Forget S.S.	Fit 'N Forget S.S.	Female PL-3	PC	Yellow	12	0.03/0.59	No	44294Y light, 40700 grommet, 94706 plug
44291Y	Fit 'N Forget S.S.	-	-	AC	Yellow	12	0.03/0.59	Yes	-
44091Y	Fit 'N Forget S.S.	Fit 'N Forget S.S.	Female PL-3	AC	Yellow	12	0.03/0.59	Yes	44291Y light, 40700 grommet, 94760 plug

(KIT)

(KIT)

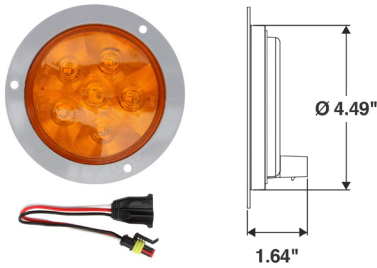

**SUPER 44[®], LED, 6 DIODES,
4" ROUND, FLANGE MOUNT**

FEATURES

- Uses less current draw
- LEDs do not have a filament, therefore are not susceptible to damage from shock and vibration
- Flange mounts are permanently affixed to light
- Designed to comply with FMVSS 108



Part Number	Lamp Connection	Plug Side 1	Plug Side 2	Lens Material	Lens Color	Mount/ Trim Color	Volts	Amps Major/Minor	Diamond Shell	Kit Includes/ Replacement Parts
44292Y	Fit 'N Forget S.S.	-	-	PC	Yellow	Black	12	0.03/0.59	No	-
44092Y	Fit 'N Forget S.S.	Fit 'N Forget S.S.	Female PL-3	PC	Yellow	Black	12	0.03/0.59	No	44292Y light, 94706 plug
44293Y	Fit 'N Forget S.S.	-	-	PC	Yellow	White	12	0.03/0.59	No	-
44093Y	Fit 'N Forget S.S.	Fit 'N Forget S.S.	Female PL-3	PC	Yellow	White	12	0.03/0.59	No	44293Y light, 94706 plug
44295Y	Fit 'N Forget S.S.	-	-	PC	Yellow	Gray	12	0.03/0.59	No	-
44095Y	Fit 'N Forget S.S.	Fit 'N Forget S.S.	Female PL-3	PC	Yellow	Gray	12	0.03/0.59	No	44295Y light, 94706 plug

(KIT)

(KIT)

(KIT)

LED
SIGNAL-STAT

**SIGNAL-STAT, LED, 10 DIODES,
4" ROUND, GROMMET MOUNT**



FEATURES

- Uses standard PL-3 connector
- Designed with impact-resistant acrylic material

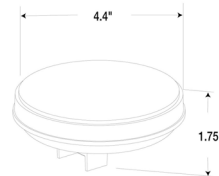

Part Number	Lamp Connection	Lens Material	Lens Color	Volts	Amps Major/Minor
4058A	PL-3	AC	Yellow	12	0.50/0.025

LED
SIGNAL-STAT

**SIGNAL-STAT, LED, 24 DIODES,
4" ROUND, GROMMET MOUNT**



FEATURES

- Popular on owner/operator show trucks
- Uses standard right angle connection
- Unique LED array displays a full pattern light output design
- Epoxy-encapsulated electronics prevents damage from moisture and corrosion
- Less current draw
- LEDs do not have a filament, therefore are not susceptible to damage from shock and vibration

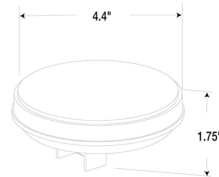

Part Number	Lamp Connection	Lens Material	Lens Color	Volts	Amps Major/Minor
4050A	PL-3	PC	Yellow	12	0.03/0.38
4051A	PL-3	PC	Clear	12	0.03/0.38

LED
SIGNAL-STAT

**SIGNAL-STAT, LED, 24 DIODES,
4" ROUND, FLANGE MOUNT**



FEATURES

- Housing and flange are molded together to form one piece
- Uses standard right angle PL-3 connection
- Designed with impact-resistant polycarbonate material
- LEDs do not have a filament, therefore are not susceptible to damage from shock and vibration
- Epoxy-encapsulated electronics prevents damage from moisture and corrosion
- When properly mounted, exceeds FMVSS DOT requirements for S/T/T and F/P/T

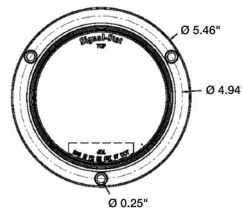

Part Number	Lamp Connection	Lens Material	Lens Color	Mount/Trim Color	Volts	Amps Major/Minor
4053A	PL-3	PC	Yellow	Gray	12	0.290/0.05

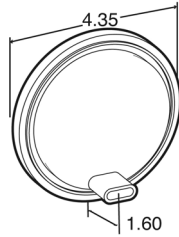

**SUPER 44[®], LED, 60 DIODES,
4" ROUND, GROMMET MOUNT**

FEATURES

- LEDs do not have a filament, therefore are not susceptible to damage from shock and vibration
- Less current draw, resulting in increased battery and alternator life while allowing more power for other vehicle requirements
- Front, Park and Turn lamps meet stringent SAE and NHTSA requirements



Part Number	Lamp Connection	Plug Side 1	Plug Side 2	Lens Material	Lens Color	Mount/Trim Color	Volts	Amps Major/Minor	Diamond Shell	Kit Includes/Replacement Parts
44203Y	Fit 'N Forget S.S.	-	-	PC	Yellow	Black	12	0.1/0.75	No	-
44003Y	Fit 'N Forget S.S.	Fit 'N Forget S.S.	Straight Female PL-3	PC	Yellow	Black	12	0.1/0.75	No	44203Y light, 94706 plug, 40700 grommet (KIT)
44871Y	Fit 'N Forget S.S.	-	-	AC	Yellow	Black	12	0.1/0.75	Yes	-
44071Y	Fit 'N Forget S.S.	Fit 'N Forget S.S.	Straight Female PL-3	AC	Yellow	Black	12	0.1/0.75	Yes	44871Y light, 94706 plug, 40700 grommet (KIT)

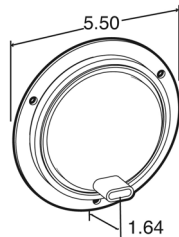

**SUPER 44[®], LED, 60 DIODES,
4" ROUND, FLANGE MOUNT**

FEATURES

- LEDs do not have a filament, therefore are not susceptible to damage from shock and vibration
- Less current draw, resulting in increased battery and alternator life while allowing more power for other vehicle requirements
- Front, Park and Turn lamps meet stringent SAE and NHTSA requirements



Part Number	Lamp Connection	Plug Side 1	Plug Side 2	Lens Material	Lens Color	Mount/Trim Color	Volts	Amps Major/Minor	Diamond Shell	Kit Includes/Replacement Parts
44223Y	Fit 'N Forget S.S.	-	-	PC	Yellow	Gray	12	0.1/0.75	No	-
44023Y	Fit 'N Forget S.S.	Fit 'N Forget S.S.	Straight Female PL-3	PC	Yellow	Gray	12	0.1/0.75	No	44223Y light, 94706 plug (KIT)
44224Y	Fit 'N Forget S.S.	-	-	PC	Yellow	Black	12	0.1/0.75	No	-
44024Y	Fit 'N Forget S.S.	Fit 'N Forget S.S.	Straight Female PL-3	PC	Yellow	Black	12	0.1/0.75	No	44224Y light, 94706 plug (KIT)
44233Y	Fit 'N Forget S.S.	-	-	PC	Yellow	White	12	0.1/0.75	No	-
44877Y	Fit 'N Forget S.S.	-	-	AC	Yellow	Gray	12	0.1/0.75	Yes	-
44878Y	Fit 'N Forget S.S.	-	-	AC	Yellow	Black	12	0.1/0.75	Yes	-

40[®] SERIES, GROMMET MOUNT, 4" ROUND, INCANDESCENT



FEATURES

- Heavy duty shock-mounted bulb
- Uses standard mounting holes & accessories
- High impact polycarbonate construction
- 24 month limited warranty

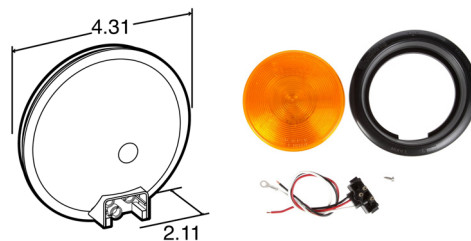

Part Number	Lamp Connection	Plug Side 1	Plug Side 2	Lens Material	Lens Color	Mount/Trim Color	Volts	Amps Major/Minor	Kit Includes/Replacement Parts
40202Y	PL-3	-	-	PC	Yellow	Black	12	2.1 / 0.48	-
40002Y	PL-3	Right Angle PL-3	Stripped End/Ring Terminal	PC	Yellow	Black	12	2.1 / 0.48	40202Y light, 94993 plug, 40700 grommet (KIT)
40209Y	PL-3	-	-	PC	Yellow	Black	24	0.93 / 0.34	-
40009Y	PL-3	Right Angle PL-3	Stripped End/Ring Terminal	PC	Yellow	Black	24	0.93 / 0.34	40209Y light, 94993 plug, 40700 grommet (KIT)
40206Y	PL-3	-	-	PC	Yellow/Clear Back	Black	12	2.1 / 0.48	-

40[®] SERIES, BULB REPLACEABLE, 4" ROUND, GROMMET MOUNT



FEATURES

- Heavy duty shock-mounted bulb
- Uses standard mounting holes & accessories
- High impact polycarbonate construction
- 24 month limited warranty

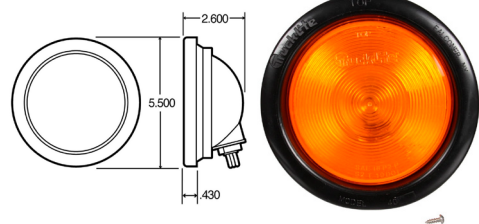

Part Number	Lamp Connection	Plug Side 1	Plug Side 2	Lens Material	Lens Color	Mount/Trim Color	Volts	Amps Major/Minor	Kit Includes/Replacement Parts
40302Y	Socket Assembly	Socket Assembly	Stripped End/Ring Terminal	PC	Yellow	Black	12	2.1 / 0.48	40700 grommet, 94938 socket/bulb, 99010Y lens/housing (KIT)

40[®] SERIES, FLANGE MOUNT, 4" ROUND, INCANDESCENT



FEATURES

- Heavy-duty bulb for long-lasting life
- Uniquely designed shock mount extends lamp life
- Available with or without reflectorized lens
- Flush-mount grommets are designed for mounting in a 4 1/2" hole
- Upgrade to LED lighting systems using Truck-Lite's Super 44 series of products

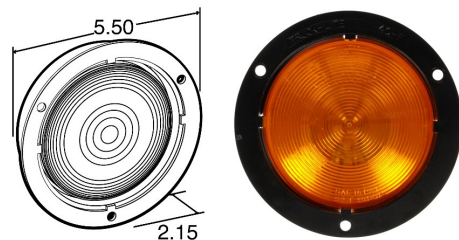

Part Number	Lamp Connection	Lens Material	Lens Color	Mount/Trim Color	Volts	Amps Major/Minor
40233Y	PL-3	PC	Yellow	Black	12	2.1 / 0.48

INCANDESCENT

40 SERIES

INCANDESCENT

40 SERIES

INCANDESCENT

40 SERIES

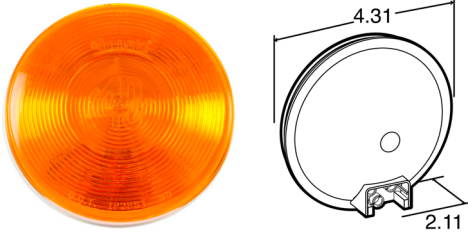

**SUPER 40[®], GROMMET MOUNT,
4" ROUND, INCANDESCENT**

FEATURES

- Uniquely designed shock-mount extends lamp life
- Uses standard mounting holes & accessories
- High impact polycarbonate construction



Part Number	Lamp Connection	Lens Material	Lens Color	Volts	Amps Major/Minor
40242Y	PL-3	PC	Yellow	12	2.1 / 0.48

INCANDESCENT

SUPER 40

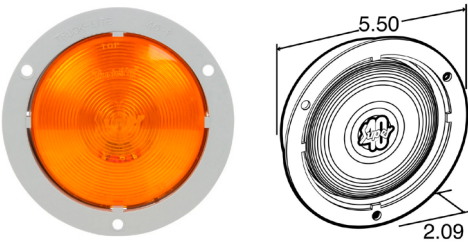

**SUPER 40[®], FLANGE MOUNT,
4" ROUND, INCANDESCENT**

FEATURES

- Uniquely designed shock-mount extends lamp life
- Flange kits feature a high-impact plastic affixed to lamp
- Uses standard mounting holes & accessories
- High impact polycarbonate construction



Part Number	Lamp Connection	Lens Material	Lens Color	Mount Color	Volts	Amps Major/Minor
40258Y	PL-3	PC	Yellow	Grey	12	2.1 / 0.47

INCANDESCENT

SUPER 40

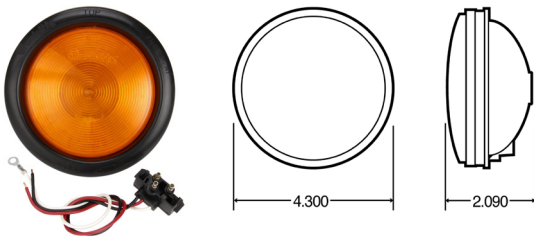

**40[®] ECONOMY, GROMMET MOUNT,
4" ROUND, INCANDESCENT**

FEATURES

- Grommet kit features flush mounting in a 4 1/2" hole
- Uses standard mounting holes & accessories
- High impact polycarbonate construction



Part Number	Lamp Connection	Plug Side 1	Plug Side 2	Lens Material	Lens Color	Mount/Trim Color	Volts	Amps Major/Minor	Kit Includes/Replacement Parts
40282Y	PL-3	-	-	PC	Yellow	Black	12	2.1 / 0.48	-
40028Y	PL-3	Right Angle PL-3	Stripped End/Ring Terminal	PC	Yellow	Black	12	2.1 / 0.48	40282Y light, 94993 plug, 40700 grommet

INCANDESCENT

40 ECONOMY



TRUCK-LITE, INCANDESCENT, 4" ROUND, FLANGE MOUNT



FEATURES

- Mounts flush to vehicle
- Retaining ring allows for easy bulb replacement
- Not intended for use as (P2) clearance
- Upgrade to Truck-Lite LED lighting systems using Super 44 products

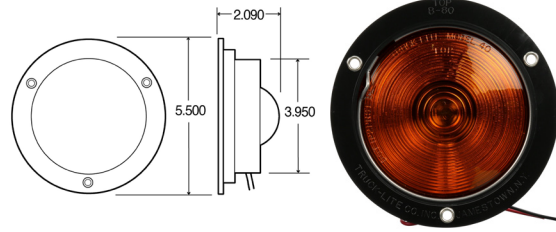

Part Number	Lamp Connection	Plug Side 1	Plug Side 2	Lens Material	Lens Color	Mount/Trim Color	Volts	Amps Major/Minor
80302Y	Hardwired	Hardwired	Blunt Cut	AC	Yellow	Black	12	2.47 / 0.48

91[®] SERIES, INCANDESCENT, 7" ROUND, 4 SCREW MOUNT



FEATURES

- Contains a heavy-duty, shock-mount, 12 volt bulb
- Mounting gasket provides additional protection between lamp and body
- Mounts in a 5.375" hole

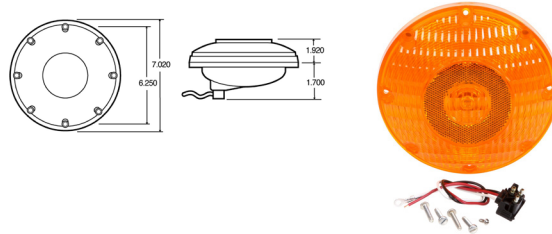

Part Number	Lamp Connection	Plug Side 1	Plug Side 2	Lens Material	Lens Color	Mount/Trim Color	Volts	Amps Major/Minor	Kit Includes/Replacement Parts
91002Y	PL-3	Right Angle PL-3	Stripped End/Ring Terminal	PC	Yellow	Yellow	12	2.1 / 0.48	91202Y light, 94993 plug (KIT)
91202Y	PL-3	-	-	PC	Yellow	Yellow	12	2.1 / 0.48	-
91205Y	PL-3	-	-	PC	Yellow	Yellow	24	0.93 / 0.34	-
91315Y	Socket Assembly	Socket Assembly	Stripped End/Ring Terminal	PC	Yellow	Yellow	12	2.1 / 0.59	99021Y lens/housing, 95407 socket and bulb (KIT)

7" ROUND, INCANDESCENT, 4 SCREW MOUNT



FEATURES

- Surface mounts with four bolts on a 6.25" bolt circle
- Requires a 1" diameter hole, 1" deep
- Popular lamp on buses and emergency vehicles
- Replaces Signal-Stat 6504

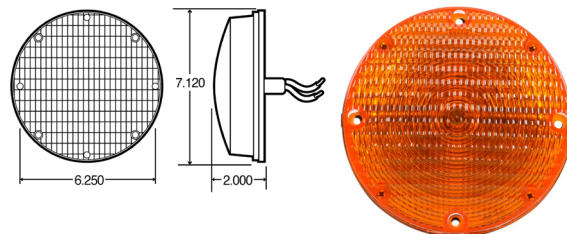

Part Number	Lamp Connection	Plug Side 1	Plug Side 2	Lens Material	Lens Color	Mount/Trim Color	Volts	Amps Major/Minor	Kit Includes/Replacement Parts
90327Y	Hardwired	Hardwired	Blunt Cut	AC	Yellow	Yellow	12	2.1 / 0.59	99168Y lens, 1157 bulb, 9520 gasket

INCANDESCENT

4 IN ROUND

INCANDESCENT

91 SERIES

INCANDESCENT

7 IN ROUND

**SIGNAL-STAT, LED, 10 DIODES,
2" X 6" OVAL, GROMMET MOUNT**

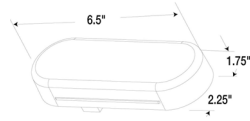
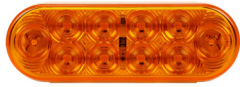

FEATURES

- Engineered to feature ten bright and economical light emitting diodes (LEDs)
- When properly mounted, exceeds FMVSS-P2 DOT requirements for marker/clearance performance
- Designed with impact-resistant acrylic material
- Sealed lens and housing locks moisture out
- LEDs do not have a filament, therefore are not susceptible to shock and vibration damage major cause of failure for lamps with an incandescent bulb
- Epoxy-encapsulated electronics prevents damage from moisture and corrosion

Part Number	Lamp Connection	Lens Material	Lens Color	Volts	Amps Major/Minor	Diamond Shell
6058A	PL-3	AC	Yellow	12	0.55/0.025	No

LED

SIGNAL-STAT

**SIGNAL-STAT, LED, 24 DIODES,
2" X 6" OVAL, GROMMET MOUNT**

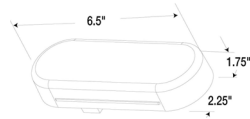

FEATURES

- Popular for owner/operator show trucks
- Uses standard right angle plug
- Unique LED array displays full pattern light output design
- Epoxy-encapsulated electronics prevents damage from moisture and corrosion

Part Number	Lamp Connection	Lens Material	Lens Color	Volts	Amps Major/Minor	Diamond Shell
6050A	PL-3	PC	Yellow	12	0.38 / 0.03	No
6051A	PL-3	PC	Clear	12	0.38 / 0.03	No

LED

SIGNAL-STAT

**SIGNAL-STAT, LED, 24 DIODES,
2" X 6" OVAL, FLANGE MOUNT**

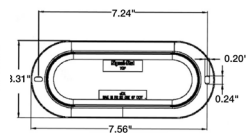

FEATURES

- Housing and flange are molded together to form one piece
- Uses standard right angle PL-3 connection
- Designed with impact-resistant polycarbonate material
- LEDs do not have a filament, therefore are not susceptible to shock and vibration damage major cause of failure for lamps with an incandescent bulb
- Epoxy-encapsulated electronics prevents damage from moisture and corrosion
- When properly mounted, exceeds FMVSS DOT requirements for F/P/T

Part Number	Lamp Connection	Lens Material	Lens Color	Mount/Trim Color	Volts	Amps Major/Minor	Diamond Shell
6053A	PL-3	PC	Yellow	Gray	12	0.26 / 0.02	No

LED

SIGNAL-STAT

LED

60 SERIES

60[®] SERIES, LED, 44 DIODES, 2" X 6" OVAL, GROMMET MOUNT



FEATURES

- Meets stringent Front, Park and Turn requirements
- LEDs do not have a filament, therefore are not susceptible to damage from shock and vibration
- Less current draw

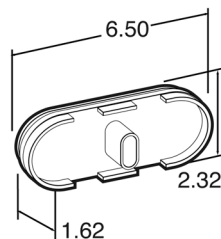

Part Number	Lamp Connection	Plug Side 1	Plug Side 2	Lens Material	Lens Color	Mount/Trim Color	Volts	Amps Major/Minor	Diamond Shell	Kit Includes/Replacement Parts
60290Y	Fit 'N Forget S.S.	-	-	PC	Yellow	Black	12	0.55 / 0.08	No	-
60094Y	Fit 'N Forget S.S.	Fit 'N Forget S.S.	Straight Female PL-3	PC	Yellow	Black	12	0.55 / 0.08	No	60290Y lamp, 94706 plug, 60700 grommet
60074Y	Fit 'N Forget S.S.	Fit 'N Forget S.S.	Packard Connector 12015793	PC	Yellow	Black	12	0.55 / 0.08	No	60290Y lamp, 95986 plug, 60701 grommet
60892Y	Fit 'N Forget S.S.	-	-	AC	Yellow	Black	12	0.55 / 0.08	Yes	-

KIT

KIT

LED

60 SERIES

60[®] SERIES, LED, 44 DIODES, 2" X 6" OVAL, FLANGE MOUNT



FEATURES

- Meets stringent Front, Park and Turn requirements
- LEDs do not have a filament, therefore are not susceptible to damage from shock and vibration
- Less current draw

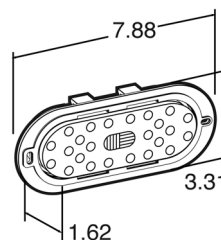

Part Number	Lamp Connection	Plug Side 1	Plug Side 2	Lens Material	Lens Color	Mount/Trim Color	Volts	Amps Major/Minor	Diamond Shell	Kit Includes/Replacement Parts
60291Y	Fit 'N Forget S.S.	-	-	PC	Yellow	Gray	12	0.55 / 0.09	No	-
60096Y	Fit 'N Forget S.S.	Fit 'N Forget S.S.	Straight Female PL-3	PC	Yellow	Gray	12	0.55 / 0.09	No	60291Y light, 94706 plug
60292Y	Fit 'N Forget S.S.	-	-	PC	Yellow	Black	12	0.55 / 0.09	No	-
60097Y	Fit 'N Forget S.S.	Fit 'N Forget S.S.	Straight Female PL-3	PC	Yellow	Black	12	0.55 / 0.09	No	60292Y light, 94706 plug

KIT

KIT

INCANDESCENT

60 SERIES

60[®] SERIES, INCANDESCENT, 2"X 6" OVAL, GROMMET MOUNT, KIT



FEATURES

- Direct replacement for approved lamps on the United States Postal Service L.L.V (Long Life Vehicles)
- Features a heavy-duty shock-mounted bulb
- Four versions, each features center high mount stop functions, park and turn functions, rear side marker and turn functions, or front side marker and turn signal functions

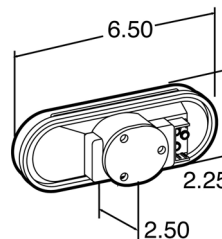

Part Number	Lamp Connection	Plug Side 1	Plug Side 2	Lens Material	Lens Color	Mount/Trim Color	Volts	Amps Major/Minor	Kit Includes/Replacement Parts
60202Y	PL-3	-	-	PC	Yellow		12	2.1 / 0.48	-
60022Y	PL-3	Right Angle PL-3	Stripped End/ Ring Terminal	PC	Yellow	Black	12	2.1 / 0.48	60202Y light, 60701 grommet, 94839 plug

KIT

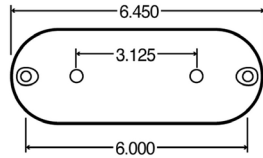

**60[®] SERIES, INCANDESCENT,
2"X 6" OVAL, GROMMET MOUNT, KIT**

FEATURES

- Lamp may be either grommet or screw mounted
- Mounts horizontally or vertically
- .250 Internal Knockout hole / 1.620 Clearance hole
- Upgrade to Truck-Lite LED Lighting Systems using 60 Series LED products



Part Number	Lamp Connection	Plug Side 1	Plug Side 2	Lens Material	Lens Color	Mount/Trim Color	Volts	Amps Major/Minor	Kit Includes/Replacement Parts
60302Y	Hardwired	Hardwired	Stripped End/Ring Terminal	PC	Yellow	Black	12	2.1 / 0.48	60781 light, 99011Y lens

(KIT)

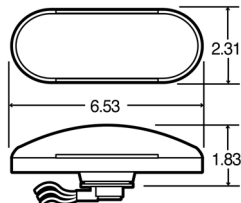

**60[®] SERIES, INCANDESCENT,
2"X 6" OVAL, GROMMET MOUNT, KIT**

FEATURES

- Socket assembly cams-out for ease in bulb replacement
- Mounts horizontally or vertically
- Upgrade to Truck-Lite LED Lighting Systems using Super 66 or 60 Series LED products



Part Number	Lamp Connection	Plug Side 1	Plug Side 2	Lens Material	Lens Color	Mount/Trim Color	Volts	Amps Major/Minor	Kit Includes/Replacement Parts
60340Y	Socket Assembly	Socket Assembly	Stripped End/Ring Terminal	PC	Yellow	Black	12	2.1 / 0.48	99184Y light, 95407 plug, 60700 grommet

(KIT)

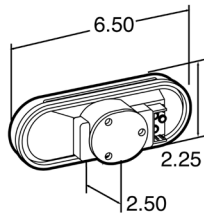

**SUPER 60[®], INCANDESCENT,
2"X 6" OVAL, GROMMET MOUNT**

FEATURES

- Mount horizontally or vertically
- Right angle plug assembly
- Upgrade to Truck-Lite LED lighting systems using Super 66 or 60 Series LED products



Part Number	Lamp Connection	Plug Side 1	Plug Side 2	Lens Material	Lens Color	Mount/Trim Color	Volts	Amps Major/Minor	Kit Includes/Replacement Parts
60202Y	PL-3	-	-	PC	Yellow	Black	12	2.1 / 0.48	-
60002Y	PL-3	Right Angle PL-3	Stripped End/Ring Terminal	PC	Yellow	Black	12	2.1 / 0.48	60202Y light, 94993 plug, 60700 grommet
60207Y	PL-3	-	-	PC	Yellow	Black	24	0.93 / 0.34	-

(KIT)

**60[®] ECONOMY, INCANDESCENT,
2"X 6" OVAL, GROMMET MOUNT**



FEATURES

- Mount horizontally or vertically
- Contains a heavy-duty, dual filament bulb
- Upgrade to Truck-Lite LED lighting systems using Super 66 or 60 Series LED products

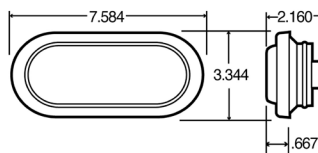

Part Number	Lamp Connection	Plug Side 1	Plug Side 2	Lens Material	Lens Color	Mount/ Trim Color	Volts	Amps Major/Minor	Kit Includes/ Replacement Parts
60283Y	PL-3	-	-	PC	Yellow	Black	12	2.1 / 0.48	-

**SUPER 45[®], INCANDESCENT,
3"X 5" RECTANGULAR, GROMMET MOUNT**



FEATURES

- Mount horizontally or vertically
- Heavy-duty, dual-filament cartridge bulb
- Unique shock mount absorbs shock and vibration
- Upgrade to LED lighting systems using Truck-Lite's Super 45 LED series product line

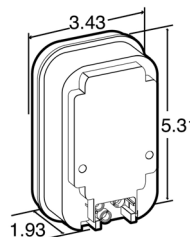

Part Number	Lamp Connection	Plug Side 1	Plug Side 2	Lens Material	Lens Color	Mount/ Trim Color	Volts	Amps Major/Minor	Kit Includes/ Replacement Parts
45202Y	PL-3	-	-	PC	Yellow	Black	12	2.16 / 0.47	-
45002Y	PL-3	Right Angle PL-3	Stripped End/Ring Terminal	PC	Yellow	Black	12	2.16 / 0.47	45202Y light, 94993 plug, 45700 grommet

(KIT)

**INCANDESCENT, 4"X 6"
RECTANGULAR, 4 SCREW MOUNT**



FEATURES

- Watertight lamp mates with Packard connector
- Recess mounts using two screws at 30" centers and two screws at 42" centers
- 12V lamps mate with PE Connector 62884715

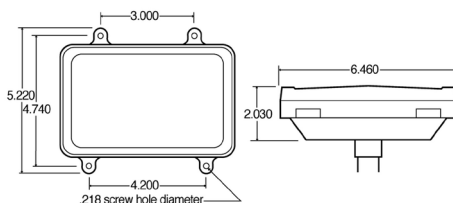

Part Number	Lamp Connection	Lens Material	Lens Color	Mount/ Trim Color	Volts	Amps Major/Minor
07080	Packard Connector 6288471	PC	Yellow	Yellow	12	2.1 / 0.48

INCANDESCENT

60 ECONOMY

INCANDESCENT

45 SERIES

INCANDESCENT

4 IN X 6 IN

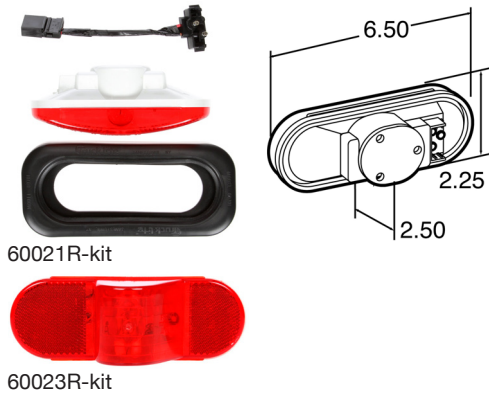

60[®] SERIES, INCANDESCENT, 2"X6", GROMMET MOUNT, KIT

FEATURES

- Direct replacement for approved lamps on the United States Postal Service L.L.V (Long Life Vehicles)
- Features a heavy-duty shock-mounted bulb
- Four versions, each features center high mount stop functions, park and turn functions, rear side marker and turn functions, or front side marker and turn signal functions



Part Number	Lamp Connector	Plug Side 1	Plug Side 2	Lens Color	Lens Material	Volts	Amps Major/Minor	Reflectorized	Kit Includes/ Replacement Parts
60021R	PL-2	Right Angle PL-2	Packard Connector 12020398	Red	PC	12	1.44	No	60213R lamp, 60701 grommet, 94838 plug (KIT)
60023R	PL-2	Right Angle PL-2	Packard Connector 12015793	Red	PC	12	2.1/0.48	Yes	60215R signal 60701 grommet, 94851 plug (KIT)
60024Y	PL-3	Right Angle PL-3	Weather Connector 12015793	Yellow	PC	12	2.1/0.48	Yes	60215Y signal 60701 grommet, 94840 plug (KIT)

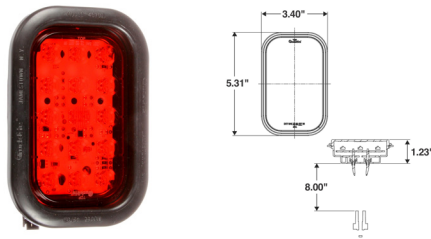

45[®] SERIES, LED, 15 DIODES, 3"X5", GROMMET MOUNT, KIT

FEATURES

- Direct replacement for approved lamps on the United States Postal Service L.L.V.
- Designed for mounting on a 7 - 11 degree rollback from the vertical plane
- Vertical-mount only



Part Number	Lamp Connector	Plug Side 1	Plug Side 2	Lens Color	Lens Material	Mount Color	Volts	Amps Major/Minor	Kit Includes
45032R	Hardwired	Hardwired	Packard Connector 12015793	Red	PC	Black	12	0.5/0.04	45701 grommet, 45372R lamp (KIT)

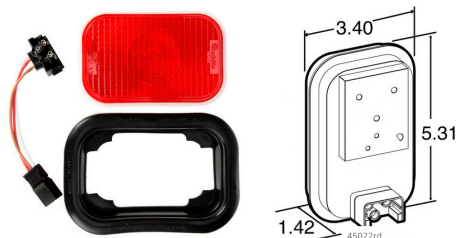

45[®] SERIES, REFLECTORIZED 3"X5", GROMMET MOUNT, INCANDESCENT, KIT

FEATURES

- Direct replacement for approved lamps on the United States Postal Service L.L.V.
- Designed for mounting on a 7 - 11 degree rollback from the vertical plane
- Vertical-mount only



Part Number	Lamp Connector	Plug Side 1	Plug Side 2	Lens Color	Lens Material	Mount Color	Volts	Amps Major/Minor	Kit Includes
45022R	PL-3	Right Angle PL-3	Packard Connector	Red	PC	Black	12	0.5/0.48	45701 grommet, 45222R lamp, 94841 pigtail (KIT)

LED

SINGLE FACE

SINGLE FACE, LED, 24 DIODE , 3 WIRES, ROUND, 1 STUD MOUNT



FEATURES

- Chrome plated housing
- Ideal for show trucks, highway, mowing, municipal and farm equipment

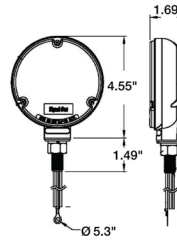

Part Number	Lamp Connector	Plug Side 1	Plug Side 2	Lens Color	Housing Material	Housing Color	Volts	Amps Major/Minor
2751	Hardwired	Hardwired	Stripped End Ring Terminal	Red	Zinc	Chrome	12	0.24/0.01
2751A	Hardwired	Hardwired	Stripped End Ring Terminal	Yellow	Zinc	Chrome	12	0.36/0.03
80867	Hardwired	Hardwired	Packard Connector	Yellow	Zinc	Black	12	0.36/0.03

INCANDESCENT

SINGLE FACE

SINGLE FACE, INCANDESCENT, 1 WIRE, ROUND, 1 STUD MOUNT



FEATURES

- For applications with vehicle width under 80" wide
- One-wire, signal lamp
- LED upgrade options available #2751, 2751A and 2750

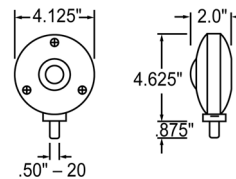

Part Number	Lamp Connector	Plug Side 1	Plug Side 2	Lens Color	Housing Material	Housing Color	Volts	Amps Major/Minor
2701	Hardwired	Hardwired	Stripped End	Red	Zinc	Black	12	2.1
2701A	Hardwired	Hardwired	Stripped End	Yellow	Zinc	Black	12	2.1
3701	Hardwired	Hardwired	Stripped End	Red	Zinc	Gray	12	2.1
3711	Hardwired	Hardwired	Stripped End	Red	Zinc	Chrome	12	2.1

INCANDESCENT

SINGLE FACE

SINGLE FACE, INCANDESCENT, 2 WIRE, ROUND, 1 STUD MOUNT, SHOCK MOUNT



FEATURES

- For vehicle application with vehicle width under 80" wide
- Two-wire, stop, tail, turn lamp
- Mounts on a 1/2"-20 stud
- Zinc die-cast housing

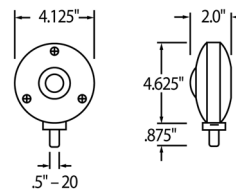

Part Number	Lamp Connector	Plug Side 1	Plug Side 2	Lens Color	Housing Material	Housing Color	Volts	Amps Major/Minor
3710	Hardwired	Hardwired	Stripped End	Red	Zinc	Gray	12	2.1/0.59

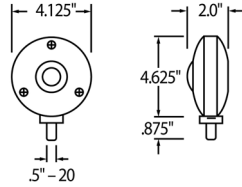

**SINGLE FACE, INCANDESCENT,
2 WIRE, ROUND, 1 STUD MOUNT**

FEATURES

- Two-wire, stop, tail, turn lamp
- Mounts on a 1/2"-20 stud
- Rubber O-ring seals out dirt and moisture
- Snap-on lens for easy bulb replacement
- LED upgrade options available #2751/2751A



Part Number	Lamp Connector	Plug Side 1	Plug Side 2	Lens Color	Housing Material	Housing Color	Volts	Amps Major/Minor
2702	Hardwired	Hardwired	Stripped End	Red	Zinc	Black	12	2.1/0.59
2702A	Hardwired	Hardwired	Stripped End	Yellow	Zinc	Black	12	2.1/0.59
3702	Hardwired	Hardwired	Stripped End	Red	Zinc	Gray	12	2.1/0.59
3712	Hardwired	Hardwired	Stripped End	Red	Zinc	Chrome	12	2.1/0.59

INCANDESCENT

SINGLE FACE

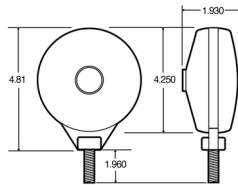

**SINGLE FACE, INCANDESCENT,
1 WIRE, ROUND, 1 STUD MOUNT**

FEATURES

- Available as single or dual-face lamps
- Single-face lamp mounts on a 7/16" -14 stud
- Features snap-in lens
- LED upgrade options available #2751, 2751A and 2750
- 3755/A mount on a 1/2"-20 stud
- 70330R/Y mount on a 7/16" stud



Part Number	Lamp Connector	Plug Side 1	Plug Side 2	Lens Color	Housing Material	Housing Color	Volts	Amps Major/Minor
3755	Hardwired	Hardwired	Stripped End	Red	PC	Black	12	2.1
3755A	Hardwired	Hardwired	Stripped End	Yellow	PC	Black	12	2.1
70330R	Hardwired	Hardwired	Blunt Cut	Red	PC	Gray	12	2.1
70330Y	Hardwired	Hardwired	Blunt Cut	Yellow	PC	Gray	12	2.1

INCANDESCENT

SINGLE FACE

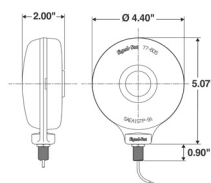

**SINGLE FACE, INCANDESCENT,
1 WIRE, ROUND,
1 STUD MOUNT, SNAP ON LENS**

FEATURES

- Available as single or dual-face lamps
- Single-face lamp mounts on a 7/16" -14 stud
- Features snap-in lens
- LED upgrade options available #2751, 2751A and 2750



Part Number	Lamp Connector	Plug Side 1	Plug Side 2	Lens Color	Housing Material	Housing Color	Volts	Amps Major/Minor
3753	Hardwired	Hardwired	Stripped End	Red	PC	White	12	2.1
3753A	Hardwired	Hardwired	Stripped End	Yellow	PC	White	12	2.1

INCANDESCENT

SINGLE FACE

**SINGLE FACE, INCANDESCENT,
2 WIRE, ROUND, 1 STUD MOUNT**



FEATURES

- Snap-on lens simplifies bulb and lens replacement
- Tough polycarbonate housing prevents rust and corrosion
- 70310R mounts on a 7/16" stud, 3756, 3754 mount on a 1/2"-20 stud
- LED upgrade Options Available: 2751, 2751A and 2750

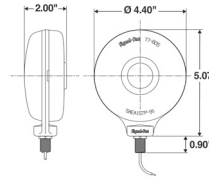

Part Number	Lamp Connector	Plug Side 1	Plug Side 2	Lens Color	Housing Material	Housing Color	Volts	Amps Major/Minor
70310R	Hardwired	Hardwired	Blunt Cut	Red	PC	Gray	12	2.1/0.59
3756	Hardwired	Hardwired	Stripped End	Red	PC	Black	12	2.1/0.59
3754	Hardwired	Hardwired	Stripped End Ring Terminal	Red	PC	White	12	2.1/0.59

**SINGLE FACE, INCANDESCENT,
SQUARE, BRACKET MOUNT, KIT**



FEATURES

- Replaces GM #694627 (LH) and #694628 (RH)
- Combination park, turn, side marker and reflex reflector
- Mounting hardware included
- Mounts on 3.20" centers and connects with 2 spade terminals
- Unique GM harness connector (harness not available from Truck-Lite)

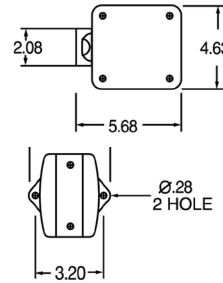

Part Number	Position	Lamp Connector	Lens Color	Housing Material	Housing Color	Volts	Amps Major/Minor	Kit Includes/ Replacement Parts	
4854	RH	Spade Terminal	Red Yellow	ABS	Black	12	2.1/0.5	9063 lens, 9078A lens, 9080A lens	(KIT)
4855	LH	Spade Terminal	Red Yellow	ABS	Black	12	2.1/0.5	9063 lens, 9078A lens, 9080A lens	(KIT)

INCANDESCENT

SINGLE FACE

INCANDESCENT

SINGLE FACE

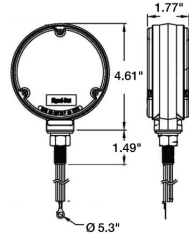

**DUAL FACE, LED, 24 DIODE,
3 WIRES, ROUND, 1 STUD MOUNT**

FEATURES

- Ideal for show trucks, highway, mowing, municipal and farm equipment
- Chrome-plated housing
- Mounts on a 1/2"-20 stud



Part Number	Lamp Connector	Plug Side 1	Plug Side 2	Lens Color	Housing Material	Housing Color	Volts	Amps Major/Minor
2750	Hardwired	Hardwired	Stripped End/Ring Terminal	Red Yellow	Zinc	Chrome	12	0.73/0.05

LED

DUAL FACE

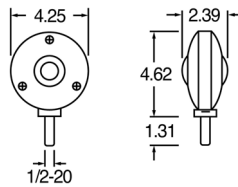

**DUAL FACE, INCANDESCENT,
1 WIRE, ROUND, 1 STUD MOUNT**

FEATURES

- For vehicle application with vehicle width under 80" wide
- Pigtail with spring and thermoplastic wire exits via hollow stud
- LED upgrade options available: 2751, 2751A and 2750



Part Number	Lamp Connector	Plug Side 1	Plug Side 2	Lens Color	Housing Material	Housing Color	Volts	Amps Major/Minor	Lens Type
2801	Hardwired	Hardwired	Stripped End	Red Yellow	Zinc	Black	12	2.1	3-Screw
3801	Hardwired	Hardwired	Stripped End	Red Yellow	Zinc	Gray	12	2.1	3-Screw
3802	Hardwired	Hardwired	Stripped End	Red Yellow	Zinc	Chrome	12	2.1	3-Screw
3860	Hardwired	Hardwired	Stripped End	Red Yellow	Zinc	Gray	12	2.1	0-Ring

INCANDESCENT

DUAL FACE

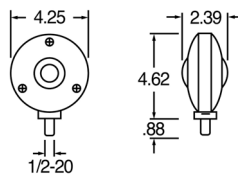

**DUAL FACE, INCANDESCENT,
1 WIRE, ROUND, 1 STUD MOUNT, SHOCK MOUNT**

FEATURES

- For vehicle application with vehicle width under 80" wide
- Pigtail with spring and thermoplastic wire exits via hollow stud
- LED upgrade options available: 2751, 2751A and 2750



Part Number	Lamp Connector	Plug Side 1	Plug Side 2	Lens Color	Housing Material	Housing Color	Volts	Amps Major/Minor
3806	Hardwired	Hardwired	Stripped End	Red Yellow	Zinc	Chrome	12	2.1

INCANDESCENT

DUAL FACE

INCANDESCENT

DUAL FACE

**DUAL FACE, INCANDESCENT,
1 WIRE, ROUND, 1 STUD MOUNT,
O-RING LENS GASKET**



FEATURES

- Snap-Grip lens allows quick bulb and lens replacement
- O-ring lens gasket seals out dirt and moisture
- Mounting: Hollow stud, 1/2" diameter

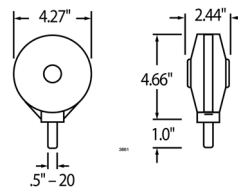

Part Number	Lamp Connector	Plug Side 1	Plug Side 2	Lens Color	Housing Material	Housing Color	Volts	Amps Major/Minor
3861	Hardwired	Hardwired	Stripped End	Red Yellow	Zinc	Chrome	12	2.1

INCANDESCENT

DUAL FACE

**DUAL FACE, INCANDESCENT,
1 WIRE, ROUND, 1 STUD MOUNT**



FEATURES

- High-impact black polycarbonate housing will not rust or corrode
- Lamp grounds through mounting stud
- Snap-grip lens simplifies bulb and lens replacement
- LED upgrade options available: 2751, 2751A and 2750

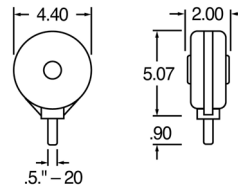

Part Number	Lamp Connector	Plug Side 1	Plug Side 2	Lens Color	Housing Material	Number of Bulbs	Housing Color	Volts	Amps Major/Minor
3850	Hardwired	Hardwired	Stripped End	Red Yellow	PC	1	Black	12	2.1
3850AA	Hardwired	Hardwired	Stripped End	Yellow	PC	1	Black	12	2.1
70300	Hardwired	Hardwired	Stripped End	Red Yellow	PC	1	White	12	2.1

INCANDESCENT

DUAL FACE

**DUAL FACE, INCANDESCENT,
2 WIRE, ROUND, 1 STUD MOUNT**



FEATURES

- Snap-Grip lens allows quick bulb and lens replacement
- O-ring lens gasket seals out dirt and moisture
- Mounting: Hollow stud, 1/2" diameter

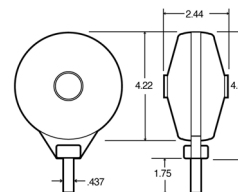

Part Number	Lamp Connector	Plug Side 1	Plug Side 2	Lens Color	Housing Material	Housing Color	Volts	Amps Major/Minor
70311	Hardwired	Hardwired	Blunt Cut	Red Yellow	PC	Yellow	12	2.1/0.59

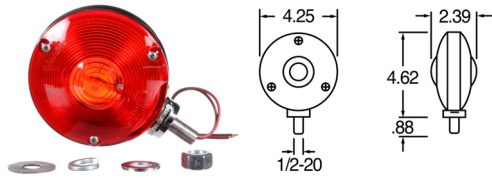

**DUAL FACE, INCANDESCENT,
2 WIRE, ROUND, 1 STUD MOUNT**

FEATURES

- 3805Y115 requires Phillips #28S 11/4SC or GE #13655 bulb
- For vehicle application with vehicle width under 80" wide
- Pigtail with spring and thermoplastic wire exits via hollow stud
- LED upgrade options available: 2751, 2751A and 2750
- #3862 has a ground wire for vehicles with fibreglass fenders; single major function only



Part Number	Lamp Connector	Plug Side 1	Plug Side 2	Lens Color	Housing Material	Housing Color	Volts	Amps Major/Minor
2803	Hardwired	Hardwired	Stripped End	Red Yellow	Zinc	Black	12	2.1/0.59
3805Y115	Hardwired	Hardwired	Stripped End	Red	Zinc	Gray	12	2.1/0.59
3812	Hardwired	Hardwired	Stripped End	Red Yellow	Zinc	Chrome	12	2.1/0.59
3862	Hardwired	Hardwired	Stripped End	Red Yellow	Zinc	Gray	12	2.1/0.59
3863	Hardwired	Hardwired	Stripped End	Red Yellow	Zinc	Gray	12	2.1/0.59

INCANDESCENT

DUAL FACE

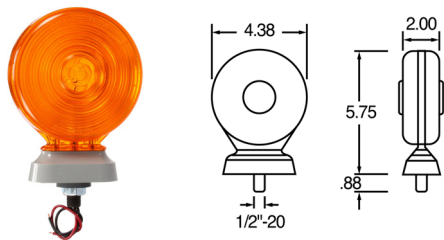

**DUAL FACE, INCANDESCENT,
2 WIRE, ROUND, 1 STUD MOUNT, KNOCK DOWN**

FEATURES

- Ideal for highway mowing, municipal lawn, and farm equipment
- Spring-loaded "Knock-Down" feature allows lamp to flex under impact and return to original position
- Meets SAE J974 for agricultural warning devices



Part Number	Lamp Connector	Plug Side 1	Plug Side 2	Lens Color	Housing Material	Housing Color	Volts	Amps Major/Minor
3853AA	Hardwired	Hardwired	Stripped End	Yellow	PC	Grey	12	2.1/0.59

INCANDESCENT

DUAL FACE

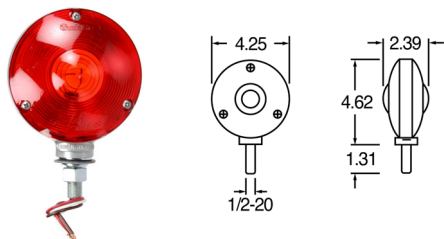

**DUAL FACE, INCANDESCENT,
3 WIRE, ROUND, 1 STUD MOUNT**

FEATURES

- For vehicle application with vehicle width under 80" wide
- Pigtail with spring and thermoplastic wire exits via hollow stud
- LED upgrade options available: 2751, 2751A and 2750



Part Number	Lamp Connector	Plug Side 1	Plug Side 2	Lens Color	Number of Bulbs	Housing Color	Volts	Amps Major/Minor
3810	Hardwired	Hardwired	Stripped End	Red Yellow	1	Chrome	12	2.1

INCANDESCENT

DUAL FACE

INCANDESCENT

DUAL FACE

**DUAL FACE, INCANDESCENT,
3 WIRE, ROUND, 1 STUD MOUNT, KNOCK DOWN**



FEATURES

- Ideal for highway mowing, municipal lawn, and farm equipment
- Spring-loaded "Knock-Down" feature allows lamp to flex under impact and return to original position
- Meets SAE J974 for agricultural warning devices

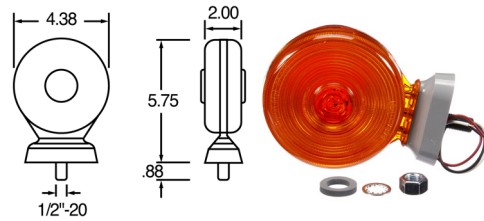

Part Number	Lamp Connector	Plug Side 1	Plug Side 2	Lens Color	Housing Material	Number of Bulbs	Housing Color	Volts	Amps Major/Minor
3854	Hardwired	Hardwired	Stripped End	Red Yellow	PC	1	Grey	12	2.1/0.59

INCANDESCENT

DUAL FACE

**DUAL FACE, INCANDESCENT,
ABS, 4 WIRE, ROUND, 2 STUD MOUNT,**



FEATURES

- Combination park, turn, side marker and reflex reflector
- Four wire design with ground wire for all applications
- High-impact ABS housing
- Includes snap-grip lens|Reverse lenses to fit left or right side

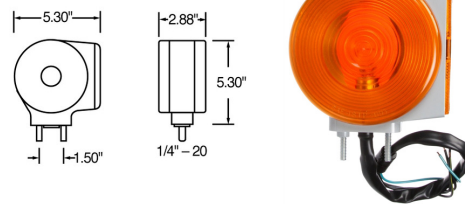

Part Number	Lamp Connector	Plug Side 1	Plug Side 2	Lens Color	Number of Bulbs	Housing Color	Volts	Amps Major/Minor
4710	Hardwired	Hardwired	Stripped End	Red Yellow	2	Grey	12	2.1/0.59

LED

DUAL FACE

**DUAL FACE, LED,
2 WIRES, SQUARE, 1 STUD MOUNT**



FEATURES

- Unique LED array displays full pattern output
- Side marker reflex reflector
- LEDs do not have a filament, therefore are not susceptible to damage from shock and vibration
- LEDs have less current draw
- Chrome-plated housing
- Meets SAE J974 for agricultural warning devices
- Epoxy encapsulated electronics protect the lamp from damage caused by chemicals and moisture

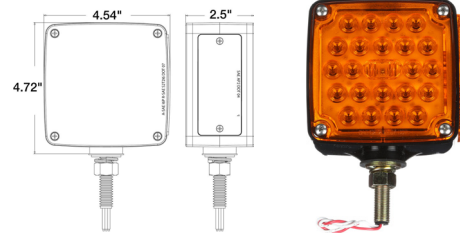

Part Number	Lamp Connector	Plug Side 1	Plug Side 2	Lens Color	Housing Material	Housing Color	Volts	Amps Major/Minor
2752	Hardwired	Hardwired	Stripped End/Ring Terminal	Yellow	ABS	Chrome	12	0.45

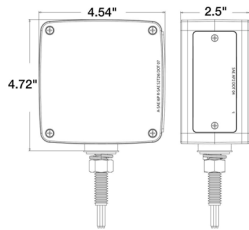

**DUAL FACE, LED,
3 WIRES, SQUARE, 1 STUD MOUNT**

FEATURES

- Unique LED array displays full pattern output
- Side marker reflex reflector
- LEDs do not have a filament, therefore are not susceptible to damage from shock and vibration
- LEDs have less current draw
- Mounts on a 1/2"-20 stud
- Chrome plated housing
- Meets SAE J974 for agricultural warning devices
- Epoxy-encapsulated electronics protect the lamp from damage caused by chemicals and moisture



Part Number	Position	Lamp Connector	Plug Side 1	Plug Side 2	Lens Color	Housing Material	Housing Color	Volts	Amps Major/Minor
2753	LH	Hardwired	Hardwired	Stripped End/Ring Terminal	Red Yellow	Zinc	Chrome	12	0.38/0.04
2756	RH	Hardwired	Hardwired	Stripped End/Ring Terminal	Red Yellow	Zinc	Chrome	12	0.38/0.04

LED

DUAL FACE

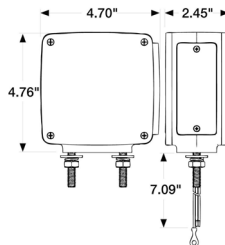

**DUAL FACE, LED, 24 DIODE,
3 WIRES, SQUARE, 2 STUD MOUNT**

FEATURES

- Ideal for show trucks, highway, mowing, municipal and farm equipment
- Mounts on 2 of 5/16"-20 stud on 2" centers
- Unique LED array displays full pattern output
- Side marker reflex reflector
- LEDs do not have a filament, therefore are not susceptible to damage from shock and vibration
- LEDs have less current draw, resulting in increased battery and alternator life while allowing more power for other vehicle requirements
- Epoxy-encapsulated electronics protect the lamp from damage caused by chemicals and moisture
- Double-stud mount



Part Number	Position	Lamp Connector	Plug Side 1	Plug Side 2	Lens Color	Housing Material	Housing Color	Volts	Amps Major/Minor
2758	RH	Hardwired	Hardwired	Stripped End/Ring Terminal	Red Yellow	Zinc	Chrome	12	0.38/0.04
2759	LH	Hardwired	Hardwired	Stripped End/Ring Terminal	Red Yellow	Zinc	Chrome	12	0.38/0.04

LED

DUAL FACE

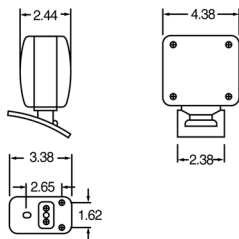

**DUAL FACE, INCANDESCENT,
1 WIRE, SQUARE, SURFACE MOUNT**

FEATURES

- Blade-type connector
- Die-cast base assembly
- Dual-optic lenses
- Mounting bracket included



Part Number	Lamp Connector	Plug Side 1	Plug Side 2	Lens Color	Number of Bulbs	Housing Material	Housing Color	Volts	Amps Major/Minor
950	Hardwired	Hardwired	Packard Connector	Red Yellow	1	Zinc	Chrome	12	2.1

INCANDESCENT

DUAL FACE

INCANDESCENT

DUAL FACE

DUAL FACE, INCANDESCENT, SQUARE, BRACKET MOUNT, KIT



FEATURES

- GM #2029217
- Combination park, turn, side marker, and reflex reflector
- Mounts on 3.25" centers and connects with 3 spade terminals
- Fits left or right side
- Unique GM harness connector (harness not available from Truck-Lite)

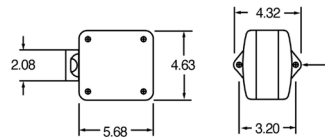

Part Number	Lamp Connector	Lens Color	Number of Bulbs	Mount Material	Mount Color	Volts	Amps Major/Minor	Kit Includes
4872AA	Spade Terminal	Yellow	1	PC	Black	12	2.1/0.5	9083A lens



INCANDESCENT

DUAL FACE

DUAL FACE, INCANDESCENT, 2 WIRE, SQUARE, BRACKET MOUNT, KIT



FEATURES

- Die-cast base assembly
- Receptacle type connector
- Mounting bracket included
- 956AA Navistar #582779C91
- 957AA Navistar #582780C91

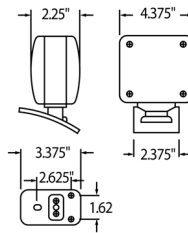

Part Number	Lamp Connector	Plug Side 1	Plug Side 2	Lens Color	Number of Bulbs	Mount Material	Mount Color	Volts	Amps Major/Minor	Kit Includes
956AA	Hardwired	Hardwired	Female .180 Bullet	Yellow	1	Zinc	Chrome	12	2.1/0.5	8960 lens, 8960A lens
957AA	Hardwired	Hardwired	.180 Bullet/ Female .180 Bullet	Yellow	1	Zinc	Chrome	12	2.1/0.5	8960 lens, 8960A lens



INCANDESCENT

DUAL FACE

DUAL FACE, INCANDESCENT, 1 WIRE, SQUARE, 1 STUD MOUNT



FEATURES

- Dual-optic lenses
- Die-cast base assembly
- Mounts left or right, horizontally or vertically
- Mounting hardware for stud or pedestal installation

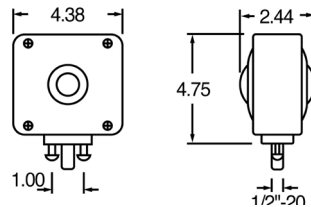

Part Number	Lamp Connector	Plug Side 1	Plug Side 2	Lens Color	Housing Material	Housing Color	Volts	Amps Major/Minor
955	Hardwired	Hardwired	Stripped End	Red Yellow	Zinc	Black	12	2.1/0.5

**DUAL FACE, INCANDESCENT,
2 WIRE, SQUARE, 1 STUD MOUNT**

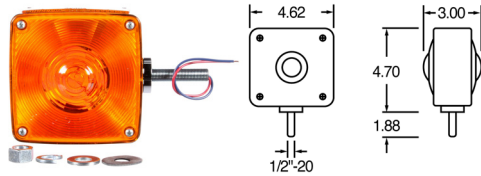

FEATURES

- Black-housed version is a popular Western Star replacement
- Chrome-housed version is a popular replacement for Volvo and Peterbilt
- Combination park, turn, side marker and reflex reflector
- Standard on many OEM applications
- High-impact non-corrosive polycarbonate housing
- Side marker and reflector included in design
- 4800/4801 mount vertically
- 4810 mount horizontally (GM# 677914)



Part Number	Lamp Connector	Plug Side 1	Plug Side 2	Lens Color	Number of Bulbs	Mount Material	Housing Color	Volts	Amps Major/Minor
4800	Hardwired	Hardwired	Stripped End	Red Yellow	2	PC	Black	12	2.1/0.5
4801	Hardwired	Hardwired	Stripped End	Red Yellow	2	PC	Chrome	12	2.1/0.5
4810	Hardwired	Hardwired	Stripped End	Red Yellow	2	PC	Black	12	2.1/0.5

INCANDESCENT

DUAL FACE

**DUAL FACE, INCANDESCENT,
3 WIRE, SQUARE, 2 STUD MOUNT**

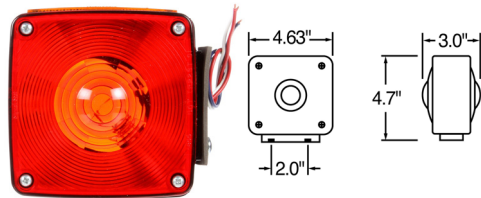

FEATURES

- Ground wire added for use on fiberglass fenders
- High-impact non-corrosive polycarbonate housing
- Mounting pad and two 1/4"-20 bolts included
- Side marker and reflector included in design



Part Number	Lamp Connector	Plug Side 1	Plug Side 2	Lens Color	Number of Bulbs	Mount Material	Housing Color	Volts	Amps Major/Minor
4805	Hardwired	Hardwired	Stripped End	Red Yellow	2	PC	Black	12	2.1/0.5

INCANDESCENT

DUAL FACE

**DUAL FACE, INCANDESCENT,
3 WIRE, SQUARE, 2 STUD MOUNT, ABS**

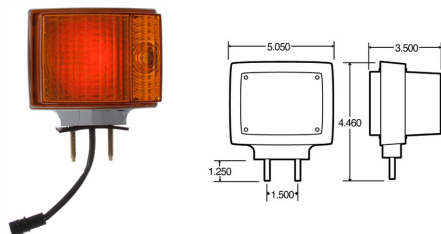

FEATURES

- Replaces Ford parts E5HT-13200-AA (RH) and E5HT-13200-AA RH0
- Contains one bulb for turn signal functions and one bulb for marker and park functions
- Includes integral plug



Part Number	Position	Lamp Connector	Plug Side 2	Lens Color	Number of Bulbs	Mount Material	Housing Color	Volts	Amps Major/Minor
70352	LH	Hardwired	Integral Plug	Red Yellow	2	PC	Chrome	12	2.1/0.5
70353	RH	Hardwired	Integral Plug	Red Yellow	2	PC	Chrome	12	2.1/0.5
70356	LH	Hardwired	Integral Plug	Red Yellow	2	PC	Black	12	2.1/0.5
70357	RH	Hardwired	Integral Plug	Red Yellow	2	PC	Black	12	2.1/0.5

INCANDESCENT

DUAL FACE

INCANDESCENT

DUAL FACE

**DUAL FACE, INCANDESCENT,
2 WIRE, RECTANGULAR, 2 STUD MOUNT**



FEATURES

- Combination lamp functions as turn signal, side marker and parking lamp with reflector
- High-impact plastic housing resists rust and corrosion
- Wire harness enclosed in weather proof housing
- 4742 flat surface vertical mount
- 4754 flat surface horizontal mount

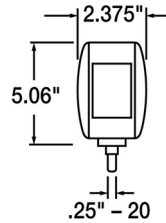
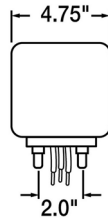

Part Number	Lamp Connector	Plug Side 1	Plug Side 2	Lens Color	Number of Bulb	Mount Material	Housing Color	Volts	Amps Major/Minor
4742	Hardwired	Hardwired	Stripped End	Red Yellow	2	ABS	Black	12	2.1/0.5
4754	Hardwired	Hardwired	Stripped End	Red Yellow	2	ABS	Black	12	2.1/0.5

INCANDESCENT

DUAL FACE

**DUAL FACE, INCANDESCENT,
3 WIRE, RECTANGULAR, 2 STUD MOUNT**



FEATURES

- Functions as turn signal, parking and side marker lamp, with reflector
- ABS housing will not rust or corrode
- Shock/Mount bulb socket
- Includes separate ground wire for installation
- Fits right and left side applications

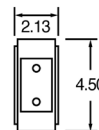
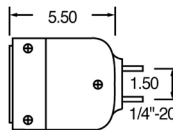

Part Number	Lamp Connector	Plug Side 1	Plug Side 2	Lens Color	Number of Bulbs	Mount Material	Housing Color	Volts	Amps Major/Minor
4701	Hardwired	Hardwired	Stripped End	Red Yellow	2	PC	Chrome	12	2.1/0.5
4702	Hardwired	Hardwired	Stripped End	Red Yellow	2	PC	Black	12	2.1/0.5

**DUAL FACE, INCANDESCENT,
3 WIRE, RECTANGULAR, 2 STUD MOUNT**

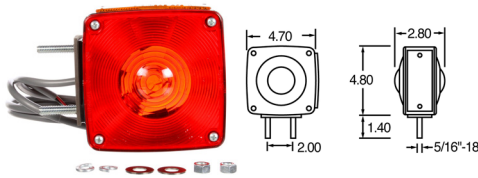

FEATURES

- 4805AAY115 includes OEM 7" harness that mates with truck harness - simplifying replacement
- 4805AAY118 included 75" OEM mating harness
- Dual-optic lens
- Polycarbonate lens and housing
- Mount vertically
- Side marker and reflector included in design
- Mounting pad included
- Two 5/16" studs on 2" centers
- 4805AAY115, Freightliner #681-822-0020
- 4805AAY118, Freightliner #681-822-0120
- 4805AY116, Freightliner #A06-18900-00 (LH)
- 4805AY117, Freightliner #A06-18900-01 (RH)
- 4874AY101 Kenworth #K-256-D-324



Part Number	Position	Lamp Connector	Plug Side 1	Plug Side 2	Lens Color	Number of Bulbs	Mount Material	Housing Color	Volts	Amps Major/Minor
4805AAY115	-	Hardwired	Hardwired	Packard 12010996 Packard 12010973	Yellow	2	PC	Black	12	2.1/0.5
4805AAY118	-	Hardwired	Hardwired	Packard 12015791/ Packard 12015792	Yellow	2	PC	Black	12	2.1/0.5
4805AY116	LH	Hardwired	Hardwired	Packard 12052457	Red/ Yellow	2	PC	Chrome	12	2.1/0.5
4805AY117	RH	Hardwired	Hardwired	Packard 12052457	Red/ Yellow	2	PC	Chrome	12	2.1/0.5
4874AY101	-	Hardwired	Hardwired	.180 Bullet/ Female .180 Bullet	Yellow	1	PC	Chrome	12	2.1/0.5

INCANDESCENT

DUAL FACE

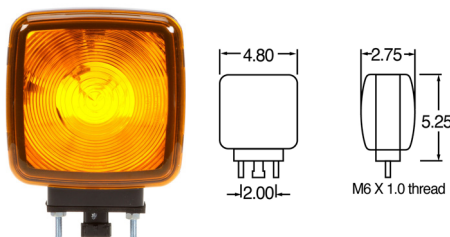

**5800 SERIES, DUAL FACE, INCANDESCENT,
3 WIRE, RECTANGULAR, 2 STUD MOUNT**

FEATURES

- Polycarbonate snap-On/snap-off lens - no screws
- Special Packard Metri-Pack connector
- Combination side marker lamp and reflex reflector lens
- Mounts left or right
- Unbreakable, easy bulb replacement one lens sealed, one lens snaps on/off
- For quick, easy connection that eliminates corrosion
- Isolates the bulb from the jarring effects of road shock and vibration
- For front turn signal, park and side marker
- Eliminates the need for separate side marker lamp and reflex reflector
- Positive lens fit, corrosion proof, watertight
- GM #1556531



Part Number	Lamp Connector	Plug Side 1	Plug Side 2	Lens Color	Number of Bulbs	Mount Material	Housing Color	Volts	Amps Major/Minor
5800AA	Packard Connector	Packard Connector	Stripped End	Yellow	1	PC	Black	12	2.1/0.59
5800AAK	Packard Connector	Packard Connector	Stripped End	Yellow	1	PC	Black	12	2.1/0.59

5800AA light, 04161 harness

INCANDESCENT

DUAL FACE

LIGHT MODULES

Lamps	Type	Page
2 Lamp		90-92
	LED, Stop/Turn/Tail	90
	LED, S/T/T Marker Clearance	90
	Stop/Turn/Tail	91
	S/T/T M/C Side-Marker	91
	S/T/T Back-Up	92
3 Lamp		92-95
	LED, S/T/T Back-Up Turn Side	92
	S/T/T Back-Up Turn Side	93
	S/T/T Back-Up Side Marker	93
	LED, S/T/T Back-Up License	94
	S/T/T Back-Up License	94
	S/T/T Back-Up	95
	S/T/T Back-Up Turn Signal	95

LED

40 SERIES

40[®] SERIES, LED, STOP/TURN/TAIL



FEATURES

- Features universal mount designed to retrofit a wide variety of vehicles
- Kits include metal mounting box with side marker lamp and reflector
- Optional mounting gasket available to provide extra seal between module and body

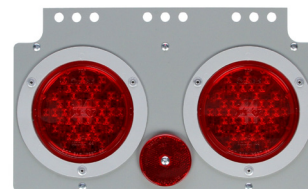
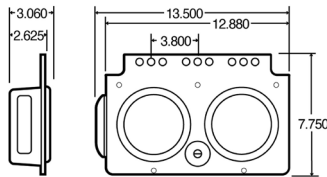

Standards Met	Compliance Family
A I6 P2 S2 T	FMVSS 108 CMVSS 108 DOT SAE

Part Number	Position	Mount/Trim Color	S/T/T Light Part#	M/C Light Part#	Volts
40626	Road Side	Gray	44222R	44222R	12
40627	Curb Side	Gray	44222R	44222R	12

LED

40 SERIES

40[®] SERIES, LED, STOP/TURN/TAIL | MARKER CLEARANCE



FEATURES

- Features universal mount designed to retrofit a wide variety of vehicles
- Kits include metal mounting box with side marker lamp and reflector
- Optional mounting gasket available to provide extra seal between module and body
- Truck-Lite or Signal-Stat LED lighting modules also available

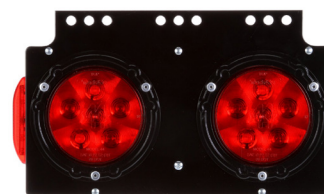
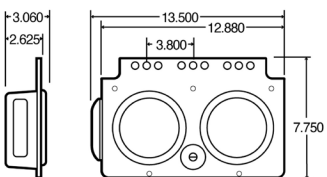

Standards Met	Compliance Family
A I6 P2 S2 T	FMVSS 108 CMVSS 108 DOT SAE

Part Number	Position	Mount/Trim Color	S/T/T Light Part#	M/C Light Part#	Volts
40637	Road Side	Black	44326R	19250R	12
40638	Curb Side	Black	44326R	19250R	12

LED

SIGNAL-STAT

SIGNAL-STAT, LED, STOP/TURN/TAIL | MARKER CLEARANCE



FEATURES

- Features universal mount designed to retrofit a wide variety of vehicles
- Kits include metal mounting box with side marker lamp and reflector
- Optional mounting gasket available to provide extra seal between module and body
- Truck-Lite or Signal-Stat LED lighting modules also available

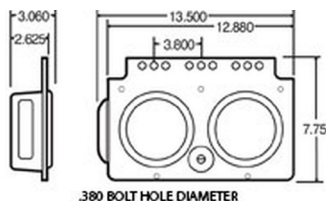

Standards Met	Compliance Family
A I6 P2 S2 T	FMVSS 108 CMVSS 108 DOT SAE

Part Number	Position	Mount/Trim Color	M/C Light Part#	S/T/T Light Part#	Grommet Part#	Volts
9536	Road Side	Black	1960	4050	40700	12
9537	Curb Side	Black	1960	4050	40700	12

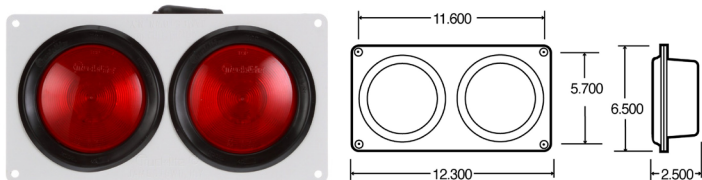

40[®] SERIES, INCANDESCENT, STOP/TURN/TAIL, PVC

FEATURES

- Features high-impact plastic module box
- Mounts in 11" x 5.12" hole
- Optional mounting gasket available to provide extra seal between module and body



Standards Met	Compliance Family
P2 S2 I6 T	FMVSS 108 CMVSS 108 DOT SAE

Part Number	Position	Mount/Trim Color	S/T/T Light Part#	Harness	Grommet	Housing	Volts
40742	Road Side	Black	40202R	50201	40700	40722	12
40743	Curb Side	Black	40202R	50200	40700	40722	12

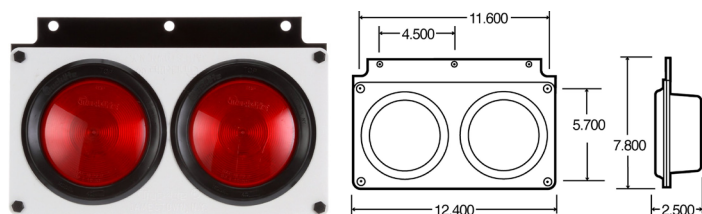

40[®] SERIES, INCANDESCENT, STOP/TURN/TAIL, STEEL

FEATURES

- Features metal mounting flange with high-impact plastic module box
- Optional mounting gasket #97938 available to provide extra seal between module and body



Standards Met	Compliance Family
S2 I6 R T	FMVSS 108 CMVSS 108 DOT SAE

Part Number	Position	Mount/Trim Color	S/T/T Light Part#	Harness	Grommet	Housing	Face Flare	Volts
40746	Road Side	Black	40202R	50201	40700	40722	40721	12
40747	Curb Side	Black	40202R	50200	40700	40722	40721	12

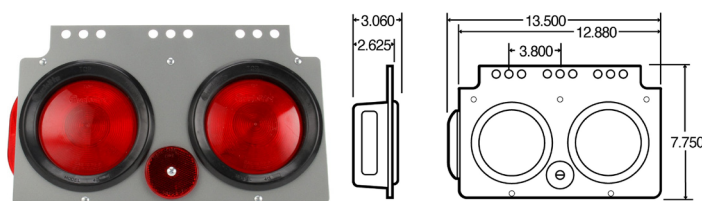

40[®] SERIES, INCANDESCENT, STOP/TURN/TAIL | MARKER CLEARANCE | SIDE MARKER

FEATURES

- Features universal mount designed to retrofit a wide variety of vehicles
- Kits include metal mounting box with side marker lamp and reflector
- Optional mounting gasket available to provide extra seal between module and body
- Truck-Lite or Signal-Stat LED lighting modules also available



Standards Met	Compliance Family
A I6 P2 S2 T	FMVSS 108 CMVSS 108 DOT SAE

Part Number	Position	Mount/Trim Color	S/T/T Light Part#	M/C Light Part#	Harness	Grommet	Volts
40756	Road Side	Black	40202R	19200R	94933, 94942	40700	12
40757	Curb Side	Black	40202R	19200R	94933, 94942	40700	12

**40[®] SERIES, INCANDESCENT,
STOP/TURN/TAIL | BACK-UP**



FEATURES

- Features high-impact plastic module box
- Mounts in 11" x 5.12" hole
- Optional mounting gasket available to provide extra seal between module and body

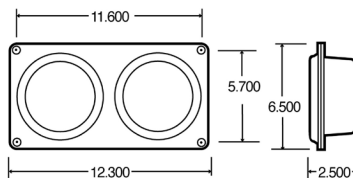

Standards Met	Compliance Family
P2 S2 I6 T	FMVSS 108 CMVSS 108 DOT SAE

Part Number	Position	Mount/Trim Color	S/T/T Light Part#	B/U Light Part#	Harness	Housing	Grommet	Volts
40748	Road Side	Black	40242R	40244	50200	40722	40700	12
40749	Curb Side	Black	40242R	40244	50201	40722	40700	12

**40[®] SERIES, INCANDESCENT,
STOP/TURN/TAIL | BACK-UP**



FEATURES

- Features metal mounting flange with high-impact plastic module box
- Optional mounting gasket #97938 available to provide extra seal between module and body

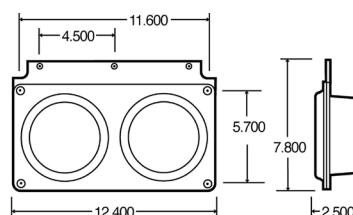

Standards Met	Compliance Family
S2 I6 R T	FMVSS 108 CMVSS 108 DOT SAE

Part Number	Position	Mount/Trim Color	S/T/T Light Part#	B/U Light Part#	Harness	Face Plate	Housing	Grommet	Volts
40754	Road Side	Black	40242R	40244	50201	40721	40722	40700	12
40755	Curb Side	Black	40242R	40244	50200	40721	40722	40700	12

**SUPER 44[®], LED,
STOP/TURN/TAIL | BACK-UP |
TURN SIGNAL | SIDE MARKER**



FEATURES

- Popular on straight truck applications
- Features metal module box with side marker and back-up lamps

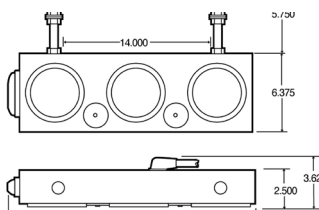

Standards Met	Compliance Family
A I6 P2 R S2 T	FMVSS 108 CMVSS 108 DOT SAE

Part Number	Position	Mount/Trim Color	S/T/T Light Part#	Turn Signal Light Part#	B/U Light Part#	M/C Light Part#	Harness	Grommet Part#	Volts
44808	Curb Side	Black	44302R	44201Y	44206C	19250R	96502	40700	12
44809	Road Side	Black	44302R	44201Y	44206C	19250R	96503	40700	12

INCANDESCENT

40 SERIES

INCANDESCENT

40 SERIES

LED

SUPER 44

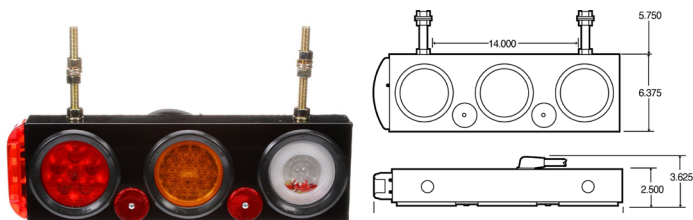

**40[®] SERIES, LED/
INCANDESCENT,
STOP/TURN/TAIL | BACK-UP |
TURN SIGNAL | SIDE MARKER**

FEATURES

- Popular on straight truck applications
- Features metal module box with side marker and back-up lamps



Standards Met	Compliance Family
A I6 P2 R S2 T	FMVSS 108 CMVSS 108 DOT SAE

Part Number	Position	Mount/Trim Color	S/T/T Light Part#	Turn Signal Light Part#	B/U Light Part#	M/C Light Part#	Grommet Part#	Volts
40808	Curb Side	Black	44302R	44201Y	40244	21201R	40700	12
40809	Road Side	Black	44302R	44201Y	40244	21201R	40700	12

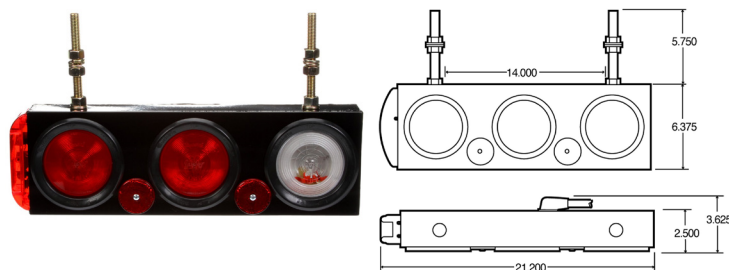

**40[®] SERIES, INCANDESCENT,
STOP/TURN/TAIL | BACK-UP |
SIDE MARKER**

FEATURES

- Popular on straight truck applications
- Features metal module box with side marker and back-up lamps



Standards Met	Compliance Family
A I6 P2 R S2 T	FMVSS 108 CMVSS 108 DOT SAE

Part Number	Position	Mount/Trim Color	S/T/T Light Part#	B/U Light Part#	M/C Light Part#	Grommet	Volts
40758	Road Side	Black	40242R	40244	21201R	40700	12
40759	Curb Side	Black	40242R	40244	21201R	40700	12

40[®] SERIES, LED, STOP/TURN/TAIL | BACK-UP | LICENSE



FEATURES

- 40894 features Peterbilt replacement with red LED lamps and excludes junction box Mounts between frame rail
- Features heavy-gauge metal module
- Comes with pre-assembled junction box with wiring harness

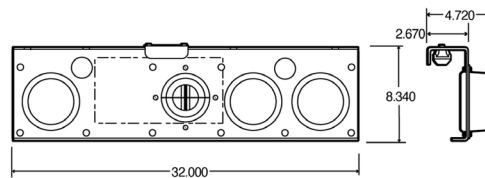

Standards Met	Compliance Family
S2 I6 A R T	FMVSS 108 CMVSS 108 DOT SAE

Part Number	Mount/Trim Color	B/U Light Part#	License Light Part#	S/T/T Light Part#	Column	Grommet Part#	Volts
40894	Black	40204	19206	44302R	95723	40700	12

40[®] SERIES, INCANDESCENT, STOP/TURN/TAIL | BACK-UP | LICENSE



FEATURES

- Mounts between frame rail
- Features heavy-gauge metal module
- Comes with pre-assembled junction box with wiring harness

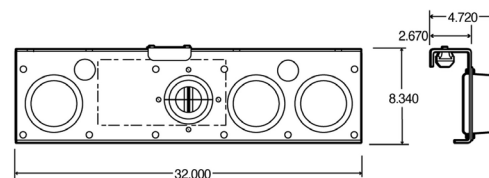

Standards Met	Compliance Family
A I6 P2 R S2 T	FMVSS 108 CMVSS 108 DOT SAE

Part Number	Mount/Trim Color	S/T/T Light Part#	B/U Light Part#	License Light Part#	Grommet	Volts
40850	Black	40242R	40204	19206	40700	12

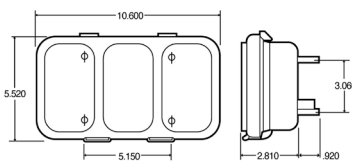

45 SERIES, INCANDESCENT, STOP/TURN/TAIL | BACK-UP

FEATURES

- Unique housing offers shock absorbency and allows lamp replacement without tools
- Features rugged thermoplastic rubber housing
- High-impact polypropylene cover
- Pre-wired terminal contact strip included



Standards Met	Compliance Family
P2 S2 I6 R A T	FMVSS 108 CMVSS 108 DOT SAE

Part Number	Position	Mount/Trim Color	S/T/T Light Part#	B/U Light Part#	Housing	Cover	Volts
45740	Road Side	Black	45202R	45204	45323	45333	12
45741	Curb Side	Black	45202R	45204	45323	45333	12

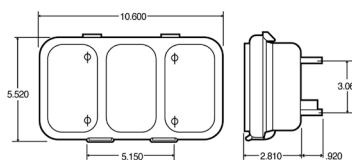

SIGNAL-STAT, INCANDESCENT, STOP/TURN/TAIL | BACK-UP | TURN SIGNAL

FEATURES

- Unique housing offers shock absorbency and allows lamp replacement without tools
- Features rugged thermoplastic rubber housing
- High-impact polypropylene cover
- Pre-wired terminal contact strip included



Standards Met	Compliance Family
P2 S2 I6 R A T	FMVSS 108 CMVSS 108 DOT SAE

Part Number	Position	Mount/Trim Color	S/T/T Light Part#	B/U Light Part#	Turn Signal Light Part#	Housing	Cover	Volts
45742	Road Side	Black	45202R	45204	45201Y	45323	45333	12
45743	Curb Side	Black	45202R	45204	45201Y	45323	45333	12

MARKER & CLEARANCE LIGHTS

Shape	Common Size	Page
ROUND		100-118
	2"	100-107
	2.5"	108-116
	0.75"	116-118
RECTANGULAR		118-145
	1 x 2"	118-123
	1 x 4"	124-129
	2 x 3"	130-132
	2 x 4"	133-136
	2 x 5"	137-140
	2 x 6"	140-145
OVAL		146-147
	1 x 4"	146
	2 x 4"	146-147
Triangular		148-150
	1 x 4"	148
	1 x 5"	148
	2 x 3"	149
	3 x 4"	149-150
	3 x 6"	150
Beehive		151-153
	1"	151
	2"	151-152
	2.5"	152-153
	4"	153







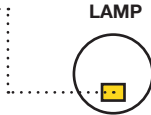
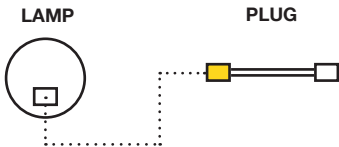
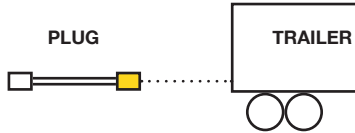





Marker/Clearance Lighting

Truck-Lite's LED marker and clearance lighting is designed to exceed legal requirements when correctly mounted. A variety of styles and mounting options allow for easy customization and provide the safety and visibility that you've come to expect from Truck-Lite.

<p>Shapes</p>	<p>Round, Oval, Rectangular, Triangular, Beehive, Winged</p>
<p>Mount Types</p>	<p>Grommet, Flange, Bracket, 2 Screw, 4 Screw, Adhesive, 2 Bolt, 1 Stud, 2 Stud</p>
<p>Connection Information</p> <p>When it comes to choosing the correct lamps for your truck or trailer, it's important to know the connection type on your vehicle's harness.</p> <p>If the harness connector type does not match your desired light (lamp connector), you will need a plug to complete the connection.</p>	<p>Lamp Connector</p> <p>The connector type located on the back of a lamp</p>  <p>Plug Side 1</p> <p>The connection between a plug and a lamp</p>  <p>Plug Side 2</p> <p>The connection between a plug and a trailer's harness</p> 

(800) 562-5012 | truck-lite.com

 <p>Manufacturing & Quality</p>	 <p>Testing & Safety</p>
<p>Truck-Lite's LED marker/clearance lighting is built using premium materials and backed by industry-leading warranties. Designed to last the life of your vehicle, Truck-Lite's solid-state construction and sealed circuitry mean that you can depend on your lighting to withstand shock, vibration, moisture and debris.</p>	<p>All Truck-Lite lamps are subjected to rigorous environmental, electrical and mechanical testing before they are validated and released to the market.</p> <p>All lamps comply with FMVSS/CMVSS-108, SAE and DOT standards when properly mounted.</p>
 <p>Performance & Maintenance</p>	 <p>Customer Support</p>
<ul style="list-style-type: none"> • Lower energy consumption, allowing more power for other vehicle requirements • Impact-resistant lenses and rugged housing protect against damage from even the toughest applications • Sealed electronics resist damage caused by moisture and corrosion • Reduced lighting costs associated with physical damage and heat entrapment 	<p>Customer Service  (800) 562-5012 customerservice@truck-lite.com</p> <p>Technical Support  (888) 562-5012 tltech@truck-lite.com</p> <p>Marker & Clearance Warranties</p> <div style="display: flex; justify-content: space-around; align-items: center;">     </div>
<p>(800) 562-5012 truck-lite.com</p>	

30[®] SERIES, GROMMET MOUNT, 2" ROUND, LED



FEATURES

- Most commonly used 2" round clearance light, with weather tight connection.
- Waterproof completely sealed electronics
- Single and bulk packs available



Part Number	Lens Color	Lamp Connector	Plug Side 1	Plug Side 2	Volts	Amps	Diodes	Lighting Codes	Kit Includes
30250R	Red	Fit 'N Forget M/C	—	—	12	0.05	2	P2 P3	—
30050R	Red	Fit 'N Forget M/C	Fit 'N Forget M/C	Female PL-10	12	0.05	2	P2 P3	30250R light, 30700 grommet, 93745 plug (KIT)
30250Y	Yellow	Fit 'N Forget M/C	—	—	12	0.05	2	P2 P3	—
30050Y	Yellow	Fit 'N Forget M/C	Fit 'N Forget M/C	Female PL-10	12	0.05	2	P2 P3	30250Y light, 30700 grommet, 93745 plug (KIT)
30255R	Red	Fit 'N Forget M/C	—	—	12 24	0.05	3	P2 P3	—
30055R	Red	Fit 'N Forget M/C	Fit 'N Forget M/C	Female PL-10	12 24	0.05	3	P2 P3	30255R light, 30700 grommet, 93745 plug (KIT)
30255Y	Yellow	Fit 'N Forget M/C	—	—	12 24	0.05	3	P2 P3	—
30055Y	Yellow	Fit 'N Forget M/C	Fit 'N Forget M/C	Female PL-10	12 24	0.05	3	P2 P3	30255Y light, 30700 grommet, 93745 plug (KIT)
30273R	Red	Fit 'N Forget M/C	—	—	12 24	0.05	3	E Mark	—
30273Y	Yellow	Fit 'N Forget M/C	—	—	12 24	0.05	3	E Mark	—

30[®] SERIES, GROMMET MOUNT, LOW-PROFILE, LED, 2" ROUND,



FEATURES

- Flush mount design protects against objects hitting and damaging the light
- Fits standard grommet
- 30385R/Y have unique lens optics allowing for SAE PC applications



Part Number	Lens Color	Lamp Connector	Plug Side 1	Plug Side 2	Volts	Amps	Diodes	Lighting Codes	Kit Includes
30270R	Red	Fit 'N Forget M/C	—	—	12	0.05	2	P2 P3	—
30070R	Red	Fit 'N Forget M/C	Fit 'N Forget M/C	Female PL-10	12	0.05	2	P2 P3	30270R light, 30700 grommet, 93745 plug (KIT)
30270Y	Yellow	Fit 'N Forget M/C	—	—	12	0.05	2	P2 P3	—
30070Y	Yellow	Fit 'N Forget M/C	Fit 'N Forget M/C	Female PL-10	12	0.05	2	P2 P3	30270Y light, 30700 grommet, 93745 plug (KIT)
30385R	Red	Fit 'N Forget M/C	—	—	12	0.12	6	P2 PC	—
30086R	Red	Fit 'N Forget M/C	Fit 'N Forget M/C	Female PL-10	12	0.12	6	P2 PC	30385R light, 30700 grommet, 93745 plug (KIT)
30385Y	Yellow	Fit 'N Forget M/C	—	—	12	0.1	6	P2 PC	—
30086Y	Yellow	Fit 'N Forget M/C	Fit 'N Forget M/C	Female PL-10	12	0.12	6	P2 PC	30385R light, 30700 grommet, 93745 plug (KIT)

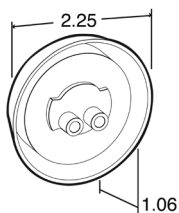

30[®] SERIES, GROMMET MOUNT, LOW-PROFILE, LED, 2" ROUND,

FEATURES

- Unique lens optics allows for SAE PC rated combination clearance/marker applications
- Has standard PL-10 connection



Part Number	Lens Color	Lamp Connector	Volts	Amps	Diodes	Lighting Codes
30285R	Red	PL-10	12	0.12	6	P2 PC
30285Y	Yellow	PL-10	12	0.12	6	P2 PC

LED
30 SERIES

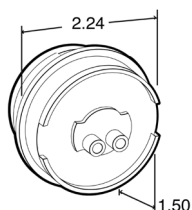

30[®] SERIES, GROMMET MOUNT, HIGH-PROFILE, LED, 2" ROUND,

FEATURES

- Dome design allows for SAE PC rated combination clearance/marker applications
- Comes in both weather tight and standard connections



30075R-kit



30085Y-kit

LED
30 SERIES

Part Number	Lens Color	Lamp Connector	Plug Side 1	Plug Side 2	Volts	Amps	Diodes	Lighting Codes	Kit Includes
30275R	Red	PL-10	—	—	12	0.1	8	P2 P3 PC	—
30075R	Red	PL-10	PL-10	.180 Bullet/Ring Terminal	12	0.1	8	P2 P3 PC	30275R light, 30700 grommet, 94964 plug
30275Y	Yellow	PL-10	—	—	12	0.1	8	P2 P3 PC	—
30075Y	Yellow	PL-10	PL-10	.180 Bullet/Ring Terminal	12	0.1	8	P2 P3 PC	30275Y light, 30700 grommet, 94964 plug
30375R	Red	Fit 'N Forget M/C	—	—	12	0.1	8	P2 P3 PC	—
30375Y	Yellow	Fit 'N Forget M/C	—	—	12	0.1	8	P2 P3 PC	—
30085R	Red	Fit 'N Forget M/C	Fit 'N Forget M/C	Female PL-10	12	0.1	8	P2 P3 PC	30375R light, 30700 grommet, 93745 plug
30085Y	Yellow	Fit 'N Forget M/C	Fit 'N Forget M/C	Female PL-10	12	0.1	8	P2 P3 PC	30375Y light, 30700 grommet, 93745 plug
30376R	Clear/Red	Fit 'N Forget M/C	—	—	12	0.1	8	P2 P3 PC	—
30376Y	Clear/Yellow	Fit 'N Forget M/C	—	—	12	0.1	8	P2 P3 PC	—
30264Y	Yellow	PL-10	—	—	12	0.1	8	ABS	—



*FEATURES FOR ALL PRODUCTS ON PAGES 102 & 103

FEATURES

- Flange is permanently affixed to lamp
- Lamp kits include one plug or harness
- Direct pin-to-circuit board solders assure vibration-resistant contacts
- Electronics completely sealed in epoxy to resist corrosion and moisture
- Low current draw, leaving more power for other vehicle requirements
- Sonically sealed lens and housing
- LEDs are less susceptible to shock and vibration
- Lamp flush mounts with a grommet or flange
- OmniVolt universal lighting products address increasing vehicle power demands by operating equally in electrical systems that range from 10 to 30 volts
- 97080 gasket available separately if required

30[®] SERIES, FLANGE MOUNT, LED, 2" ROUND



Part Number	Lens Color	Lamp Connector	Volts	Amps	Diodes	Lighting Codes
30251R	Red	Fit 'N Forget M/C	12	0.05	2	P2 P3
30251Y	Yellow	Fit 'N Forget M/C	12	0.05	2	P2 P3
30262R	Red	Fit 'N Forget M/C	12 24	0.05	1	E Mark
30262Y	Yellow	Fit 'N Forget M/C	12 24	0.05	1	E Mark
30265R	Red	Fit 'N Forget M/C	12 24	0.05	1	E Mark
30265Y	Yellow	Fit 'N Forget M/C	12 24	0.05	1	E Mark

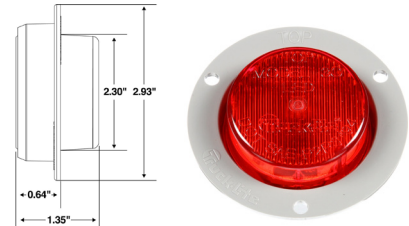

30[®] SERIES, FLANGE MOUNT, ABS LED, 2" ROUND



Part Number	Lens Color	Lamp Connector	Volts	Amps	Diodes	Lighting Codes
30271Y	Yellow	Fit 'N Forget M/C	12	0.05	2	ABS

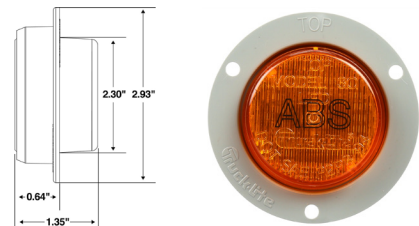

30[®] SERIES, FLANGE MOUNT, HIGH-PROFILE, LED, 2" ROUND



FEATURES

- SAE PC rated for combination clearance/ marker applications



Part Number	Lens Color	Lamp Connector	Plug Side 1	Plug Side 2	Volts	Amps	Diodes	Lighting Codes	Kit Includes
30379R	Red	Fit 'N Forget M/C	—	—	12	0.1	8	P2 P3 PC	—
30090R	Red	Fit 'N Forget M/C	Fit 'N Forget M/C	Female PL-10	12	0.1	8	P2 P3 PC	30379R light, 93745 plug
30379Y	Yellow	Fit 'N Forget M/C	—	—	12	0.1	8	P2 P3 PC	—
30090Y	Yellow	Fit 'N Forget M/C	Fit 'N Forget M/C	Female PL-10	12	0.1	8	P2 P3 PC	30379Y light, 93745 plug
30380R	Clear/Red	Fit 'N Forget M/C	—	—	12	0.1	8	P2 P3 PC	—
30380Y	Clear/Yellow	Fit 'N Forget M/C	—	—	12	0.1	8	P2 P3 PC	—

KIT

KIT



LED

30 SERIES

LED

30 SERIES

LED

30 SERIES

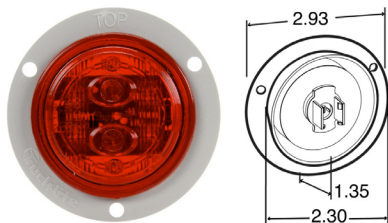

30[®] SERIES, FLANGE MOUNT, LOW-PROFILE, LED, 2" ROUND

FEATURES

- Long life fit and forget connection
- SAE PC rated for combination clearance/ marker applications



Part Number	Lens Color	Lamp Connector	Plug Side 1	Plug Side 2	Volts	Amps	Diodes	Lighting Codes	Kit Includes
30386R	Red	Fit 'N Forget M/C	—	—	12	0.12	6	P2 PC	—
30091R	Red	Fit 'N Forget M/C	Fit 'N Forget M/C	Female PL-10	12	0.12	6	P2 PC	30386R light, 93745 plug
30386Y	Yellow	Fit 'N Forget M/C	—	—	12	0.1	6	P2 PC	—
30091Y	Yellow	Fit 'N Forget M/C	Fit 'N Forget M/C	Female PL-10	12	0.12	6	P2 PC	30386Y light, 93745 plug

(KIT)

(KIT)

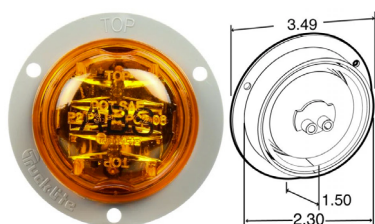

30[®] SERIES, FLANGE MOUNT, ABS HIGH-PROFILE, LED, 2" ROUND

FEATURES

- SAE PC rated for combination clearance/ marker applications



Part Number	Lens Color	Lamp Connector	Volts	Amps	Diodes	Lighting Codes
30269Y	Yellow	PL-10	12	0.1	8	ABS



30[®] SERIES, FLANGE MOUNT, HIGH-PROFILE, LED, 2" ROUND

FEATURES

- SAE PC rated for combination clearance/ marker applications



Part Number	Lens Color	Lamp Connector	Plug Side 1	Plug Side 2	Volts	Amps	Diodes	Lighting Codes	Kit Includes
30279R	Red	PL-10	—	—	12	0.1	8	P2 P3 PC	—
30080R	Red	PL-10	PL-10	.180 Bullet/ Ring Terminal	12	0.1	8	P2 P3 PC	30279R light, 94964 plug
30279Y	Yellow	PL-10	—	—	12	0.1	8	P2 P3 PC	—
30080Y	Yellow	PL-10	PL-10	.180 Bullet/ Ring Terminal	12	0.1	8	P2 P3 PC	30279Y light, 94964 plug



30[®] SERIES, FLANGE MOUNT, ABS LOW-PROFILE, LED, 2" ROUND

FEATURES

- SAE PC rated for combination clearance/ marker applications



Part Number	Lens Color	Lamp Connector	Mount Color	Volts	Amps	Diodes	Lighting Codes
30288R	Red	PL-10	Black	12	0.12	6	P2 PC
30288Y	Yellow	PL-10	Black	12	0.12	6	P2 PC
30289R	Red	PL-10	Grey	12	0.12	6	P2 PC
30289Y	Yellow	PL-10	Grey	12	0.12	6	P2 PC

LED

30 SERIES

LED

30 SERIES

LED

30 SERIES

LED

30 SERIES

LED

30 SERIES

30[®] SERIES, FLUSH MOUNT, 2" ROUND, LED



FEATURES

- Two diode, flange mount design
- Encapsulated electronics
- LEDs have no filament, therefore are not susceptible to shock and vibration
- Less current draw, resulting in increased battery and alternator life while allowing more power for other vehicle requirements
- Not suitable for PC requirements

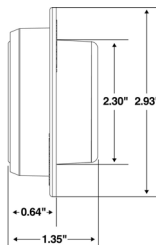

Part Number	Lens Color	Lamp Connector	Plug Side 1	Plug Side 2	Volts	Amps	Diodes	Lighting Codes	Kit Includes
30051R	Red	Fit 'N Forget M/C	Fit 'N Forget M/C	Female PL-10	12	0.05	2	P2 P3	30251R light, 93745 plug
30051Y	Yellow	Fit 'N Forget M/C	Fit 'N Forget M/C	Female PL-10	12	0.05	2	P2 P3	30251Y light, 93745 plug
30060R	Red	Fit 'N Forget M/C	Fit 'N Forget M/C	Stripped End	12 24	0.05	3	E1	30265R light, 94781 plug
30060Y	Yellow	Fit 'N Forget M/C	Fit 'N Forget M/C	Stripped End	12 24	0.05	3	E1	30265R light, 94781 plug
30065Y	Yellow	Fit 'N Forget M/C	Fit 'N Forget M/C	Blunt Cut	12 24	0.05	3	E1	30265Y light, 94609 plug

(KIT)

(KIT)

(KIT)

(KIT)

(KIT)

LED

30 SERIES

30[®] SERIES, FLUSH MOUNT, LOW-PROFILE, 2" ROUND, LED



FEATURES

- Two diode, flange mount design
- Encapsulated electronics
- LEDs have no filament, therefore are not susceptible to shock and vibration
- Less current draw, resulting in increased battery and alternator life while allowing more power for other vehicle requirements
- Not suitable for PC requirements
- Low Profile lamp design reduces damage risk from tree limbs and dock seals
- Polycarbonate lens

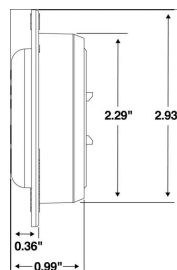

Part Number	Lens Color	Lamp Connector	Plug Side 1	Plug Side 2	Volts	Amps	Diodes	Lighting Codes	Kit Includes
30272R	Red	Fit 'N Forget M/C	—	—	12	0.05	2	P2 P3	—
30071R	Red	Fit 'N Forget M/C	Fit 'N Forget M/C	Female PL-10	12	0.05	2	P2 P3	30272R light, 93745 plug
30272Y	Yellow	Fit 'N Forget M/C	—	—	12	0.05	2	P2 P3	—
30071Y	Yellow	Fit 'N Forget M/C	Fit 'N Forget M/C	Female PL-10	12	0.05	2	P2 P3	30272Y light, 93745 plug

(KIT)

(KIT)

LED

30 SERIES

30[®] SERIES, SURFACE MOUNT, 2" ROUND, LED



FEATURES

- Direct pin-to-circuit board solders assure vibration-resistant contacts
- Electronics completely sealed in epoxy to resist corrosion and moisture
- Low current draw, leaving more power for other vehicle requirements
- Sonically sealed lens and housing
- OmniVolt universal lighting products address increasing vehicle power demands by operating equally in electrical systems that range from 10 to 30 volts

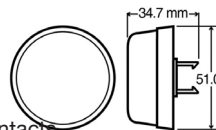

Part Number	Lens Color	Lamp Connector	Plug Side 1	Plug Side 2	Volts	Amps	Diodes	Lighting Codes	Kit Includes
30061R	Red	Fit 'N Forget M/C	Fit 'N Forget M/C	Stripped End	12 24	0.05	3	E Mark	30262R light, 94782 plug
30061Y	Yellow	Fit 'N Forget M/C	Fit 'N Forget M/C	Stripped End	12 24	0.05	3	E Mark	30262Y light, 94782 plug

(KIT)

(KIT)

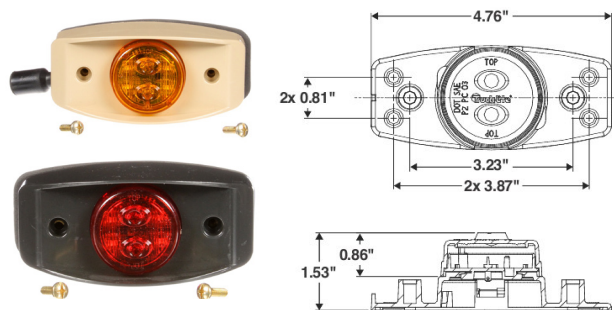

30[®] SERIES, BRACKET MOUNT, LED, KIT

FEATURES

- Complies with FMVSS 108 requirements
- Brackets utilize standard military color scheme
- Kits include a deflector mount with an inner bracket that allows cam-on of the lamp for quick installation
- Manufactured out of ABS material
- OmniVolt Technology (12 or 24 volt systems will run without adjustment)
- LED life surpasses the 2000 hours of incandescent bulbs by nearly 50x
- Lens and housing assemblies constructed of impact-resistant polycarbonate
- All electronics fully sealed in epoxy, making lamps less susceptible to shock and vibration
- Faster start-up times and low current draw



Part Number	Lens Color	Mount Color	Lamp Connector	Plug Side 1	Plug Side 2	Volts	Amps Major/Minor	Diodes	Lighting Codes
07394	Yellow	Tan	Fit 'N Forget M/C	Fit 'N Forget M/C	Female Military Boot/Ring Terminal	12 24	0.14/0.06	6	P2 PC
07395	Red	Black	Fit 'N Forget M/C	Fit 'N Forget M/C	Female Military Boot/Ring Terminal	12 24	0.14/0.06	6	P2 PC
07396	Yellow	Black	Fit 'N Forget M/C	Fit 'N Forget M/C	Female Military Boot/Ring Terminal	12 24	0.14/0.06	6	P2 PC
07393	Red	Tan	Fit 'N Forget M/C	Fit 'N Forget M/C	Female Military Boot/Ring Terminal	12 24	0.1	6	P2 PC



SIGNAL-STAT, GROMMET MOUNT, 2" ROUND, LED

FEATURES

- Unique combination of colored LEDs with clear lens draws attention to the lamp only when lit on 3051/3051A
- Standard connection
- Electronics completely sealed
- Not suitable for PC requirements



Part Number	Lens Color	Lamp Connector	Volts	Amps	Diodes	Lighting Codes
3050	Red	PL-10	12	0.05	6	P2
3050A	Yellow	PL-10	12	0.05	6	P2
3051	Clear/Red	PL-10	12	0.05	6	P2
3051A	Clear/Yellow	PL-10	12	0.05	6	P2



SIGNAL-STAT, GROMMET MOUNT, 2" ROUND, LED

FEATURES

- Standard connection
- Encapsulated electronics
- Not suitable for PC requirements



Part Number	Lens Color	Lamp Connector	Volts	Amps	Diodes	Lighting Codes
3058	Red	PL-10	12	0.05	1	P2
3058A	Yellow	PL-10	12	0.05	1	P2

LED

SIGNAL-STAT

SIGNAL-STAT, FLANGE MOUNT, 2" ROUND, LED



FEATURES

- Standard connection
- Unique 6 diode design
- Encapsulated electronics
- Not suitable for PC requirements



Part Number	Lens Color	Lamp Connector	Mount Color	Volts	Amps	Diodes	Lighting Codes
3053	Red	PL-10	Grey	12	0.05	6	P2
3053A	Yellow	PL-10	Grey	12	0.05	6	P2
3070	Red	PL-10	Grey	12	0.05	6	P2
3070A	Yellow	PL-10	Grey	12	0.05	6	P2

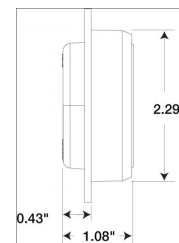

INCANDESCENT

30 SERIES

30[®] SERIES, GROMMET MOUNT, 2" ROUND, INCANDESCENT



FEATURES

- "ABS" version complies with FMVSS 108 requirement for ABS malfunction indicator lamp on trailer and ABS braking systems
- 12 volt, 15,000-hour-rated bulb life
- Lamp designed for PC requirements on a 45-degree angle in mounting devices #30720, #00801, #00803, #00804 or surface-mount flange

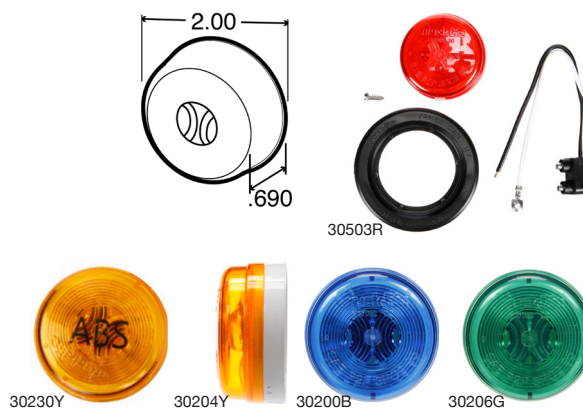
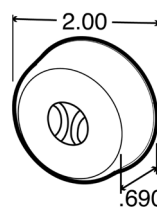

Part Number	Lens Color	Lamp Connector	Plug Side 1	Plug Side 2	Volts	Amps	Bulbs	Lighting Codes	Kit Includes
30200R	Red	PL-10	—	—	12	0.33	1	P2 P3 PC	—
30503R	Red	PL-10	PL-10	Ring Terminal/ Stripped End	12	0.33	1	P2 P3 PC	30200R light, 30700 grommet, 94902 plug
30200Y	Yellow	PL-10	—	—	12	0.33	1	P2 P3 PC	—
30503Y	Yellow	PL-10	PL-10	Ring Terminal/ Stripped End	12	0.33	1	P2 P3 PC	30200Y light, 30700 grommet, 94902 plug
30200B	Blue	PL-10	—	—	12	0.33	1	Auxiliary	—
30200G	Green	PL-10	—	—	12	0.33	1	Auxiliary	—
30204R	Red	PL-10	—	—	12	0.33	1	P2 PC	—
30204Y	Yellow	PL-10	—	—	12	0.33	1	P2 PC	—
30206G	Green	PL-10	—	—	24	0.17	1	Auxiliary	—
30206R	Red	PL-10	—	—	24	0.17	1	P2 P3 PC	—
30206Y	Yellow	PL-10	—	—	24	0.17	1	P2 P3 PC	—
30230Y	Yellow	PL-10	—	—	12	0.33	1	ABS	—
30257Y	Yellow	PL-10	—	—	12	0.33	1	ABS	—

Ⓚ

Ⓚ

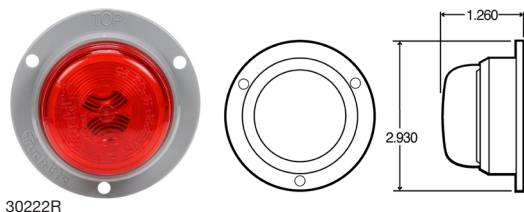

30222R

30[®] SERIES, FLANGE MOUNT, 2" ROUND, INCANDESCENT

FEATURES

- 12 volt, 15,000-hour-rated bulb



Part Number	Lens Color	Mount Color	Lamp Connector	Volts	Amps	Bulbs	Lighting Codes
30222R	Red	Gray	PL-10	12	0.33	1	P2 PC
30222Y	Yellow	Gray	PL-10	12	0.33	1	P2 PC

INCANDESCENT

30 SERIES

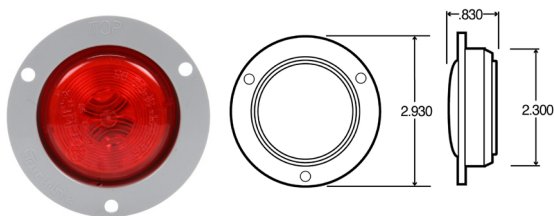

30[®] SERIES, FLUSH MOUNT, 2" ROUND, INCANDESCENT

- Flanges are permanently affixed to lamp
- 12 volt, 15,000-hour-rated bulb
- Flush mount is not suitable for PC requirements



Part Number	Lens Color	Mount Color	Lamp Connector	Volts	Amps	Bulbs	Lighting Codes
30221R	Red	Gray	PL-10	12	0.33	1	P2
30221Y	Yellow	Gray	PL-10	12	0.33	1	P2

INCANDESCENT

30 SERIES



30[®] SERIES, BRACKET MOUNT, 2" ROUND, INCANDESCENT, KIT

FEATURES

- High-impact plastic deflector mount
- Allows quick and easy surface mounting of 2" diameter lamps
- Meets PC requirements on a 45-degree angle using standard combination lamps
- Not recommended for LED applications|Replaces Signal-Stat 9388



Part Number	Lens Color	Mount Color	Lamp Connector	Plug Side 2	Volts	Amps	Bulbs	Lighting Codes	Kit Includes
30504R	Red	Gray	PL-10	Ring Terminal/ Stripped End	12	0.33	1	P2 P3 PC	30200R light, 30701 grommet, 30722 bracket, 94902 plug
30504Y	Yellow	Gray	PL-10	Ring Terminal/ Stripped End	12	0.33	1	P2 P3 PC	30200Y light, 30701 grommet, 30722 bracket, 94902 plug

INCANDESCENT

30 SERIES

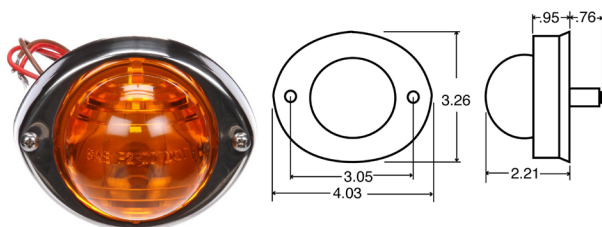

26 SERIES, 2 SCREW, BRACKET MOUNT 2" ROUND, INCANDESCENT

FEATURES

- Popular in bus applications
- Provide marker and auxiliary side-turn indicator functions
- Features stainless steel and two holes for #10 screws on 1.625" centers
- Clearance hole of .812 diameter required



Part Number	Lens Color	Mount Color	Lamp Connector	Plug Side 1	Plug Side 2	Volts	Amps	Bulbs	Lighting Codes
26390Y	Yellow	Silver	Hardwired	Hardwired	Stripped End	12	0.27	1	P2

INCANDESCENT

26 SERIES

LED

10 SERIES

10[®] SERIES, GROMMET MOUNT, 2.5" ROUND, LED



FEATURES

- Most commonly used 2 1/2" round clearance light, with weather tight connection
- Waterproof completely sealed electronics
- Single and bulk packs available
- American made and designed
- Grommet design for easy installation

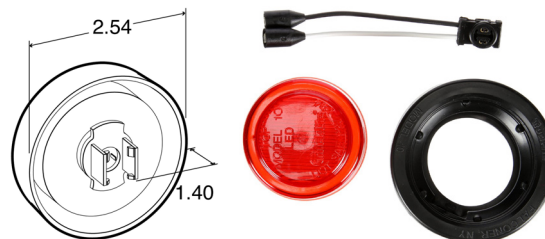

Part Number	Lens Color	Lamp Connector	Plug Side 1	Plug Side 2	Volts	Amps	Diodes	Lighting Codes	Kit Includes
10250R	Red	Fit 'N Forget M/C	—	—	12	0.03	2	P2	—
10050R	Red	Fit 'N Forget M/C	Fit 'N Forget M/C	Female PL-10	12	0.03	2	P2	10250R lamp, 10700 grommet, 93745 plug (KIT)
10250Y	Yellow	Fit 'N Forget M/C	—	—	12	0.08	2	P2	—
10050Y	Yellow	Fit 'N Forget M/C	Fit 'N Forget M/C	Female PL-10	12	0.08	2	P2	10250Y lamp, 10700 grommet, 93745 plug (KIT)
10256R	Red	Fit 'N Forget M/C	—	—	12 24	0.05	3	P2	—
10256Y	Yellow	Fit 'N Forget M/C	—	—	12 24	0.05	3	P2	—

LED

10 SERIES

10[®] SERIES, GROMMET MOUNT, HIGH-PROFILE, LED, 2.5" ROUND



FEATURES

- Dome design allows for SAE PC rated combination clearance/marker applications
- Comes in both weather tight and standard connections

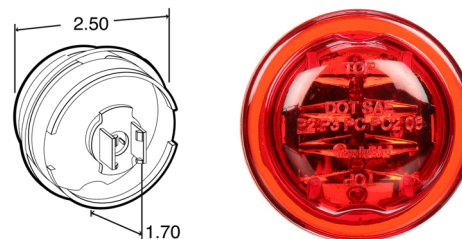

Part Number	Lens Color	Lamp Connector	Plug Side 1	Plug Side 2	Volts	Amps	Diodes	Lighting Codes	Kit Includes
10375R	Red	Fit 'N Forget M/C	—	—	12	0.1	8	P2, P3, PC	—
10085R	Red	Fit 'N Forget M/C	Fit 'N Forget M/C	Female PL-10	12	0.1	8	P2, P3, PC	10375R lamp, 10700 grommet, 93745 plug (KIT)
10375Y	Yellow	Fit 'N Forget M/C	—	—	12	0.1	8	P2, P3, PC	—
10085Y	Yellow	Fit 'N Forget M/C	Fit 'N Forget M/C	Female PL-10	12	0.1	8	P2, P3, PC	10375Y lamp, 10700 grommet, 93745 plug (KIT)

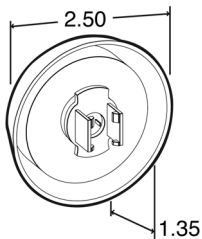

10[®] SERIES, GROMMET MOUNT, LOW-PROFILE, LED, 2.5" ROUND

FEATURES

- 2-1/2" clearance and marker lamp
- Grommet design for easy installation
- American made and designed
- Polycarbonate lens



Part Number	Lens Color	Lamp Connector	Plug Side 1	Plug Side 2	Volts	Amps	Diodes	Lighting Codes	Kit Includes
10385R	Red	Fit 'N Forget M/C	—	—	12	0.1	8	P2, P3, PC	—
10076R	Red	Fit 'N Forget M/C	Fit 'N Forget M/C	Female PL-10	12	0.1	8	P2, P3, PC	10385R lamp, 10700 grommet, 93745 plug (KIT)
10385Y	Yellow	Fit 'N Forget M/C	—	—	12	0.1	8	P2, P3, PC	—
10076Y	Yellow	Fit 'N Forget M/C	Fit 'N Forget M/C	Female PL-10	12	0.1	8	P2, P3, PC	10385Y lamp, 10700 grommet, 93745 plug (KIT)

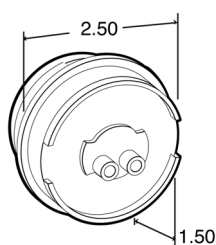

10[®] SERIES, GROMMET MOUNT, HIGH-PROFILE, LED, 2.5" ROUND

FEATURES

- 2-1/2" clearance and marker lamp
- Grommet design for easy installation
- American made and designed
- Polycarbonate lens



Part Number	Lens Color	Lamp Connector	Plug Side 1	Plug Side 2	Volts	Amps	Diodes	Lighting Codes	Kit Includes
10275R	Red	PL-10	—	—	12	0.1	8	P2, P3, PC	—
10075R	Red	PL-10	PL-10	.180 Bullet/Ring Terminal	12	0.1	8	P2, P3, PC	10275R lamp, 10700 grommet, 93745 plug (KIT)
10275Y	Yellow	PL-10	—	—	12	0.1	8	P2, P3, PC	—
10075Y	Yellow	PL-10	PL-10	.180 Bullet/Ring Terminal	12	0.1	8	P2, P3, PC	10275Y lamp, 10700 grommet, 93745 plug (KIT)

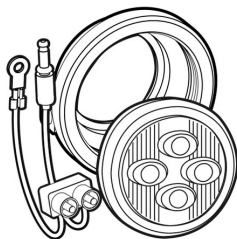

10[®] SERIES, GROMMET MOUNT, LOW-PROFILE, LED, 2.5" ROUND

FEATURES

- Unique lens optics allows for SAE PC rated combination clearance/marker applications.
- Has standard PL-10 connection



Part Number	Lens Color	Lamp Connector	Plug Side 1	Plug Side 2	Volts	Amps	Diodes	Lighting Codes	Kit Includes
10286R	Red	PL-10	—	—	12	0.1	8	P2, PC	—
10086R	Red	PL-10	PL-10	.180 Bullet/Ring Terminal	12	0.1	8	P2, PC	10286R lamp, 10700 grommet, 94964 plug (KIT)
10286Y	Yellow	PL-10	—	—	12	0.1	8	P2, PC	—
10086Y	Yellow	PL-10	PL-10	.180 Bullet/Ring Terminal	12	0.1	8	P2, PC	10286Y lamp, 10700 grommet, 94964 plug (KIT)

10[®] SERIES, FLANGE MOUNT, 2.5" ROUND, LED



FEATURES

- Most advanced and cost-effective 2-1/2" clearance and marker lamp
- Completely sealed electronics resist corrosion and moisture
- Less current draw, resulting in increased battery and alternator life while allowing more power for other vehicle requirements
- Polycarbonate lens

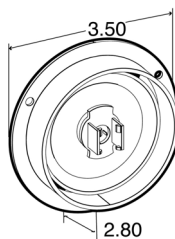

Part Number	Lens Color	Lamp Connector	Plug Side 1	Plug Side 2	Volts	Amps	Diodes	Lighting Codes	Kit Includes
10251R	Red	Fit 'N Forget M/C	—	—	12	0.03	2	P2	—
10051R	Red	Fit 'N Forget M/C	Fit 'N Forget M/C	Female PL-10	12	0.03	2	P2	10251R light, 93745 plug (KIT)
10251Y	Yellow	Fit 'N Forget M/C	—	—	12	0.08	2	P2	—
10051Y	Yellow	Fit 'N Forget M/C	Fit 'N Forget M/C	Female PL-10	12	0.08	2	P2	10251Y light, 93745 plug (KIT)
10271Y	Yellow	Fit 'N Forget M/C	—	—	12	0.08	2	ABS	—

10[®] SERIES, FLANGE MOUNT, HIGH-PROFILE, 2.5" ROUND, LED



FEATURES

- Most advanced and cost-effective 2-1/2" clearance and marker lamp
- Completely sealed electronics resist corrosion and moisture
- Less current draw
- Polycarbonate lens

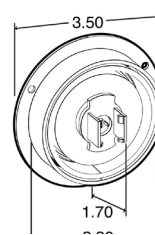

Part Number	Lens Color	Lamp Connector	Plug Side 1	Plug Side 2	Volts	Amps	Diodes	Lighting Codes	Kit Includes
10379R	Red	Fit 'N Forget M/C	—	—	12	0.1	8	P2, P3, PC	—
10090R	Red	Fit 'N Forget M/C	Fit 'N Forget M/C	Female PL-10	12	0.1	8	P2, P3, PC	10379R light, 93745 plug (KIT)
10379Y	Yellow	Fit 'N Forget M/C	—	—	12	0.1	8	P2, P3, PC	—
10090Y	Yellow	Fit 'N Forget M/C	Fit 'N Forget M/C	Female PL-10	12	0.1	8	P2, P3, PC	10379Y light, 93745 plug (KIT)

10[®] SERIES, FLANGE MOUNT, HIGH-PROFILE, 2.5" ROUND, LED



FEATURES

- Most advanced and cost-effective 2-1/2" clearance and marker lamp
- Completely sealed electronics resist corrosion and moisture
- Less current draw
- Polycarbonate lens



Part Number	Lens Color	Lamp Connector	Plug Side 1	Plug Side 2	Volts	Amps	Diodes	Lighting Codes	Kit Includes
10279R	Red	PL-10	—	—	12	0.1	8	P2, P3, PC	—
10079R	Red	PL-10	PL-10	.180 Bullet/Ring Terminal	12	0.1	8	P2, P3, PC	10279R light, 94964 plug (KIT)
10279Y	Yellow	PL-10	—	—	12	0.1	8	P2, P3, PC	—
10079Y	Yellow	PL-10	PL-10	.180 Bullet/Ring Terminal	12	0.1	8	P2, P3, PC	10279Y light, 94964 plug (KIT)

LED

10 SERIES

LED

10 SERIES

LED

10 SERIES

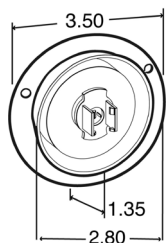

10[®] SERIES, FLUSH MOUNT, 2.5" ROUND, LED

FEATURES

- Unique lens optics allows for SAE PC rated combination clearance/marker applications.
- Fit and forget plug for weather tight connection



Part Number	Lens Color	Mount Color	Lamp Connector	Plug Side 1	Plug Side 2	Volts	Amps	Diodes	Lighting Codes	Kit Includes
10092R	Red	Black	Fit 'N Forget M/C	Fit 'N Forget M/C	Female PL-10	12	0.1	8	P2, PC	10391R light, 93745 plug
10092Y	Yellow	Black	Fit 'N Forget M/C	Fit 'N Forget M/C	Female PL-10	12	0.1	8	P2, PC	10391Y light, 93745 plug



10091R-kit

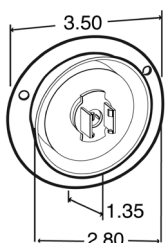

10[®] SERIES, FLUSH MOUNT, LOW-PROFILE, 2.5" ROUND, LED

FEATURES

- Most advanced and cost-effective 2-1/2" clearance and marker lamp
- Completely sealed electronics resist corrosion and moisture
- Less current draw
- SAE PC rate for combination marker and clearance lamps
- Low profile reducing of physical damage
- Polycarbonate lens



Part Number	Lens Color	Mount Color	Lamp Connector	Plug Side 1	Plug Side 2	Volts	Amps	Diodes	Lighting Codes	Kit Includes
10389R	Red	Gray	Fit 'N Forget M/C	—	—	12	0.1	8	P2, PC	—
10091R	Red	Gray	Fit 'N Forget M/C	Fit 'N Forget M/C	Female PL-10	12	0.1	8	P2, PC	10389R light, 93745 plug
10389Y	Yellow	Gray	Fit 'N Forget M/C	—	—	12	0.1	8	P2, PC	—
10091Y	Yellow	Gray	Fit 'N Forget M/C	Fit 'N Forget M/C	Female PL-10	12	0.1	8	P2, PC	10389Y light, 93745 plug



10089Y-kit



10288R-kit

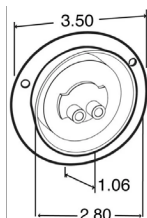

10[®] SERIES, FLUSH MOUNT, LOW-PROFILE, 2.5" ROUND, LED

FEATURES

- Unique lens optics allows for SAE PC rated combination clearance/marker applications
- Has standard PL-10 connection



Part Number	Lens Color	Mount Color	Lamp Connector	Plug Side 1	Plug Side 2	Volts	Amps	Diodes	Lighting Codes	Kit Includes
10289R	Red	Gray	PL-10	—	—	12	0.1	8	P2, PC	—
10089R	Red	Gray	PL-10	PL-10	.180 Bullet/Ring Terminal	12	0.1	8	P2, PC	10289R light, 94964 plug
10289Y	Yellow	Gray	PL-10	—	—	12	0.1	8	P2, PC	—
10089Y	Yellow	Gray	PL-10	PL-10	.180 Bullet/Ring Terminal	12	0.1	8	P2, PC	10289Y light, 94964 plug
10288R	Red	Black	PL-10	—	—	12	0.1	8	P2, PC	—
10288Y	Yellow	Black	PL-10	—	—	12	0.1	8	P2, PC	—

LED

SIGNAL-STAT

MODEL 10, GROMMET MOUNT, 2.5" ROUND, LED



FEATURES

- Standard connection. Unique 6 diode light output
- Economy versions feature one diode design.
- Unique combination of colored LEDs with clear lens draws attention to the lamp only when lit on 1051 and 1051A
- Electronics completely sealed
- Not suitable for PC requirements

Part Number	Lens Color	Lamp Connector	Volts	Amps	Diodes	Lighting Codes
1050	Red	PL-10	12	0.05	6	P2
1050A	Yellow	PL-10	12	0.05	6	P2
1051	Clear/Red	PL-10	12	0.05	6	P2
1051A	Clear/Yellow	PL-10	12	0.05	6	P2
1058	Red	PL-10	12	0.05	1	P2
1058A	Yellow	PL-10	12	0.05	1	P2

LED

SIGNAL-STAT

MODEL 10, REFLECTORIZED, GROMMET MOUNT, 2.5" ROUND, LED



FEATURES

- Reflex lens, grommet mount.
- Standard connection. Unique four diode design.
- Electronics completely sealed
- Not suitable for PC requirements

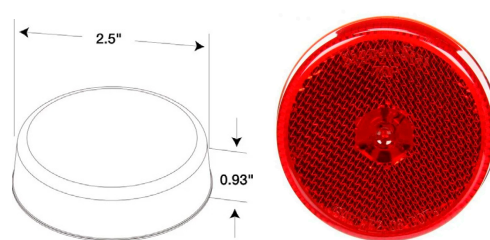

Part Number	Lens Color	Lamp Connector	Volts	Amps	Diodes	Lighting Codes
1052	Red	PL-10	12	0.01	4	A P2
1052A	Yellow	PL-10	12	0.01	4	A P2

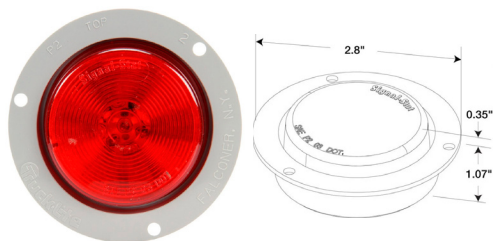

MODEL 10, FLUSH FLANGE MOUNT, 2.5" ROUND, LED

FEATURES

- Flange mounted
- Standard connection. Unique 6 diode light output
- Electronics completely sealed
- Not suitable for PC requirements



Part Number	Lens Color	Mount Color	Lamp Connector	Volts	Amps	Diodes	Lighting Codes
1053	Red	Grey	PL-10	12	0.05	6	P2
1053A	Yellow	Grey	PL-10	12	0.05	6	P2
1070	Red	Grey	PL-10	12	0.05	6	P2
1070A	Yellow	Grey	PL-10	12	0.05	6	P2

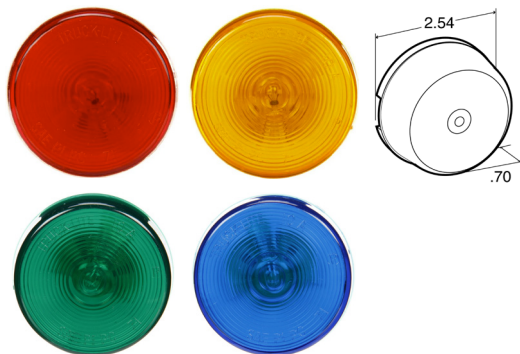

10[®] SERIES, NON-REFLECTORIZED, GROMMET MOUNT, 2.5" ROUND, INCANDESCENT

FEATURES

- Lens and housing are sonically sealed
- High-impact polycarbonate construction
- 15,000-hour-rated bulb life
- Available in either 12 volt or 24 volt
- Meets PC requirement on a 45-degree angle in mounting devices #10708, #10720, #00803 or #00804



Part Number	Lens Color	Lamp Connector	Plug Side 1	Plug Side 2	Volts	Amps	Bulbs	Lighting Codes	Kit Includes
10202R	Red	PL-10	—	—	12	0.33	1	P2 PC	—
10519R	Red	PL-10	PL-10	Ring Terminal/ Stripped End	12	0.33	1	P2 PC	10202R light, 10700 grommet, 94902 plug
10202Y	Yellow	PL-10	—	—	12	0.33	1	P2 PC	—
10519Y	Yellow	PL-10	PL-10	Ring Terminal/ Stripped End	12	0.33	1	P2 PC	10202Y light, 10700 grommet, 94902 plug
10202B	Blue	PL-10	—	—	12	0.33	1	Auxillary	—
10202G	Green	PL-10	—	—	12	0.33	1	Auxillary	—
10204R	Red	PL-10	—	—	24	0.17	1	P2 PC	—
10204Y	Yellow	PL-10	—	—	24	0.17	1	P2 PC	—

LED

SIGNAL-STAT

INCANDESCENT

10 SERIES

(KIT)

(KIT)

10[®] SERIES, REFLECTORIZED, GROMMET MOUNT, 2.5" ROUND, INCANDESCENT



FEATURES

- Lens and housing are sonically sealed
- High-impact polycarbonate construction
- 15,000-hour-rated bulb life
- Meets PC requirement on a 45-degree angle in mounting devices #10708, #10720, #00803 or #00804



Part Number	Lens Color	Lamp Connector	Plug Side 1	Plug Side 2	Volts	Amps	Bulbs	Lighting Codes	Kit Includes
10205R	Red	PL-10	—	—	12	0.33	1	A P2 PC	—
10525R	Red	PL-10	PL-10	Ring Terminal/ Stripped End	12	0.33	1	A P2 PC	10205R light, 10700 grommet, 94902 plug KIT
10205Y	Yellow	PL-10	—	—	12	0.33	1	A P2 PC	—
10525Y	Yellow	PL-10	PL-10	Ring Terminal/ Stripped End	12	0.33	1	A P2 PC	10205Y light, 10700 grommet, 94902 plug KIT

SUPER 10[®] SERIES, ABS, GROMMET MOUNT, 2.5" ROUND, INCANDESCENT



FEATURES

- Unique shock-mount extends bulb life
- 15,000-hour-rated bulb life
- Sealed polycarbonate lens and housing
- Meets PC requirements on a 45-degree angle using all mounting devices

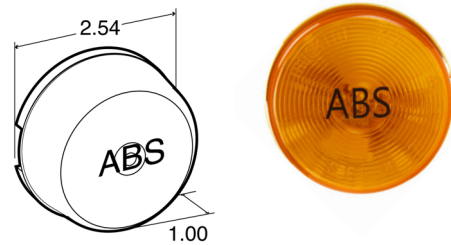

Part Number	Lens Color	Lamp Connector	Plug Side 1	Plug Side 2	Volts	Amps	Bulbs	Lighting Codes	Kit Includes
10212Y	Yellow	PL-10	—	—	12	0.33	1	ABS	—
10213Y	Yellow	PL-10	—	—	12	0.33	1	ABS	—

SUPER 10[®] SERIES, REFLECTORIZED, GROMMET MOUNT, 2.5" ROUND, INCANDESCENT



FEATURES

- Unique shock-mount extends bulb life
- 15,000-hour-rated bulb life
- Sealed polycarbonate lens and housing
- Meets PC requirements on a 45-degree angle using all mounting devices

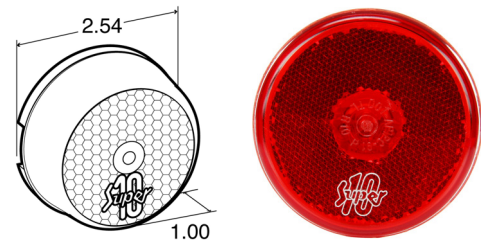

Part Number	Lens Color	Lamp Connector	Plug Side 1	Plug Side 2	Volts	Amps	Bulbs	Lighting Codes	Kit Includes
10208R	Red	PL-10	—	—	12	0.33	1	P2 PC A	—
10028R	Red	PL-10	PL-10	Ring Terminal/ Stripped End	12	0.33	1	P2 PC A	10208R light, 10700 grommet, 94902 plug KIT
10208Y	Yellow	PL-10	—	—	12	0.33	1	P2 PC A	—
10028Y	Yellow	PL-10	PL-10	Ring Terminal/ Stripped End	12	0.33	1	P2 PC A	10208Y light, 10700 grommet, 94902 plug KIT

INCANDESCENT

10 SERIES

INCANDESCENT

SUPER 10 SERIES

INCANDESCENT

SUPER 10 SERIES

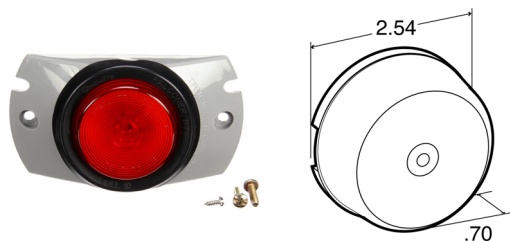

**10[®] SERIES, BRACKET MOUNT
2.5" ROUND, INCANDESCENT**

FEATURES

- Rust-resistant stainless steel mount
- Quick cam-on, cam-off lamp installation
- Suitable for PC requirements on a 45-degree angle using all 2-1/2" diameter lamps
- Mounts with screws to surface
- Model 10 kits available
- Replaces Signal-Stat 9394



Part Number	Lens Color	Mount Color	Lamp Connector	Plug Side 1	Plug Side 2	Volts	Amps	Bulbs	Lighting Codes	Kit Includes
10520R	Red	Gray	PL-10	PL-10	Ring Terminal Stripped End	12	0.33	1	P2 PC	10202R light, 10700 grommet, 10725 bracket, 94902 plug
10520Y	Yellow	Gray	PL-10	PL-10	Ring Terminal Stripped End	12	0.33	1	P2 PC	10202Y light, 10700 grommet, 10725 bracket, 94902 plug
10004R	Red	Silver	PL-10	PL-10	Ring Terminal Stripped End	12	0.33	1	A P2 PC	10202R light, 10720 bracket, 94902 plug
10004Y	Yellow	Silver	PL-10	PL-10	Ring Terminal Stripped End	12	0.33	1	A P2 PC	10202R light, 10720 bracket, 94902 plug

KIT

KIT

KIT

KIT

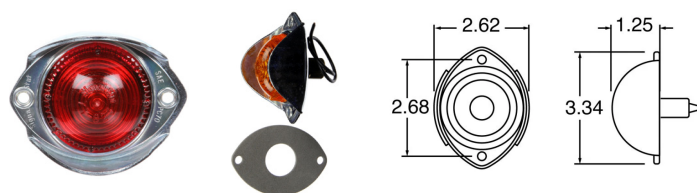

**SIGNAL-STAT, 1 BULB,
STEEL FLANGE MOUNT, 2.5" ROUND,**

FEATURES

- Armored styling helps prevent damage to bulb and lens
- Twist-off lens
- Uses #67 bulb
- Specially treated gasket seals out dirt and moisture
- Reinforced mounting holes provide maximum strength



Part Number	Lens Color	Mount Color	Lamp Connector	Plug Side 1	Plug Side 2	Volts	Amps	Bulbs	Lighting Codes
1116	Red	Silver	Socket Assembly	Socket Assembly	Stripped End	12	0.59	1	P2 PC
1116A	Yellow	Silver	Socket Assembly	Socket Assembly	Stripped End	12	0.59	1	P2 PC

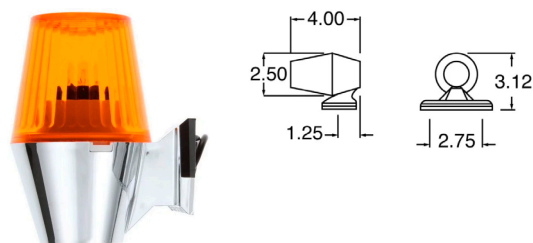

**SIGNAL-STAT, HARDWIRED,
2 SCREW, 2.5" ROUND, INCANDESCENT,
BULB REPLACEABLE**

FEATURES

- High-impact polycarbonate, chrome finish housing
- Triple-plated chrome finish housing will not rust or corrode
- Snap-on lens permits easy bulb and lens replacement
- Versatile installation-mounts on any flat or contoured surface without disassembly
- Neoprene mounting pad seals out dirt and moisture
- Uses #168 Bulb



Part Number	Lens Color	Mount Color	Lamp Connector	Plug Side 1	Plug Side 2	Volts	Amps	Bulbs	Lighting Codes
1319	Red	Chrome	Socket Assembly	Socket Assembly	Stripped End	12	0.33	1	P2 PC
1319A	Yellow	Chrome	Socket Assembly	Socket Assembly	Stripped End	12	0.33	1	P2 PC

INCANDESCENT

10 SERIES

INCANDESCENT

SIGNAL-STAT

INCANDESCENT

SIGNAL-STAT

INCANDESCENT

MACK, REFLECTORIZED
2 SCREW, 2.5" ROUND,



FEATURES

- Mack #38MO343RP3
- Mack replacement marker lamp with reflector meets legal requirements for reflector when mounted between 15 to 60 inches from ground level
- 93" wiring harness for use on fiberglass fenders
- Cadmium plated steel housing

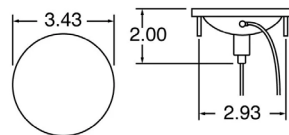

Part Number	Lens Color	Lamp Connector	Plug Side 1	Plug Side 2	Volts	Amps	Bulbs	Lighting Codes
1590A	Yellow	Hardwired	Hardwired	Ring Terminal	12	0.33	1	A P2

SIGNAL-STAT

LED

33[®] SERIES, SINGLE FUNCTION,
GROMMET MOUNT, LED, 0.75" ROUND



33256Y



33050R

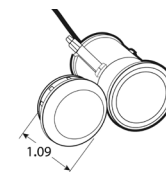

FEATURES

- World smallest LED marker lamp for the transportation industry
- Marker function exceeds P2 legal requirements
- PC rated lamps marked PC on lens
- Requires a 0.75 mounting hole
- Hardwired lamp with .180 male bullet design can be easily retrofitted
- Engineered to withstand the toughest working environments
- Electronics sealed in epoxy to resist corrosion and moisture
- Complies with FMVSS-108 marker/clearance requirements

Part Number	Lens Color	Lamp Connector	Plug Side 1	Plug Side 2	Volts	Amps Major/Minor	Lighting Codes	Kit Includes
33250R	Red	Hardwired	Hardwired	.180 Bullet	12	0.05	P2	—
33050R	Red	Hardwired	Hardwired	.180 Bullet	12	0.05	P2	33250R light, 33700 grommet
33250Y	Yellow	Hardwired	Hardwired	.180 Bullet	12	0.05	P2	—
33050Y	Yellow	Hardwired	Hardwired	.180 Bullet	12	0.05	P2	33250Y light, 33700 grommet
33275R	Red	Hardwired	Hardwired	.180 Bullet	12	0.14	P2 PC	—
33075R	Red	Hardwired	Hardwired	.180 Bullet	12	0.14	P2 PC	33275R light, 33700 grommet
33275Y	Yellow	Hardwired	Hardwired	.180 Bullet	12	0.14	P2 PC	—
33075Y	Yellow	Hardwired	Hardwired	.180 Bullet	12	0.14	P2 PC	33275Y light, 33700 grommet
33256Y	Yellow	Hardwired	Hardwired	Ring Terminal	12	0.03	P2	—
33285Y	Clear/ Yellow	Hardwired	Hardwired	.180 Bullet	12	0.14	P2 PC	—
33285R	Clear/ Red	Hardwired	Hardwired	.180 Bullet	12	0.14	P2 PC	—

(KIT)

(KIT)

(KIT)

(KIT)

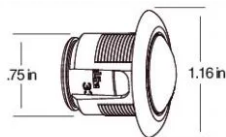

Flange Mount

• Flange material thickness .040" - .250"

33[®] SERIES, SINGLE FUNCTION, FLANGE MOUNT, LED, 0.75" ROUND

FEATURES

- World's smallest LED marker lamp for the transportation industry
- PC rated lamp, marked PC on the lens
- Hardwired lamp design is easily retrofitted
- Offers trailer engineers and manufacturers new trailer and rear door structure design flexibility
- Requires 3/4" mounting hole
- Reduces lighting costs due to physical damage and heat entrapment
- Material thickness for flange is 040" - 250"



Part Number	Lens Color	Mount Color	Lamp Connector	Plug Side 1	Plug Side 2	Volts	Amps Major/Minor	Lighting Codes	Kit Includes
33051R	Red	Black	Hardwired	Hardwired	.180 Bullet	12	0.05	P2	33250R light, 33800 flange
33051Y	Yellow	Black	Hardwired	Hardwired	.180 Bullet	12	0.05	P2	33250Y light, 33800 flange
33080R	Red	Black	Hardwired	Hardwired	.180 Bullet	12	0.14	P2 PC	33275R light, 33800 flange
33080Y	Yellow	Black	Hardwired	Hardwired	.180 Bullet	12	0.14	P2 PC	33275Y light, 33800 flange

KIT
KIT
KIT
KIT

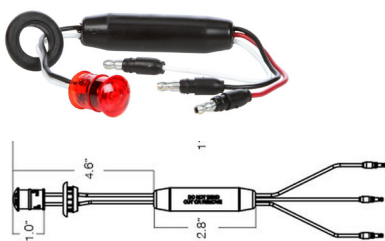

33[®] SERIES, DUAL FUNCTION, GROMMET MOUNT, LED, 0.75" ROUND, KIT

FEATURES

- World's smallest LED marker lamp for the transportation industry
- PC rated lamp, marked PC on the lens
- Hardwired lamp design is easily retrofitted
- Offers trailer engineers and manufacturers new trailer and rear door structure design flexibility
- Requires 3/4" mounting hole
- Reduces lighting costs due to physical damage and heat entrapment
- Material thickness for grommet is 125" - 250"
- 33209Y has 4" more of lead between lamp and mold



Part Number	Lens Color	Lamp Connector	Plug Side 1	Plug Side 2	Volts	Amps Major/Minor	Diodes	Lighting Codes	Kit Includes
33203R	Red	Hardwired	Hardwired	.180 Bullet	12	0.17/0.02	1	P2	33700 grommet
33203Y	Yellow	Hardwired	Hardwired	.180 Bullet	12	0.12/0.02	1	P2	33700 grommet
33204R	Red	Hardwired	Hardwired	.180 Bullet	12	0.17/0.02	1	P2	33275 grommet
33204Y	Yellow	Hardwired	Hardwired	.180 Bullet	12	0.12/0.03	1	P2	33275 grommet; sealing grommet for .125 - .250 plate thickness
33205R	Red	Hardwired	Hardwired	.180 Bullet	12	0.17/0.02	1	P2	33720 grommet; sealing grommet for 0.07"-0.125" plate thickness
33205Y	Yellow	Hardwired	Hardwired	.180 Bullet	12	0.12/0.03	1	P2	33720 grommet
33206R	Red	Hardwired	Hardwired	.180 Bullet	12	0.17/0.02	1	P2	33702 grommet; closed back grommet
33206Y	Yellow	Hardwired	Hardwired	.180 Bullet	12	0.12/0.03	1	P2	33702 grommet
33209Y	Yellow	Hardwired	Hardwired	.180 Bullet	12	0.12/0.03	1	P2	33700 grommet

KIT
KIT
KIT
KIT
KIT
KIT
KIT
KIT
KIT

LED

33 SERIES

33[®] SERIES, DUAL FUNCTION, FLANGE MOUNT, LED, 0.75" ROUND



FEATURES

- World's smallest LED marker lamp for the transportation industry
- Provides increased visibility when braking or turning
- Functions as a marker, auxiliary turn and auxiliary stop when properly installed
- Best-in-class auxiliary brake function is seven times brighter than marker function
- Marker function exceeds P2 legal requirements
- Requires a 0.75" mounting hole
- Hardwired lamp with .180 male bullet design can be easily retrofitted
- Engineered to withstand the toughest working environments
- Electronics sealed in epoxy to resist corrosion and moisture
- Complies with FMVSS-108 marker/clearance requirements

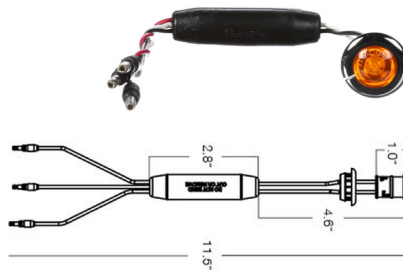

Part Number	Lens Color	Mount Color	Lamp Connector	Plug Side 1	Plug Side 2	Volts	Amps Major/Minor	Lighting Codes	Kit Includes
33207R	Red	Black	Hardwired	Hardwired	.180 Bullet	12	0.17/0.02	P2	33800 flange
33207Y	Yellow	Black	Hardwired	Hardwired	.180 Bullet	12	0.12/0.03	P2	33800 flange (KIT)
33208R	Red	Chrome	Hardwired	Hardwired	.180 Bullet	12	0.17/0.02	P2	33810 flange
33208Y	Yellow	Chrome	Hardwired	Hardwired	.180 Bullet	12	0.12/0.03	P2	33810 flange (KIT)

LED

15 SERIES

15[®] SERIES, BRACKET MOUNT LED, 1" X 2" RECTANGULAR



FEATURES

- Designed to fit applications requiring minimal space
- Less susceptible to shock and vibration
- Uses standard mounting holes and accessories
- Not suitable for PC applications
- Direct pin-to-circuit board solders assure vibration resistant contacts

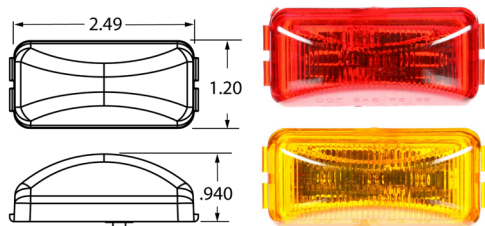

Part Number	Lens Color	Lamp Connector	Volts	Amps	Diodes	Lighting Codes
15250R	Red	PL-10	12	0.05	1	P2, P3
15250Y	Yellow	PL-10	12	0.05	3	P2, P3

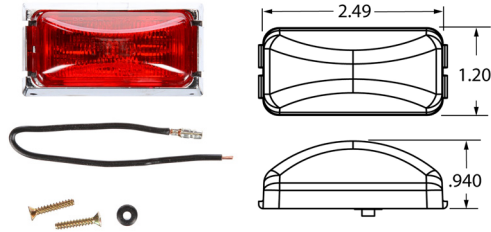

15[®] SERIES, BRACKET MOUNT, LED, 1" X 2", RECTANGULAR, KIT

FEATURES

- Sure contact, self-grounding feature
- Submersible for marine use
- Polycarbonate lens



Part Number	Lens Color	Mount Color	Lamp Connector	Plug Side 1	Plug Side 2	Volts	Amps	Diodes	Lighting Codes	Kit Includes
15033R	Red	Chrome	.156 Bullet Hot Wire	.156 Bullet Hot Wire	Stripped End	12	0.05	1	P2	15250R light, 00793 bracket, 96904 wire
15033Y	Yellow	Chrome	.156 Bullet Hot Wire	.156 Bullet Hot Wire	Stripped End	12	0.05	3	P2	15250Y light, 00793 bracket, 96904 wire

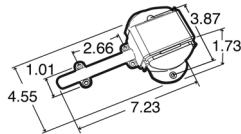

15[®] SERIES, DUAL FACE, BRACKET MOUNT, LED, 1" X 2" RECTANGULAR, KIT

FEATURES

- Designed for use on most utility trailer fenders
- Wire cover is marked in 1/2" increments for easy length modifications
- Polycarbonate lens
- Includes wire harness



Part Number	Position	Lens Color	Mount Color	Lamp Connector	Plug Side 1	Plug Side 2	Volts	Amps	Diodes	Lighting Codes	Kit Includes
15417	LH	Red Yellow	Black	PL-10	PL-10	Blunt Cut	12	0.05	4	P2	15250R & 15250Y light, 15731 bracket mount
15418	RH	Red Yellow	Black	PL-10	PL-10	Blunt Cut	12	0.05	4	P2	15250R & 15250Y light, 15731 bracket mount

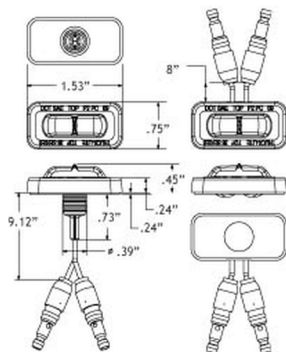

36 SERIES, FLEX-LITE, ADHESIVE MOUNT, LED, 1" X 2" RECTANGULAR

FEATURES

- Lamps adhere directly to application surface through the use of heavy-duty adhesive backing
- Hardwired lamp design is easily retrofit able
- Rear exit wire version requires a 3/8 mounting hole, and self-seals hole upon installation
- Side mount options can be mounted without any mounting holes
- LEDs draw much less current, allowing more power for other vehicle requirements
- Electronics are completely sealed in epoxy to resist damage caused by moisture and corrosion
- Reduces lighting costs caused by physical damage and heat entrapment



Part Number	Lens Color	Exit Wire	Lamp Connector	Plug Side 1	Plug Side 2	Volts	Amps Major/Minor	Diodes	Lighting Codes
36105R	Red	Side	Hardwired	Hardwired	.180 Bullet	12	0.03	3	P2 PC
36105Y	Yellow	Side	Hardwired	Hardwired	.180 Bullet	12	0.05	3	P2 PC
36115R	Red	Rear	Hardwired	Hardwired	.180 Bullet	12	0.03	3	P2 PC
36115Y	Yellow	Rear	Hardwired	Hardwired	.180 Bullet	12	0.05	3	P2 PC

36 SERIES, DUAL FUNCTION, ADHESIVE MOUNT, LED, 1" X 2" RECTANGULAR



FEATURES

- Lamps operate in minor and major output levels; major function activated by the brake function or turn signal
- Yellow Major function is 3 times brighter than minor function
- Red Major function is 7 times brighter than minor function
- Lamps adhere directly to application surface through use of heavy-duty adhesive backing
- Electronics are completely sealed in epoxy to resist damage caused by moisture and corrosion
- Easy-to-install peel-off liner
- Care should be taken for proper installation

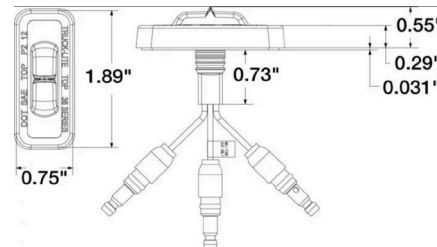

Part Number	Lens Color	Mount Color	Lamp Connector	Plug Side 1	Plug Side 2	Volts	Amps Major/Minor	Diodes	Lighting Codes
36203R	Red	Black	Hardwired	Hardwired	.180 Bullet	12	0.06/0.01	3	P2
36203Y	Yellow	Black	Hardwired	Hardwired	.180 Bullet	12	0.06/0.02	3	P2

36 SERIES, ADHESIVE MOUNT/2 SCREW, WINGED, LED, 1" X 2" RECTANGULAR



FEATURES

- Winged housing provides option for mounting around corners on a radius
- Provides a clearance/marker solution that requires no mounting brackets or installation screws
- Lamps adhere directly to application surface through the use of heavy-duty adhesive backing
- Easy-to-install, peel-off liner
- Hardwired lamp design is easily retrofitted
- Rear exit wire version requires a 3/8" mounting hole, and self-seals hole upon installation
- Side mount options can be mounted without any mounting holes
- Reduces lighting costs caused by physical damage and heat entrapment



Part Number	Lens Color	Wire Exit	Lamp Connector	Plug Side 1	Plug Side 2	Volts	Amps Major/Minor	Diodes	Lighting Codes
36100R	Red	Side	Hardwired	Hardwired	.180 Bullet	12	0.03	3	P2 PC
36100Y	Yellow	Side	Hardwired	Hardwired	.180 Bullet	12	0.05	3	P2 PC
36110R	Red	Rear	Hardwired	Hardwired	.180 Bullet	12	0.03	3	P2 PC
36110Y	Yellow	Rear	Hardwired	Hardwired	.180 Bullet	12	0.05	3	P2 PC
36130R	Red	Rear	Hardwired	Hardwired	.180 Bullet/ .180 Bullet Recepticle	12 24	0.05	3	P2 PC
36130Y	Yellow	Rear	Hardwired	Hardwired	.180 Bullet/ .180 Bullet Recepticle	12 24	0.05	3	P2 PC



three wire, dual function

Part Number	Lens Color	Wire Exit	Lamp Connector	Plug Side 1	Plug Side 2	Volts	Amps Major/Minor	Diodes	Lighting Codes
36213R	Red	Rear	Hardwired	Hardwired	.180 Bullet	12	0.06/0.01	3	P2 PC

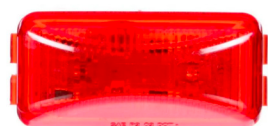

1560



1561A

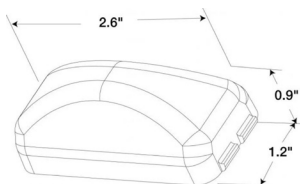

SIGNAL-STAT, GROMMET MOUNT, LED, 1" X 2" RECTANGULAR

FEATURES

- Standard connection
- 2 Diode (red), 3 diode (yellow) LED pattern
- Encapsulated electronics prevent damage from moisture and corrosion
- Unique combination of colored LEDs with clear lens draws attention to the lamp only when lit on 1561 and 1561A



Part Number	Lens Color	Lamp Connector	Plug Side 1	Plug Side 2	Volts	Amps Major/Minor	Diodes	Lighting Codes
1560	Red	PL-10	No Plug	No Plug	12	0.03	2	P2
1560A	Yellow	PL-10	No Plug	No Plug	12	0.05	3	P2
1561	Clear/Red	PL-10	No Plug	No Plug	12	0.03	2	P2
1561A	Clear/Yellow	PL-10	No Plug	No Plug	12	0.05	3	P2

LED
36 SERIES



15006R



15006Y

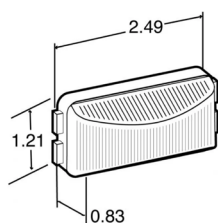

15[®] SERIES, BRACKET MOUNT, RECTANGULAR 1" X 2", INCANDESCENT, KIT

FEATURES

- Extra-strength plastic construction
- Features top cut-out area on mount #15727 for narrow rail design
- Easy snap-in lamp installation
- Suitable for PC requirements with incandescent lamps



Part Number	Lens Color	Mount	Lamp Connector	Plug Side 1	Plug Side 2	Volts	Amps	Bulb	Lighting Codes	Kit Includes
15006R	Red	White Rail Mount	PL-10	PL-10	Ring Terminal/Stripped End	12	0.33	1	P2 PC	15200R light, 15727 bracket, 94924 plug (KIT)
15006Y	Yellow	White Rail Mount	PL-10	PL-10	Ring Terminal/Stripped End	12	0.33	1	P2 PC	15200Y light, 15727 bracket, 94924 plug (KIT)
15008R	Red	White Rail Mount	PL-10	PL-10	Ring Terminal/Stripped End	12	0.33	1	P2 PC	15200R light, 15728 bracket, 94924 plug (KIT)
15008Y	Yellow	White Rail Mount	PL-10	PL-10	Ring Terminal/Stripped End	12	0.33	1	P2 PC	15200Y light, 15728 bracket, 94924 plug (KIT)
15506R	Red	Chrome Adapter Mount	.156 Bullet Hot Wire	.156 Bullet Hot Wire	Stripped End	12	0.33	1	P2 PC	15200R light, 00793 bracket, 96904 plug (KIT)
15506Y	Yellow	Chrome Adapter Mount	.156 Bullet Hot Wire	.156 Bullet Hot Wire	Stripped End	12	0.33	1	P2 PC	15200Y light, 00793 bracket, 96904 plug (KIT)
15507R	Red	Black Adapter Mount	.156 Bullet Hot Wire	.156 Bullet Hot Wire	Stripped End	12	0.33	1	P2 PC	15200R light, 00809 bracket, 96913 hot wire (KIT)
15507Y	Yellow	Black Adapter Mount	.156 Bullet Hot Wire	.156 Bullet Hot Wire	Stripped End	12	0.33	1	P2 PC	15200Y light, 00809 bracket, 96913 hot wire (KIT)

INCANDESCENT

15 SERIES

15[®] SERIES, BRACKET MOUNT
1" X 2", INCANDESCENT, REC.



FEATURES

- Fits in most narrow header rails
- Mounts vertically or horizontally
- Long-life, 15,000-hour bulb
- Snap-lock tabs allow quick and easy installation
- Suitable for PC requirements on a 45-degree angle

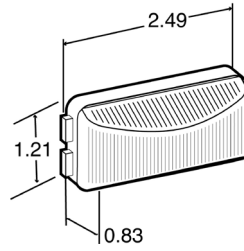

Part Number	Lens Color	Lamp Connector	Volts	Amps	Bulbs	Lighting Codes
15200R	Red	PL-10	12	0.33	1	P2 PC
15200Y	Yellow	PL-10	12	0.33	1	P2 PC
15201R	Red	PL-10	24	0.17	1	P2 PC
15201Y	Yellow	PL-10	24	0.17	1	P2 PC

15[®] SERIES, BRACKET MOUNT, ABS
1" X 2", INCANDESCENT REC.



FEATURES

- Fits in most narrow header rails
- Mounts vertically or horizontally
- Long-life, 15,000-hour bulb
- Snap-lock tabs allow quick and easy installation
- Suitable for PC requirements on a 45-degree angle

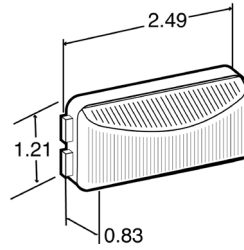

Part Number	Lens Color	Lamp Connector	Volts	Amps	Bulbs	Lighting Codes
15203Y	Yellow	PL-10	12	0.33	1	ABS

15[®] SERIES, DUAL FACE, BRACKET MOUNT, 1" X 2", INCANDESCENT REC., KIT



FEATURES

- Designed for use on most utility trailer fenders
- Wire cover is marked in 1/2" increments for easy length modifications
- Includes wire harness

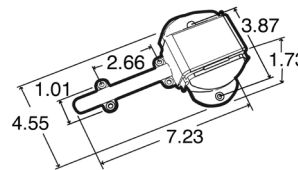

Part Number	Lens Color	Mount Color	Lamp Connector	Plug Side 1	Plug Side 2	Volts	Amps	Bulb	Lighting Codes	Kit Includes
15415	Red Yellow	Black	Fit 'N Forget M/C	Fit 'N Forget M/C	Blunt Cut	12	0.33	1	P2	15200R/Y lights, 15731 bracket (KIT)
15416	Red Yellow	Black	Fit 'N Forget M/C	Fit 'N Forget M/C	Blunt Cut	12	0.33	1	P2	15200R/Y lights, 15731 bracket (KIT)

INCANDESCENT

15 SERIES

INCANDESCENT

15 SERIES

INCANDESCENT

15 SERIES

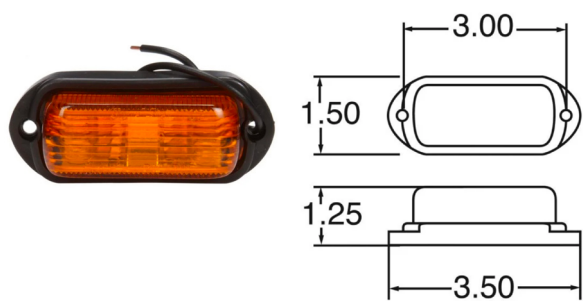

SIGNAL-STAT, 2 SCREW, LED, 1" X 2" RECTANGULAR

FEATURES

- Compact styling is ideal for narrow body channel mounting
- External mounting holes allow mounting without disassembly
- Black rubber housing
- Snap-in lens permits easy bulb and lens replacement|Aluminum base provides mounting strength and durability
- Two stainless steel ground straps ensure electrical connection
- Two bulb design available (1506 model) - if one burns out, the other remains lighted
- Uses #1895 bulb



Part Number	Lens Color	Lamp Connector	Plug Side 1	Plug Side 2	Volts	Amps Major/Minor	Material	Diodes	Lighting Codes
1506	Red	Hardwired	Hardwired	Stripped End	12	0.03	AC	2	P2 PC
1506A	Yellow	Hardwired	Hardwired	Stripped End	12	0.05	AC	2	P2 PC

LED
SIGNAL-STAT

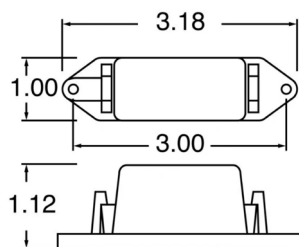

SIGNAL-STAT, 2 SCREW, BULB REPLACEABLE, 1" X 2" REC.

FEATURES

- High-impact polycarbonate construction
- Mini lamp features external mounting holes
- Lens snaps and locks into base
- Mounts without disassembly
- Replaces Truck-Lite 26306
- Uses #1895 bulb



Part Number	Lens Color	Lamp Connector	Plug Side 1	Plug Side 2	Volts	Amps	Material	Bulb	Lighting Codes
1507	Clear/Red	Hardwired	Hardwired	Stripped End	12	0.27	PC	2	P2
1507A	Clear/Yellow	Hardwired	Hardwired	Stripped End	12	0.27	PC	2	P2

LED
SIGNAL-STAT

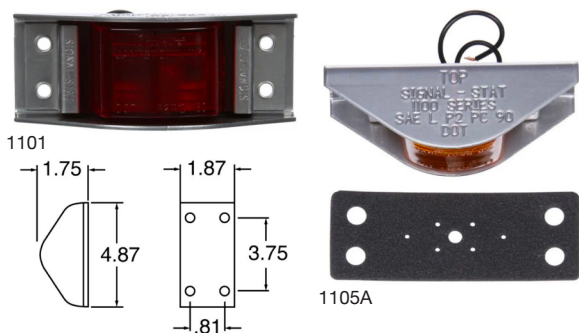

SIGNAL-STAT, 4 SCREW, LED, 1" X 2" REC.

FEATURES

- Aluminum or gray painted steel housing
- Fully protected lens with high guard
- Pressure pad tightly seals lens
- Quick-click lens removal
- Uses #168 bulb



Part Number	Lens Color	Lamp Connector	Plug Side 1	Plug Side 2	Volts	Amps	Material	Bulbs	Lighting Codes
1101	Red	Hardwired	Hardwired	Stripped End	12	0.03	Grey Steel	1	P2 PC
1101A	Yellow	Hardwired	Hardwired	Stripped End	12	0.03	Grey Steel	1	P2 PC
1102	Red	Hardwired	Hardwired	Stripped End	12	0.03	Silver Aluminum	1	P2 PC
1102A	Yellow	Hardwired	Hardwired	Stripped End	12	0.03	Silver Aluminum	1	P2 PC
1105	Red	Hardwired	Hardwired	Stripped End	12	0.03	Silver Steel	1	P2 PC
1105A	Yellow	Hardwired	Hardwired	Stripped End	12	0.03	Silver Steel	1	P2 PC

LED
SIGNAL-STAT

19[®] SERIES, BASE MOUNT, LED, 1" X 4" RECTANGULAR, P2



FEATURES

- Innovative optic design allows combination lamp to function as two
- Draws less current, allowing more power for other vehicle requirements
- Designed to fit applications requiring minimal space
- Must be mounted horizontally

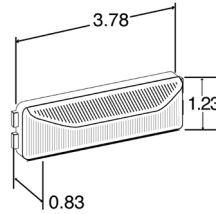

19350R



19032R - kit

Part Number	Lens Color	Mount Color	Lamp Connector	Plug Side 1	Plug Side 2	Volts	Amps	Diodes	Lighting Codes	Kit Includes
19350Y	Yellow	-	Fit 'N Forget M/C	-	-	12	0.05	6	P2	-
19350R	Red	-	Fit 'N Forget M/C	-	-	12	0.05	2	P2	-
19031R	Red	Chrome	Fit 'N Forget M/C	Fit 'N Forget M/C	.180 Bullet/Ring Terminal	12	0.05	2	P2	19350R light, 19748 bracket, 94718 plug (KIT)
19032R	Red	Black/PC	Fit 'N Forget M/C	Fit 'N Forget M/C	.180 Bullet/Ring Terminal	12	0.05	2	P2	19350R light, 19728 bracket, 94718 plug (KIT)

19[®] SERIES, BASE MOUNT, LED, 1" X 4" RECTANGULAR, P2



FEATURES

- Innovative optic design allows combination lamp to function as two
- Draws less current, allowing more power for other vehicle requirements
- Designed to fit applications requiring minimal space
- Must be mounted horizontally

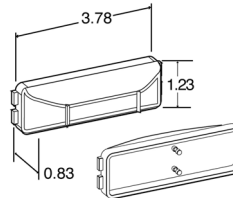

19006Y



19251Y

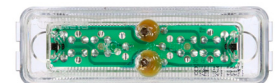

Part Number	Lens Color	Mount Color	Lamp Connector	Plug Side 1	Plug Side 2	Volts	Amps	Diodes	Lighting Codes	Kit Includes
19250R	Red	-	19 Series Male Pin	-	-	12	0.05	2	P2	-
19006R	Red	Gray	19 Series Male Pin	19 Series Male Pin	Stripped End	12	0.05	2	P2	19250R light, 19721 bracket (KIT)
19250Y	Yellow	-	19 Series Male Pin	-	-	12	0.05	4	P2	-
19006Y	Yellow	Gray	19 Series Male Pin	19 Series Male Pin	Stripped End	12	0.05	4	P2	19250Y light, 19721 bracket (KIT)
19251R	Clear Red	-	19 Series Male Pin	-	-	12	0.05	2	P2	-
19251Y	Clear Yellow	-	19 Series Male Pin	-	-	12	0.05	6	P2	-

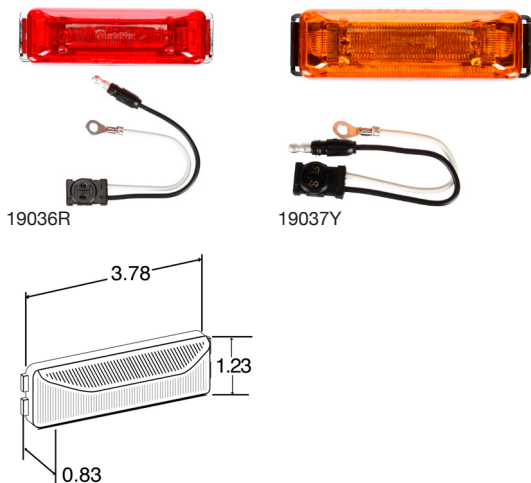

19[®] SERIES, BASE MOUNT, LED, 1" X 4" RECTANGULAR, P2|PC

FEATURES

- Innovative optic design allows combination lamp to function as two
- Designed to fit applications requiring minimal space
- Unique plug-in design for ease of installation|Must be mounted horizontally
- Low-profile, extra-strength basePC-rated lamps meets requirements when mounted on a 45 degree angle
- PC-rated red lamps and standard yellow lamps have 4-diode pattern
- PC-rated yellow lamps have 6-diode pattern



Part Number	Lens Color	Mount Color	Lamp Connector	Plug Side 1	Plug Side 2	Volts	Amps	Diodes	Lighting Codes	Kit Includes
19375R	Red	-	Fit 'N Forget M/C	-	-	12	0.05	4	P2 PC	-
19036R	Red	Chrome	Fit 'N Forget M/C	Fit 'N Forget M/C	.180 Bullet/Ring Terminal	12	0.05	4	P2 PC	19375R light, 19748 bracket, 94718 plug (KIT)
19037R	Red	Black/ABS	Fit 'N Forget M/C	Fit 'N Forget M/C	.180 Bullet/Ring Terminal	12	0.05	4	P2 PC	19375R light, 19728 bracket, 94718 plug (KIT)
19375Y	Yellow	-	Fit 'N Forget M/C	-	-	12	0.12	6	P2 PC	-
19036Y	Yellow	Chrome	Fit 'N Forget M/C	Fit 'N Forget M/C	.180 Bullet/Ring Terminal	12	0.09	6	P2 PC	19375Y light, 19748 bracket, 94718 plug (KIT)
19037Y	Yellow	Black/ABS	Fit 'N Forget M/C	Fit 'N Forget M/C	.180 Bullet/Ring Terminal	12	0.09	6	P2 PC	19375Y light, 19728 bracket, 94718 plug (KIT)

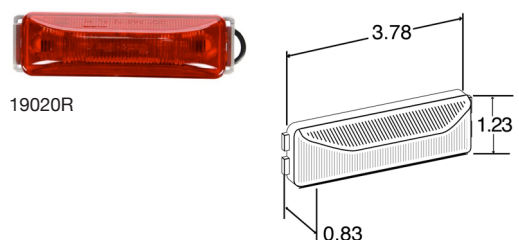

19[®] SERIES, BASE MOUNT, LED, 1" X 4" RECTANGULAR, P2|PC

FEATURES

- Innovative optic design allows combination lamp to function as two
- Designed to fit applications requiring minimal space
- Must be mounted horizontally
- PC-rated lamps meets requirements when mounted on a 45 degree angle
- PC-rated red lamps and standard yellow lamps have 4-diode pattern
- PC-rated yellow lamps have 6-diode pattern



Part Number	Lens Color	Mount Color	Lamp Connector	Plug Side 1	Plug Side 2	Volts	Amps	Diodes	Lighting Codes	Kit Includes
19275R	Red	-	19 Series Male Pin	-	-	12	0.05	4	P2 PC	-
19020R	Red	Grey	19 Series Male Pin	19 Series Male Pin	Stripped End	12	0.05	4	P2 PC	19275R light, 19721 bracket (KIT)
19275Y	Yellow	-	19 Series Male Pin	-	-	12	0.12	6	P2 PC	-
19020Y	Yellow	Grey	19 Series Male Pin	19 Series Male Pin	Stripped End	12	0.05	6	P2 PC	19275Y light, 19721 bracket (KIT)

35[®] SERIES, 2 SCREW
LED, 1" X 4" RECTANGULAR, P2



FEATURES

- Slim 3/4" wide design makes lamp perfect solution for narrow rail designs
- Must be mounted horizontally
- Optional gasket to improve seal between lamp and body
- Unique combination of colored LEDs with clear lens draws attention to the lamp only when lit on 35201R and 35201Y
- Not suitable for PC requirements

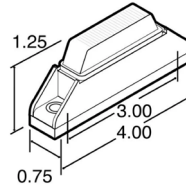

35201R



35001Y - kit



35880Y

Part Number	Lens Color	Lamp Connector	Plug Side 1	Plug Side 2	Volts	Amps	Diodes	Diamond Shell	Lighting Codes	Kit Includes
35201R	Clear Red	Fit 'N Forget M/C	—	—	12	0.05	2	No	P2	—
35201Y	Clear Yellow	Fit 'N Forget M/C	—	—	12	0.05	2	No	P2	—
35200R	Red	Fit 'N Forget M/C	—	—	12	0.05	1	No	P2	—
35001R	Red	Fit 'N Forget M/C	Fit 'N Forget M/C	.180 Bullet/Ring Terminal	12	0.05	1	No	P2	35200R light, 94862 plug (KIT)
35200Y	Yellow	Fit 'N Forget M/C	—	—	12	0.05	2	No	P2	—
35001Y	Yellow	Fit 'N Forget M/C	Fit 'N Forget M/C	.180 Bullet/Ring Terminal	12	0.05	2	No	P2	35200Y light, 94862 plug (KIT)
35880R	Red	Fit 'N Forget M/C	—	—	12	0.05	1	Yes	P2	—
35080R	Red	Fit 'N Forget M/C	Fit 'N Forget M/C	.180 Bullet/Ring Terminal	12	0.05	1	Yes	P2	35880R light, 94862 plug (KIT)
35880Y	Yellow	Fit 'N Forget M/C	—	—	12	0.05	1	Yes	P2	—
35080Y	Yellow	Fit 'N Forget M/C	Fit 'N Forget M/C	.180 Bullet/Ring Terminal	12	0.05	2	Yes	P2	35880Y light, 94862 plug (KIT)

35[®] SERIES, 2 SCREW
LED, 1" X 4" RECTANGULAR, P2|PC



FEATURES

- Slim 3/4" wide design makes lamp perfect solution for narrow rail designs
- Must be mounted horizontally
- Optional gasket to improve seal between lamp and body
- Optional gasket: 97035 sealing gasket

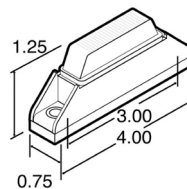

35001Y - kit

Part Number	Lens Color	Lamp Connector	Plug Side 1	Plug Side 2	Volts	Amps	Diodes	Diamond Shell	Lighting Codes	Kit Includes
35375R	Red	Fit 'N Forget M/C	—	—	12	0.12	7	No	P2 PC	—
35075R	Red	Fit 'N Forget M/C	Fit 'N Forget M/C	.180 Bullet/Ring Terminal	12	0.12	5	No	P2 PC	35375R light, 94862 plug (KIT)
35375Y	Yellow	Fit 'N Forget M/C	—	—	12	0.12	7	No	P2 PC	—
35075Y	Yellow	Fit 'N Forget M/C	Fit 'N Forget M/C	.180 Bullet/Ring Terminal	12	0.12	5	No	P2 PC	35375Y light, 94862 plug (KIT)



35890R



35004Y - kit

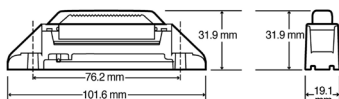

FEATURES

- Complies with SAE J592 and J594 when mounted horizontally
- Complies with SAE J592 when mounted horizontally between 0 degrees to 34 degrees rollback
- OmniVolt Technology (12 or 24V systems will run without adjustment)
- Form/Fit/Function replacements for current product
- LED life surpasses the 2k hours of incandescent bulbs by nearly 50x
- Lens and housing assemblies constructed of impact-resistant polycarbonate
- All electronics fully sealed in epoxy, making lamps less susceptible to shock and vibration
- Faster start-up times and low current draw



Part Number	Lens Color	Lamp Connector	Plug Side 1	Plug Side 2	Volts	Amps	Diodes	Lighting Codes	Kit Includes
35890R	Red	Fit 'N Forget M/C	—	—	12 24	0.05	2	P2 P3	—
35004R	Red	Fit 'N Forget M/C	Fit 'N Forget M/C	.180 Bullet/Ring Terminal	12 24	0.05	2	P2 P3	35890R light, 94862 KIT
35890Y	Yellow	Fit 'N Forget M/C	—	—	12 24	0.05	2	P2 P3	—
35004Y	Yellow	Fit 'N Forget M/C	Fit 'N Forget M/C	.180 Bullet/Ring Terminal	12 24	0.05	2	P2 P3	35890Y light, 94862 KIT



35007Y- kit



35207Y

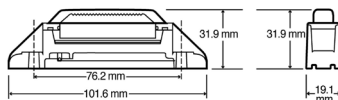

FEATURES

- Approved to comply with ECE regulations for side marker function
- Surface mounts horizontally with two screws on 76mm centers or with optional armored bracket
- Direct pin-to-circuit board solders assure vibration-resistant contacts
- Optional heavy-duty foam rubber gasket (97035) fully fills lamp recess for an improved watertight seal
- Narrow design allows mounting in limited space



Part Number	Lens Color	Lamp Connector	Plug Side 1	Plug Side 2	Volts	Amps	Diodes	Lighting Codes	Kit Includes
35207Y	Yellow	Fit 'N Forget M/C	—	—	12	0.08	7	E1	—
35007Y	Yellow	Fit 'N Forget M/C	Fit 'N Forget M/C	.180 Bullet/Ring Terminal	12	0.08	7	E1	35207Y light, 94862 plug KIT
35209Y	Yellow	Fit 'N Forget M/C	—	—	24	0.04	7	E1	—
35009Y	Yellow	Fit 'N Forget M/C	Fit 'N Forget M/C	.180 Bullet/Ring Terminal	24	0.04	7	E1	35209Y light, 94862 plug KIT

LED

SIGNAL-STAT

SIGNAL-STAT, 2 SCREW LED, 1" X 4" RECTANGULAR



FEATURES

- Full pattern light output
- Popular on show truck and owner-operator applications
- Hardwired design eliminates pin corrosion
- Not suitable for PC applications

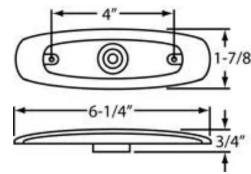

Part Number	Lens Color	Reflex Lens	Lamp Connector	Plug Side 1	Plug Side 2	Volts	Amps	Diodes	Material	Lighting Codes
2672A	Yellow	Yes	Hardwired	Hardwired	Ring Terminal Stripped End	12 24	0.05	12	AC	P2
2673	Red	No	Hardwired	Hardwired	Ring Terminal Stripped End	12 24	0.05	12	AC	P2
2673A	Yellow	No	Hardwired	Hardwired	Ring Terminal Stripped End	12 24	0.05	12	AC	P2

LED

SIGNAL-STAT

SIGNAL-STAT, 2 SCREW LED, 1" X 4" RECTANGULAR



FEATURES

- Full pattern light output
- Popular on show truck and owner-operator applications
- Hardwired design eliminates pin corrosion
- Not suitable for PC applications

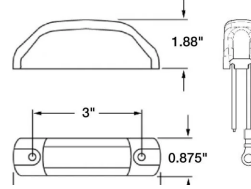

Part Number	Lens Color	Lamp Connector	Plug Side 1	Plug Side 2	Volts	Amps	Diodes	Material	Lighting Codes
3550	Red	Hardwired	Hardwired	Ring Terminal Stripped End	12	0.05	1	PC	P2
3550A	Yellow	Hardwired	Hardwired	Ring Terminal Stripped End	12	0.05	1	PC	P2

LED

SIGNAL-STAT

SIGNAL-STAT, BRACKET MOUNT, LED, 1" X 4" RECTANGULAR



FEATURES

- Standard connection
- 4 diode LED pattern
- Encapsulated electronics
- Unique combination of colored LEDs with clear lens draws attention to the lamp only when lit on 1961 and 1961A

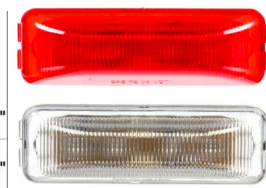
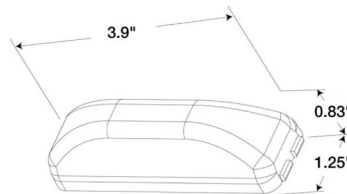

Part Number	Lens Color	Lamp Connector	Volts	Amps	Diodes	Lighting Codes
1960	Red	19 Series Male Pin	12	0.05	4	P2
1960A	Yellow	19 Series Male Pin	12	0.05	4	P2
1961	Clear Red	19 Series Male Pin	12	0.05	4	P2
1961A	Clear Yellow	19 Series Male Pin	12	0.05	4	P2

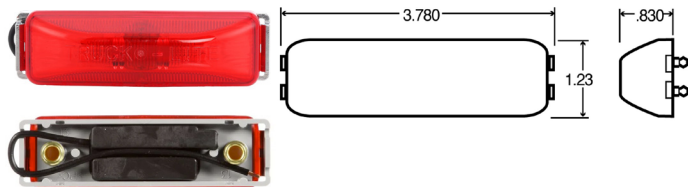

19[®] SERIES, BASE MOUNT INCANDESCENT, 1" X 4" REC. KIT

FEATURES

- Features unique plug-in design for ease of installation
- Low profile extra-strength base
- Suitable for pc requirements on a 45-degree angle



Part Number	Lens Color	Mount Color	Lamp Connector	Plug Side 1	Plug Side 2	Volts	Amps	Bulbs	Lighting Codes	Kit Includes
19002R	Red	Gray	19 Series Male Pin	19 Series Male Pin	Stripped End	12	0.33	2	P2 PC	19200R light, 19721 bracket
19002Y	Yellow	Gray	19 Series Male Pin	19 Series Male Pin	Stripped End	12	0.33	2	P2 PC	19200R light, 19721 bracket
19009R	Red	Chrome	19 Series Male Pin	19 Series Male Pin	Stripped End	12	0.33	2	P2 PC	19200R light, 19739 bracket
19009Y	Yellow	Chrome	19 Series Male Pin	19 Series Male Pin	Stripped End	12	0.33	2	P2 PC	19200Y light, 19739 bracket
19016R	Red	Black	19 Series Male Pin	-	-	12	0.33	2	P2 PC	19200R light, 19728 bracket
19016Y	Yellow	Black	19 Series Male Pin	-	-	12	0.33	2	P2 PC	19200Y light, 19728 bracket

INCANDESCENT

19 SERIES

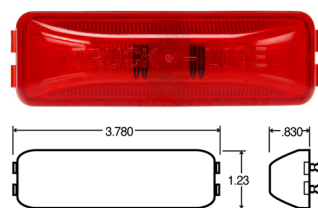

19[®] SERIES, MARKER/CLEARANCE INCANDESCENT, 1" X 4" REC.

FEATURES

- Designed to fit in limited mounting areas
- Fits in most narrow header rails
- Can be mounted vertically or horizontally
- Snap-lock tabs allow quick and easy installation



Part Number	Lens Color	Lamp Connector	Volts	Amps	Bulbs	Lighting Codes
19200R	Red	19 Series Male Pin	12	0.33	2	P2 P3 PC
19200Y	Yellow	19 Series Male Pin	12	0.33	2	P2 P3 PC

INCANDESCENT

19 SERIES

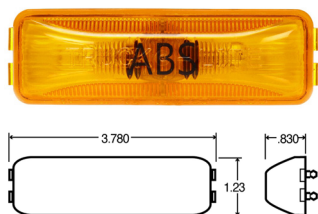

19[®] SERIES, BRACKET MOUNT, ABS INCANDESCENT, 1" X 4" REC. KIT

FEATURES

- Snap-lock tabs allow quick and easy installation



Part Number	Lens Color	Lamp Connector	Volts	Amps	Bulbs	Lighting Codes
19205Y	Yellow	19 Series Male Pin	12	0.33	2	ABS

INCANDESCENT

19 SERIES

12[®] SERIES, GROMMET MOUNT, LED, 2" X 3" RECTANGULAR

LED

12 SERIES



FEATURES

- SAE PC-rated for combination clearance/marker applications
- Snap-in lamp makes installation fast and easy
- Lamp gasket #97921 required for proper lamp and bracket fit
- Polycarbonate lens

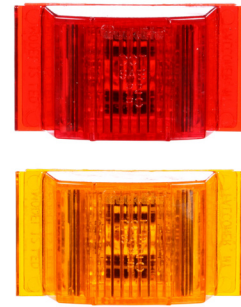
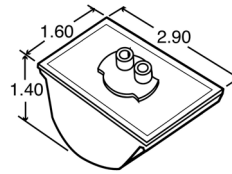

Part Number	Lens Color	Lamp Connector	Volts	Amps	Diodes	Lighting Codes
12275R	Red	PL-10	12	0.12	6	P2, PC
12275Y	Yellow	PL-10	12	0.12	6	P2, PC

SIGNAL-STAT, 2 SCREW, LED, 2" X 3" RECTANGULAR

LED

SIGNAL-STAT



FEATURES

- Features 2 super LEDs for a full pattern
- Chrome plated ABS plastic bezel
- Surface mount
- Mounting gasket included to protect seal against body
- Unique LED array displays full pattern output
- LEDs have no filament, therefore are extremely resistant to shock and vibration
- Epoxy-encapsulated electronics protect the lamp from damage caused by chemicals and moisture

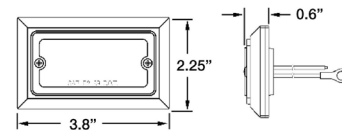

Part Number	Lens Color	Lamp Connector	Plug Side 1	Plug Side 2	Volts	Amps	Diodes	Material	Lighting Codes
2675	Red	Hardwired	Hardwired	Ring Terminal/ Stripped End	12	0.05	2	AC	P2
2675A	Yellow	Hardwired	Hardwired	Ring Terminal/ Stripped End	12	0.05	2	AC	P2

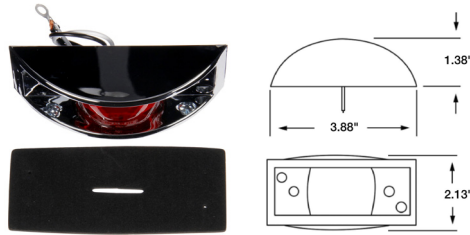

**SIGNAL-STAT, RAIL MOUNT,
LED, 2" X 3" RECTANGULAR**

FEATURES

- Narrow rail deflector mount
- Chrome plated ABS plastic bezel
- Mounting pad included
- Unique LED array displays full pattern output
- LEDs have no filament, therefore are extremely resistant to shock and vibration
- LEDs have less current draw, resulting in increased battery and alternator life while allowing more power for other vehicle requirements
- Epoxy-encapsulated electronics protect the lamp from damage caused by chemicals and moisture



LED

SIGNAL-STAT

Part Number	Lens Color	Lamp Connector	Plug Side 1	Plug Side 2	Volts	Amps	Diodes	Material	Lighting Codes
2671	Red	Hardwired	Hardwired	Ring Terminal Stripped End	12	0.05	4	AC	P2
2671A	Yellow	Hardwired	Hardwired	Ring Terminal Stripped End	12	0.05	4	AC	P2

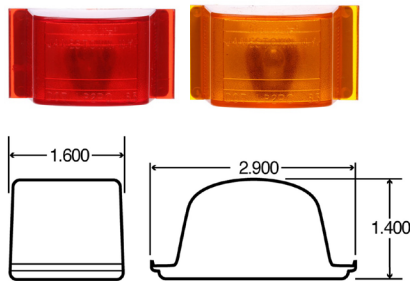

**12[®] SERIES, GROMMET MOUNT
INCANDESCENT, 2" X 3" RECTANGULAR**

FEATURES

- Standard replacement for UPS
- Sonically sealed lens and housing
- 15,000 rated 12V bulb life
- Suitable for PC requirements when mounted horizontally on a 45-degree angle
- Optional mounting gasket to improve seal between lamp and body



INCANDESCENT

12 SERIES

Part Number	Lens Color	Lamp Connector	Volts	Amps	Bulbs	Lighting Codes
12200R	Red	PL-10	12	0.33	1	P2 PC
12200Y	Yellow	PL-10	12	0.33	1	P2 PC
12201R	Red	PL-10	24	0.17	1	P2 PC
12201Y	Yellow	PL-10	24	0.17	1	P2 PC

12[®] SERIES, BRACKET MOUNT, INCANDESCENT, 2" X 3" RECTANGULAR, KIT



FEATURES

- High-impact plastic branch deflector mount
- Snap-in lamp design for easy replacement
- SAE PC-rated for combination clearance/marker applications
- Standard replacement on UPS models
- 1 Bulb

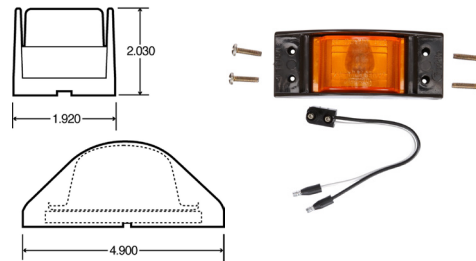

Part Number	Lens Color	Mount Color	Lamp Connector	Plug Side 1	Plug Side 2	Volts	Amps	Lighting Codes	Kit Includes
12001R	Red	Brown	PL-10	PL-10	.156 Bullet	12	0.33	P2 PC	12200R light, 94850 plug, gaskets 97921, 97925, 12724 brakcket KIT
12001Y	Yellow	Brown	PL-10	PL-10	.156 Bullet	12	0.33	P2 PC	12200Y light, 94850 plug, gaskets 97921, 97925, 12724 brakcket KIT
12003R	Red	Gray	PL-10	PL-10	Ring Terminal/ Stripped End	12	0.33	P2 PC	12200R light, 12723 bracket, 94919 plug, gaskets: 97921, 97925 KIT
12003Y	Yellow	Gray	PL-10	PL-10	Ring Terminal/ Stripped End	12	0.33	P2 PC	12200Y light, 12723 bracket, 94919 plug, gaskets: 97921, 97925 KIT

14 SERIES, REFLECTORIZED, GROMMET MOUNT, INCANDESCENT, 2" X 3" REC.



FEATURES

- Sonically sealed lens and housing
- Features snap-in lamp with reflector
- Long-life, 15,000-hour ,12 volt bulb
- Grommets flush-mount the lamp to vehicle
- Not suitable for PC requirements

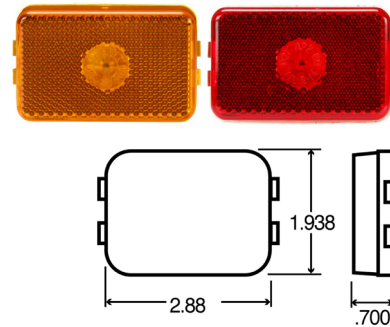

Part Number	Lens Color	Lamp Connector	Volts	Amps	Bulbs	Lighting Codes
14200R	Red	PL-10	12	0.33	1	A P2
14200Y	Yellow	PL-10	12	0.33	1	A P2

SIGNAL-STAT, 1 STUD INCANDESCENT, 2" X 3" REC.



FEATURES

- Shock/Mount for maximum bulb life
- Serves as legal reflector when mounted between 15 and 60 inches from ground level on trailers less than 80" wide

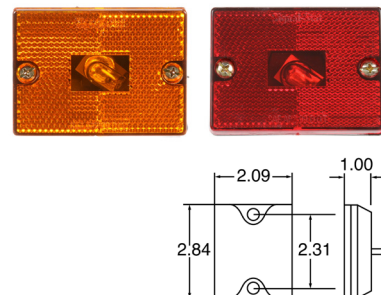

Part Number	Lens Color	Lamp Connector	Plug Side 1	Plug Side 2	Volts	Amps	Bulb	Material	Lighting Codes
1570	Red	Hardwired	Hardwired	Stripped End	12	0.33	1	AC	A P2
1570A	Yellow	Hardwired	Hardwired	Stripped End	12	0.33	1	AC	A P2

INCANDESCENT

12 SERIES

INCANDESCENT

14 SERIES

INCANDESCENT

12 SERIES

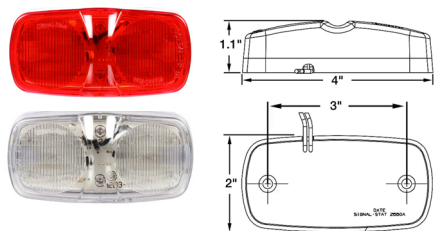

**SIGNAL-STAT, HARDWIRED,
2 SCREW, LED, 2" X 4" REC.**

FEATURES

- Hardwired design eliminates pin corrosion
- Encapsulated electronics
- 16 diode double bullseye LED pattern
- Unique combination of colored LEDs with clear lens draws attention to the lamp only when lit on 2661 and 2661A



Part Number	Lens Color	Lamp Connector	Plug Side 1	Plug Side 2	Volts	Amps	Diodes	Material	Lighting Codes
2660	Red	Hardwired	Hardwired	Blunt Cut	12	0.08	16	PC	P2
2660A	Yellow	Hardwired	Hardwired	Blunt Cut	12	0.08	16	PC	P2
2661	Clear / Red	Hardwired	Hardwired	Blunt Cut	12	0.08	16	PC	P2
2661A	Clear / Yellow	Hardwired	Hardwired	Blunt Cut	12	0.08	16	PC	P2

LED

SIGNAL-STAT

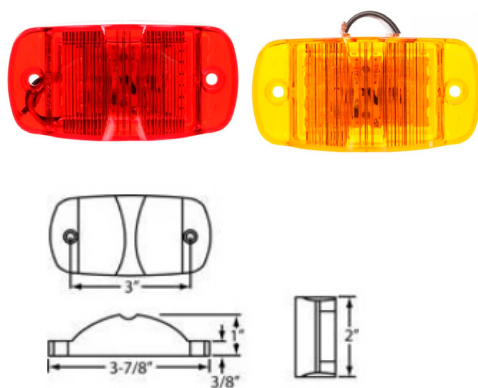

**SIGNAL-STAT, HARDWIRED,
2 SCREW, LED, 2" X 4" REC.**

FEATURES

- SAE PC-rated for combination clearance/marker applications
- Fits standard 3" mounting holes
- Unique LED array displays full pattern output



Part Number	Lens Color	Lamp Connector	Plug Side 1	Plug Side 2	Volts	Amps	Diodes	Material	Lighting Codes
2674	Red	Hardwired	Hardwired	Stripped End	12	0.07	8	PC	P2 PC
2674A	Yellow	Hardwired	Hardwired	Stripped End	12	0.07	8	PC	P2 PC

LED

SIGNAL-STAT

13 SERIES, BOLT & NUT MOUNT INCANDESCENT, 2" X 4" REC. ECE



FEATURES

- Sonically sealed lens and housing protect a heavy-duty, shock-mounted, single-filament bulb
- High-impact polycarbonate construction
- Functions include front outline marker (clear), ABS warning (green), end outline marker (red) and side marker (yellow)

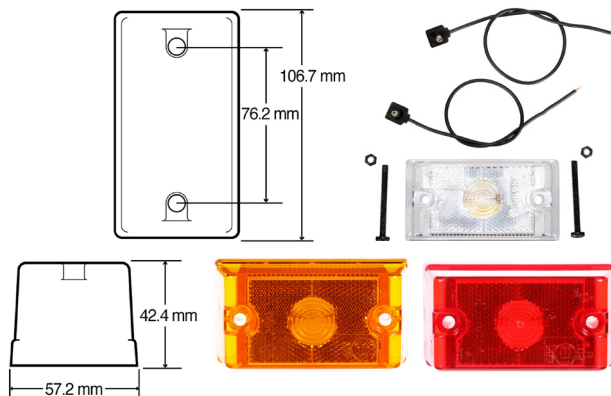

Part Number	Lens Color	Mount Color	Lamp Connector	Plug Side 1	Plug Side 2	Volts	Amps	Bulbs	Lighting Codes	Kit Includes
13200C	Clear	Clear	Super 21 Plug	—	—	24	0.35	1	E1	—
13001C	Clear	White	Super 21 Plug	Super 21 Plug	Stripped End	24	0.35	1	E1	13200C light, 96930 plug
13200R	Red	Red	Super 21 Plug	—	—	24	0.35	1	E1	—
13001R	Red	Red	Super 21 Plug	Super 21 Plug	Stripped End	24	0.35	1	E1	13200R light, 96930 plug
13200Y	Yellow	Yellow	Super 21 Plug	—	—	24	0.35	1	E1	—
13001Y	Yellow	Yellow	Super 21 Plug	Super 21 Plug	Stripped End	24	0.35	1	E1	13200Y light, 96930 plug
13001G	Green	Green	Super 21 Plug	Super 21 Plug	Stripped End	24	0.35	1	E1	13200G light, 96930 plug
13210R	Red	Red	Super 21 Plug	—	—	12	0.69	1	E1	—
13210Y	Yellow	Yellow	Super 21 Plug	—	—	12	0.69	1	E1	—
13210C	Clear	Clear	Super 21 Plug	—	—	12	0.69	1	E1	—
13011C	Clear	Clear	Super 21 Plug	Super 21 Plug	Stripped End	12	0.69	1	E1	13210C light, 95911 hardware, 96930 plug
13011R	Red	Red	Super 21 Plug	Super 21 Plug	Stripped End	12	0.69	1	E1	13210C light, 95911 hardware, 96930 plug
13011Y	Yellow	Yellow	Super 21 Plug	Super 21 Plug	Stripped End	12	0.69	1	E1	13210C light, 95911 hardware, 96930 plug

Ⓚ

Ⓚ

Ⓚ

Ⓚ

Ⓚ

Ⓚ

Ⓚ

26 SERIES, 2 SCREW, INCANDESCENT, 2" X 4" RECTANGULAR



FEATURES

- High-impact Permastat housing protects against rust and corrosion
- Shock/Mount (1213 model) for maximum bulb life
- Snap-on lens makes bulb and lens replacement easy
- Two bulb design-if one burns out, the other remains lighted

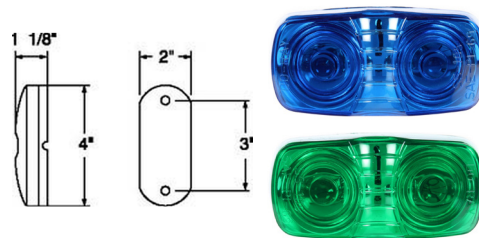

Part Number	Lens Color	Lamp Connector	Plug Side 1	Plug Side 2	Volts	Amps	Bulbs	Material	Diamond Shell	Lighting Codes
26302B	Blue	Hardwired	Hardwired	Stripped End	12	0.27	2	AC	No	
26302G	Green	Hardwired	Hardwired	Stripped End	12	0.27	2	AC	No	P2 PC

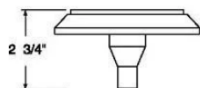
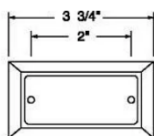

**SIGNAL-STAT, 2 SCREW
INCANDESCENT, 2" X 4" REC.**

FEATURES

- Chrome plated ABS housing
- Two wired
- Flush Mount



Part Number	Lens Color	Lamp Connector	Plug Side 1	Plug Side 2	Volts	Amps	Bulb	Material	Lighting Codes
1571	Red	Hardwired	Hardwired	Stripped End	12	0.27	1	AC	P2
1571A	Yellow	Hardwired	Hardwired	Stripped End	12	0.33	1	AC	P2

INCANDESCENT

SIGNAL-STAT

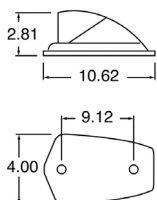

**SIGNAL-STAT, 2 SCREW,
INCANDESCENT, 2" X 4", REC.**

FEATURES

- Shock/Mount for maximum bulb life
- High-impact Permatat housing, chrome finish
- Modern rectangular styling improves appearance and reduces wind resistance
- Triple plated chrome finish
- Versatile installation - mounts on flat or slightly curved surface without disassembly
- Thick Neoprene mounting pad seals out dirt and moisture



Part Number	Lens Color	Lamp Connector	Plug Side 1	Plug Side 2	Volts	Amps	Bulb	Material	Lighting Codes
1350A	Yellow	Hardwired	Hardwired	Stripped End	12	0.35	1	PC	P2 PC

INCANDESCENT

SIGNAL-STAT

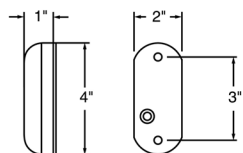

**SIGNAL-STAT, BRACKET MOUNT,
INCANDESCENT, 2" X 4" REC. KIT**

FEATURES

- Die cast base with heavy mounting pad
- Shock/Mount for maximum bulb life
- Rubber O-ring secures Snap-On lens
- Two bulb design-if one burns out, the other remains lighted
- Lamp meets requirements with only one bulb



Part Number	Lens Color	Lamp Connector	Plug Side 1	Plug Side 2	Volts	Amps	Bulb	Material	Lighting Codes	Kit Includes
1203	Red	Hardwired	Hardwired	Blunt Cut	12	0.33	2	AC	P2	9007 lens, 26782 base
1203A	Yellow	Hardwired	Hardwired	Blunt Cut	12	0.33	2	AC	P2	9007 lens, 26782 base

KIT

KIT

INCANDESCENT

SIGNAL-STAT

SIGNAL-STAT, 2 SCREW, INCANDESCENT, 2" X 4" REC.

INCANDESCENT

SIGNAL-STAT



FEATURES

- High-impact Permastat housing protects against rust and corrosion
- Shock/Mount (1213 model) for maximum bulb life
- Snap-on lens makes bulb and lens replacement easy
- Two bulb design-if one burns out, the other remains lighted
- Lamp meets requirements with only one bulb
- Not suitable for PC requirements

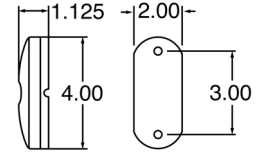

Part Number	Lens Color	Lamp Connector	Plug Side 1	Plug Side 2	Volts	Amps	Bulb	Material	Lighting Codes
1211	Red	Hardwired	Hardwired	Blunt Cut	12	0.27	2	AC	P2
1211A	Yellow	Hardwired	Hardwired	Blunt Cut	12	0.27	2	AC	P2
1213	Red	Hardwired	Hardwired	Blunt Cut	12	0.35	2	AC	P2
1213A	Yellow	Hardwired	Hardwired	Blunt Cut	12	0.35	2	AC	P2

SIGNAL-STAT, REFLECTORIZED, 2 SCREW, INCANDESCENT, 2" X 4" REC.

INCANDESCENT

SIGNAL-STAT



FEATURES

- For use on flat and lowboy trailers, recreational vehicles and boat trailers
- SAE Class A reflex reflector Snap-On lens
- Serves as a legal reflector when mounted between 15 and 60 inches from ground level on trailers less than 80" wide
- Two bulb design - if one burns out, the other remains lighted

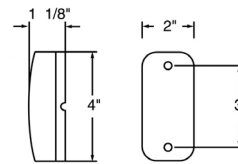

Part Number	Lens Color	Lamp Connector	Plug Side 1	Plug Side 2	Volts	Amps	Bulb	Material	Lighting Codes
1222	Red	Hardwired	Hardwired	Stripped End	12	0.27	2	AC	A P2
1222A	Yellow	Hardwired	Hardwired	Stripped End	12	0.27	2	AC	A P2

18[®] SERIES, REFLECTORIZED, 2 SCREW BRACKET MOUNT LED, 2" X 5" RECTANGULAR

LED

18 SERIES



FEATURES

- Complies with SAE J592 and J594 when mounted horizontally
- Brackets utilize standard military color scheme
- Complies with SAE J592 when mounted horizontally between 0 degrees to 34 degrees rollback
- Omnivolt Technology (12 or 24 volt systems will run without adjustment)
- LED life surpasses the 2,000 hours of incandescent bulbs by nearly 50x
- Lens and housing assemblies constructed of impact-resistant polycarbonate
- All electronics fully sealed in epoxy, making lamps less susceptible to shock and vibration
- Faster start-up times and low current draw

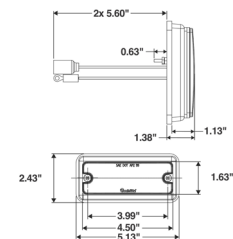

Part Number	Lens Color	Mount Color	Lamp Connector	Plug Side 1	Plug Side 2	Volts	Amps	Diodes	Lighting Codes
18085R	Red	Green	Hardwired	Hardwired	Female Military Boot/Ring Terminal	12 24	0.05	3	A P2
18085Y	Yellow	Green	Hardwired	Hardwired	Female Military Boot/Ring Terminal	12 24	0.05	3	A P2
18088R	Red	Tan	Hardwired	Hardwired	Female Military Boot/Ring Terminal	12 24	0.03	3	A P2
18088Y	Yellow	Tan	Hardwired	Hardwired	Female Military Boot/Ring Terminal	12 24	0.03	3	A P2

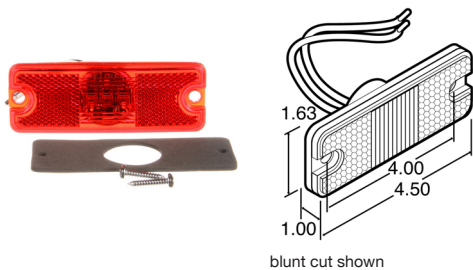

18[®] SERIES, REFLECTORIZED, 2 SCREW, LED, 2" X 5" REC. KIT

FEATURES

- Uses standard mounting holes and accessories
- Draws less current, allowing more power for other vehicle requirements
- OmniVolt versions also meet ECE standards
- Not suitable for PC requirements
- OmniVolt versions address increasing vehicle power demands by operating equally in electrical systems ranging from 10 to 30 volts
- Meets SAE J592e standards
- Meets SAE J594f when mounted with no rollout or rollback (18011C/R/Y & 18050R/Y)
- Kits contain sealing gasket and mounting hardware



Part Number	Lens Color	Mount Color	Lamp Connector	Plug Side 1	Plug Side 2	Volts	Amps	Diodes	Lighting Codes	
18060R	Red	Red	Hardwired	Hardwired	Packard 12010973	12	0.05	3	A P2	(KIT)
18060Y	Yellow	Yellow	Hardwired	Hardwired	Packard 12010973	12	0.05	3	A P2	(KIT)
18070R	Red	Red	Hardwired	Hardwired	Weather 12010972	12	0.05	3	A P2	(KIT)
18070Y	Yellow	Yellow	Hardwired	Hardwired	Weather 12010972	12	0.05	3	A P2	(KIT)



diamond shell
diamond shell

Part Number	Lens Color	Mount Color	Lamp Connector	Plug Side 1	Plug Side 2	Volts	Amps	Diodes	Lighting Codes	
18011C	Clear	Clear	Hardwired	Hardwired	Blunt Cut	12 24	0.02	3	E1	(KIT)
18011R	Red	Red	Hardwired	Hardwired	Blunt Cut	12 24	0.02	3	A P2	(KIT)
18011Y	Yellow	Yellow	Hardwired	Hardwired	Blunt Cut	12 24	0.02	3	A P2	(KIT)
18050R	Red	Red	Hardwired	Hardwired	Blunt Cut	12	0.05	3	A P2	(KIT)
18050Y	Yellow	Yellow	Hardwired	Hardwired	Blunt Cut	12	0.05	3	A P2	(KIT)
18090R	Red	Red	Hardwired	Hardwired	Blunt Cut	12	0.05	3	A P2	(KIT)
18090Y	Yellow	Yellow	Hardwired	Hardwired	Blunt Cut	12	0.05	3	A P2	(KIT)

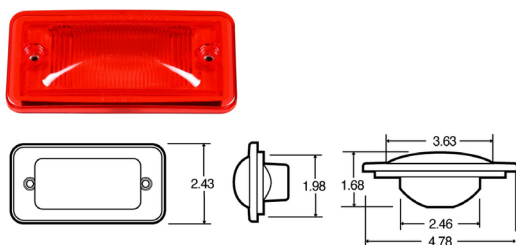

25 SERIES, 2 SCREW, LED, 2" X 5" RECTANGULAR

FEATURES

- Feature unique lens design for applications requiring a surface mount combination lamp
- Mounting gasket included to improve seal between lamp and vehicle
- Suitable for PC requirements when mounted on a 45-degree angle
- This is a lens only



Part Number	Lens Color	Mount Color	Lamp Connector	Lighting Codes
25784R	Red	Red	Socket Assembly	P2 PC
25784Y	Yellow	Yellow	Socket Assembly	P2 PC

25 SERIES, HARDWIRED
2 SCREW, LED, 2" X 5" REC.



FEATURES

- Hermetically sealed lens and housing
- Electronics completely sealed in epoxy to resist corrosion and moisture
- Less susceptible to shock and vibration
- Draws less current, allowing more power for other vehicle requirements
- Direct pin-to-circuit board solders assure vibration-resistant contacts

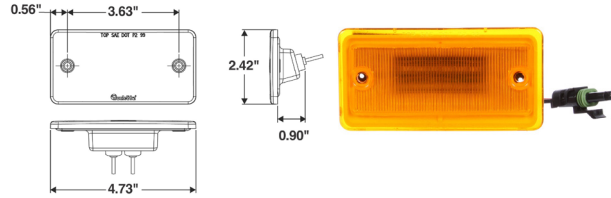

Part Number	Lens Color	Lamp Connector	Plug Side 1	Plug Side 2	Volts	Amps	Diodes	Material	Lighting Codes	Kit Components
25256Y	Yellow	Hardwired	Hardwired	PE Connector	12	0.12	6	AC	P2 PC	97701 gasket

diamond shell



25 SERIES, HARDWIRED, 2 SCREW
SURFACE MOUNT, LED, 2" X 5" REC.



FEATURES

- 25750Y features hardwired connections with optional field installable butt-splice connectors
- Hermetically sealed lens and housing
- Electronics completely sealed in epoxy to resist corrosion and moisture
- Less susceptible to shock and vibration
- Draws less current, allowing more power for other vehicle requirements
- Direct pin-to-circuit board solders assure vibration resistant contacts
- Includes 97701 mounting gasket with #25250R/Y and 25750Y
- 25750Y is legal when mounted 0 to 40 degree rollback from vertical

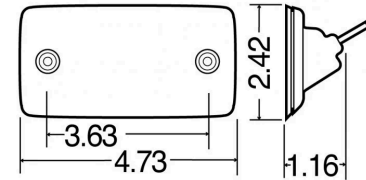

Part Number	Lens Color	Mount Color	Mount Type	Lamp Connector	Plug Side 1	Plug Side 2	Volts	Amps	Diodes	Lighting Codes
25750Y	Yellow	Yellow	Flush	Hardwired	Hardwired	Stripped End	12	0.1	3	P2
25250R	Red	Red	Surface	Hardwired	Hardwired	Stripped End	12	0.1	3	P2
25250Y	Yellow	Yellow	Surface	Hardwired	Hardwired	Stripped End	12	0.1	3	P2

25[®] SERIES, INCANDESCENT,
REFLECTORIZED, 2 SCREW,
SOCKET ASSEMBLY, RECTANGULAR



FEATURES

- Features design for replacement on Mack trucks
- Sonically sealed lens and housing
- Mounting gasket included to improve seal of lamp and body
- Recommend Truck-Lite's #94940 plug and #194 bulb
- Not suitable for PC requirements
- Upgrade #25765Y to LED using part #25750Y
- Upgrade #25766R/Y to LED using part #25250R/Y

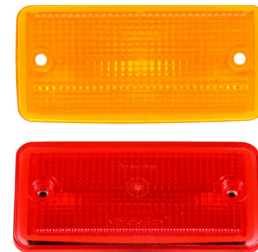
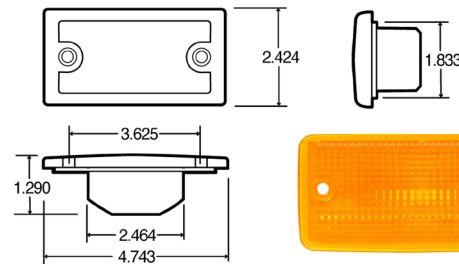

Part Number	Lens Color	Mount Color	Mount Type	Lamp Connector	Lighting Codes
25765Y	Yellow	Yellow	Flush	Socket Assembly	P2
25766R	Red	Red	Surface	Socket Assembly	P2
25766Y	Yellow	Yellow	Surface	Socket Assembly	P2

LED

25 SERIES

LED

25 SERIES

INCANDESCENT

25 SERIES

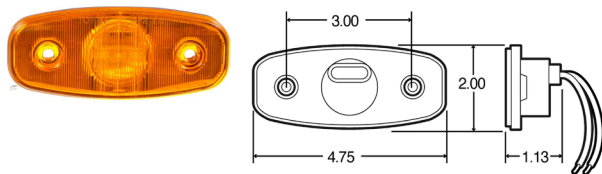

26 SERIES, HARDWIRED 2 SCREW, LED, 2" X 5" RECTANGULAR

FEATURES

- Popular in trailer and body applications
- Hardwired design with blunt cut or molded bullet ends
- Innovative optics design allows for horizontal or vertical mounting
- Not suitable for PC requirements



Part Number	Lens Color	Mount Color	Lamp Connector	Plug Side 1	Plug Side 2	Volts	Amps	Diodes	Lighting Codes
26250R	Red	Red	Hardwired	Hardwired	.180 Bullet	12	0.05	3	P2
26250Y	Yellow	Yellow	Hardwired	Hardwired	.180 Bullet	12	0.05	3	P2
26251R	Red	Red	Hardwired	Hardwired	Blunt Cut	12	0.05	3	P2
26251Y	Yellow	Yellow	Hardwired	Hardwired	Blunt Cut	12	0.05	3	P2

LED
26 SERIES

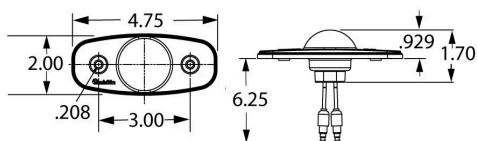

26 SERIES, HARDWIRED 2 SCREW, LED, 2" X 5" REC. KIT

FEATURES

- Unique dome lens design
- Popular in trailer and body applications
- Hard wired design with molded .180 bullet ends
- Innovative optics design allows for horizontal mounting
- LEDs have no filament, therefore are not susceptible to shock and vibration
- Not suitable for PC requirements
- Will meet with 30 degree roll back and 6 degree roll out



Part Number	Lens Color	Mount Color	Lamp Connector	Plug Side 1	Plug Side 2	Volts	Amps	Diodes	Lighting Codes	Kit Includes
26270R	Red	Red	Hardwired	Hardwired	.180 Bullet	12	0.05	3	P2	97073 gasket
26270Y	Yellow	Yellow	Hardwired	Hardwired	.180 Bullet	12	0.05	3	P2	97073 gasket

LED
26 SERIES

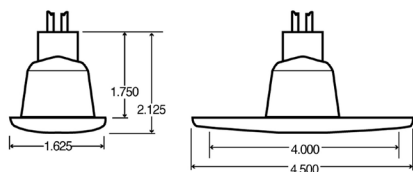
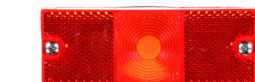

18[®] SERIES, REFLECTORIZED, 2 SCREW, INCAN. 2" X 5" REC. KIT

FEATURES

- Sonically welded lens and housing
- Replaceable bulb
- Not suitable for PC requirements
- Replaces Signal-Stat 1572/1572A



Part Number	Lens Color	Mount Color	Lamp Connector	Plug Side 1	Plug Side 2	Volts	Amps	Bulbs	Lighting Codes	Kit Includes
18300R	Red	Red	Socket Assembly	Socket Assembly	Ring Terminal/Stripped End	12	0.27	1	A P2	99012R light, 97927 gasket, 94940 plug
18300Y	Yellow	Yellow	Socket Assembly	Socket Assembly	Ring Terminal/Stripped End	12	0.27	1	A P2	99012Y light, 97927 gasket, 94940 plug

LED
18 SERIES

26 SERIES, BRACKET MOUNT

INCANDESCENT, 2" X 5" REC. KIT



FEATURES

- Surface mounts on two screws at 1.5" centers
- Ground-through base
- Heavy-duty steel and acrylic construction
- Lens attaches to base with one center screw
- Optional zinc-plated steel guard provides additional protection

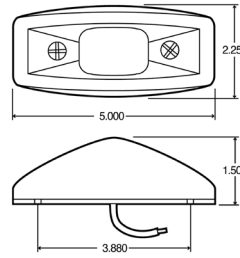

26313R

Part Number	Lens Color	Mount Color	Lamp Connector	Plug Side 2	Volts	Amps	Bulbs	Lighting Codes	Kit Includes
26311R	Red	Silver/ Die cast	Hardwired	Stripped End	12	0.35	1	P2 PC	99160r lens
26311Y	Yellow	Silver/ Die cast	Hardwired	Stripped End	12	0.35	1	P2 PC	99160y lens
26313R	Red	Silver/ ABS	Hardwired	Stripped End	12	0.35	2	P2 PC	99160r lens
26313Y	Yellow	Silver/ ABS	Hardwired	Stripped End	12	0.35	2	P2 PC	99160y lens



26 SERIES, BRACKET MOUNT

2" X 5", INCANDESCENT, REC. KIT



FEATURES

- Surface mounts on two screws at 1.5" centers
- Acrylic lens construction, uses a #168 bulb
- Optional zinc-plated steel guard provides additional protection

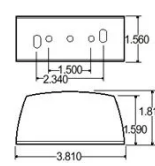

Part Number	Lens Color	Lamp Connector	Plug Side 2	Volts	Amps	Bulbs	Lighting Codes	Kit Includes
26353R	Red	Hardwired	Stripped End	12	0.35	1	P2 PC	99170r lens
26353Y	Yellow	Hardwired	Stripped End	12	0.35	1	P2 PC	99170y lens



26 SERIES, BRACKET MOUNT

ARMORED, INCANDESCENT, 2" X 5" REC. KIT



FEATURES

- Surface mounts on two screws at 1.5" centers
- Heavy-duty steel and acrylic construction
- Optional zinc-plated steel guard provides additional protection

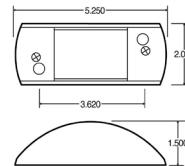

Part Number	Lens Color	Mount Color	Lamp Connector	Plug Side 1	Plug Side 2	Volts	Amps	Bulbs	Lighting Codes	Kit Includes
26315R	Red	Silver	Hardwired	Hardwired	Stripped End	12	0.27	1	P2 PC	8930 lens, 1895 bulb
26315Y	Yellow	Silver	Hardwired	Hardwired	Stripped End	12	0.27	1	P2 PC	8930a lens, 1895 bulb



21® SERIES, HARDWIRED

2 SCREW, LED, 2" X 6" REC.



FEATURES

- Popular replacement on Freightliner vehicles where lamp is not mounted on a curved location
- Electronics completely sealed in epoxy to resist corrosion and moisture
- Less susceptible to shock and vibration
- LED lamps offer superior brightness and faster start time than incandescent versions

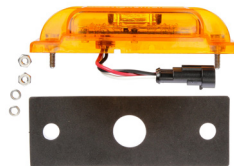
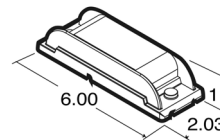

Part Number	Lens/Mount Color	Harness Length	Lamp Connector	Plug Side 2	Volts	Freightliner Number	Diodes	Lighting Codes
21093Y	Yellow	41" Turn Only	Hardwired	3 Position Connector	12	-	16	P2 PC
21090Y	Yellow	59" Harness	Hardwired	AMP 282105-1	12	A06-27561-002	16	P2 PC
21091Y	Yellow	41" Marker/Turn with hole grommet	Hardwired	AMP 282105-1	12	A06-27561-003	16	P2 PC
21092Y	Yellow	41" Turn Only	Hardwired	AMP 282105-1	12	A06-27584-003	16	P2 PC
21094Y	Yellow	14" Marker/Turn	Hardwired	AMP 282105-1	12	A06-27561-000	16	P2 PC
21095Y	Yellow	13" Turn Only	Hardwired	AMP 282105-1	12	A06-27584-003, A06-27584-001	16	P2 PC
21096Y	Yellow	-	Hardwired	AMP 282105-1	12	-	16	P2 PC

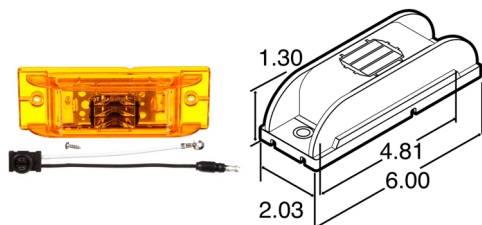

21[®] SERIES, NON-REFLECTORIZED 2 SCREW, LED, 2" X 6" REC. KIT

FEATURES

- Innovative optic design allows one PC rated lamp the ability to function as two
- Draws less current, allowing more power for other vehicle requirements
- Uses standard mounting holes and accessories
- Standard lamps have 3-diode pattern
- PC rated lamps have 8-diode pattern



Part Number	Lens Color	Mount Color	Lamp Connector	Plug Side 1	Plug Side 2	Volts	Amps	Diodes	Lighting Codes	Kit Includes
21075R	Red	Red	Fit 'N Forget M/C	Fit 'N Forget M/C	.180 Bullet/Ring Terminal	12	0.1	8	P2 PC	21275R light, 94862 plug
21075Y	Yellow	Yellow	Fit 'N Forget M/C	Fit 'N Forget M/C	.180 Bullet/Ring Terminal	12	0.1	8	P2 PC	21275Y light, 94862 plug

LED
21 SERIES

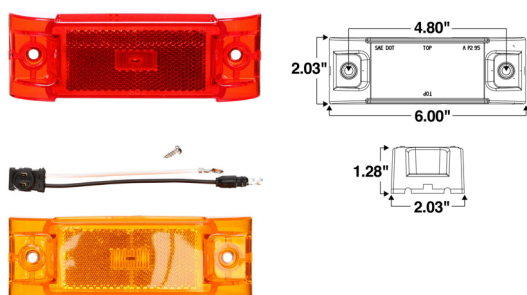

21[®] SERIES, REFLECTORIZED 2 SCREW, LED, 2" X 6" RECTANGULAR

FEATURES

- Draws less current, allowing more power for other vehicle requirements
- Uses standard mounting holes and accessories



Part Number	Lens Color	Lamp Connector	Plug Side 1	Plug Side 2	Volts	Amps	Diodes	Diamond Shell	Lighting Codes	Kit Includes
21251R	Red	Fit 'N Forget M/C	—	—	12	0.1	1	No	A P2	—
21051R	Red	Fit 'N Forget M/C	Fit 'N Forget M/C	.180 Bullet/Ring Terminal	12	0.1	1	No	A P2	21251R lamp, 94862 plug
21251Y	Yellow	Fit 'N Forget M/C	—	—	12	0.1	2	No	A P2	—
21051Y	Yellow	Fit 'N Forget M/C	Fit 'N Forget M/C	.180 Bullet/Ring Terminal	12	0.1	2	No	A P2	21251Y lamp, 94862 plug
21256R	Red	Fit 'N Forget M/C	—	—	24	0.05	3	No	A P2	—
21056R	Red	Fit 'N Forget M/C	Fit 'N Forget M/C	.180 Bullet/Ring Terminal	24	0.05	3	No	A P2	21256R lamp, 94862 plug
21256Y	Yellow	Fit 'N Forget M/C	—	—	24	0.05	3	No	A P2	—
21056Y	Yellow	Fit 'N Forget M/C	Fit 'N Forget M/C	.180 Bullet/Ring Terminal	24	0.05	3	No	A P2	21256Y lamp, 94862 plug
21880R	Red	Fit 'N Forget M/C	—	—	12	0.1	1	Yes	A P2	—
21080R	Red	Fit 'N Forget M/C	Fit 'N Forget M/C	.180 Bullet/Ring Terminal	12	0.1	1	Yes	A P2	21880R lamp, 94862 plug
21880Y	Yellow	Fit 'N Forget M/C	—	—	12	0.1	2	Yes	A P2	—
21080Y	Yellow	Fit 'N Forget M/C	Fit 'N Forget M/C	.180 Bullet/Ring Terminal	12	0.1	2	Yes	A P2	21880Y leamp, 94862 plug

LED
21 SERIES

LED

21 SERIES

21[®] SERIES, 2 SCREW LED, 2" X 6" RECTANGULAR



FEATURES

- Innovative optic design allows one PC rated lamp the ability to function as two
- Draws less current, allowing more power for other vehicle requirements
- Uses standard mounting holes and accessories
- PC rated lamps have 8-diode pattern

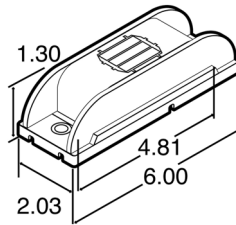

Part Number	Lens Color	Mount Color	Lamp Connector	Volts	Amps	Diodes	Lighting Codes
21275R	Red	Red	Fit 'N Forget M/C	12	0.1	8	P2 PC
21275Y	Yellow	Yellow	Fit 'N Forget M/C	12	0.1	8	P2 PC

LED

SIGNAL-STAT

SIGNAL-STAT, 2 SCREW LED, 2" X 6" RECTANGULAR



FEATURES

- Unique combination of colored LEDs with clear lens draws attention to the lamp only when lit
- Optional mounting & sealing gaskets available to improve seal between lamps
- Less susceptible to shock & vibration

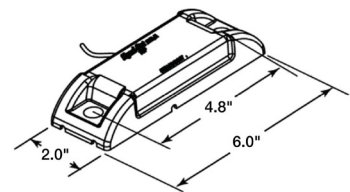

Part Number	Lens Color	Lamp Connector	Volts	Amps	Diodes	Lighting Codes
2152	Clear Red	Hardwired	12	0.12	8	P2
2152A	Clear Yellow	Hardwired	12	0.12	8	P2

LED

SIGNAL-STAT

SIGNAL-STAT, REFLECTORIZED 2 SCREW, LED, 2" X 6" REC.



FEATURES

- Popular on camping, motorcycle, horse and utility trailers
- Kit provides all legal lamps and reflective products for trailer less than 80 inches wide
- Solid-state LED lamps offer greater resistance from damage due to vibration
- Rugged plastic design prevents corrosion

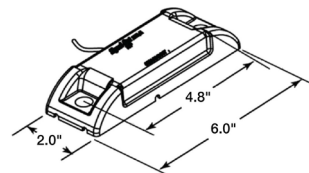

Part Number	Lens Color	Lamp Connector	Volts	Amps	Diodes	Lighting Codes
2150	Red	Hardwired	12	0.12	8	A P2
2150A	Yellow	Hardwired	12	0.12	8	A P2

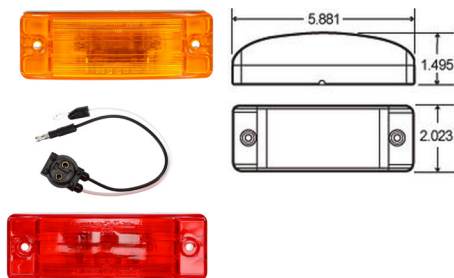

21[®] SERIES, 2 SCREW, INCANDESCENT, 2" X 6" REC.



FEATURES

- Available with standard or reflectorized lens
- Features male pin connections
- Suitable for PC requirements on a 45-degree angle with additional reflectors

Part Number	Lens Color	Mount Color	Lamp Connector	Plug Side 1	Plug Side 2	Volts	Amps	Bulbs	Lighting Codes	Kit Includes
29202R	Red	Red	Male Pin	—	—	12	0.33	2	P2 PC	—
29002R	Red	Red	Male Pin	Male Pin	.180 Bullet/Ring Terminal	12	0.33	2	P2 PC	29202R light, 96106 plug
29202Y	Yellow	Yellow	Male Pin	—	—	12	0.33	2	P2 PC	—
29002Y	Yellow	Yellow	Male Pin	Male Pin	.180 Bullet/Ring Terminal	12	0.33	2	P2 PC	29202Y light, 96106 plug

INCANDESCENT

21 SERIES

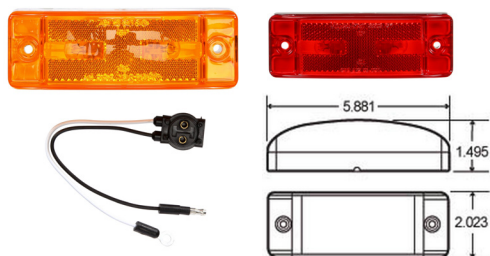

21[®] SERIES, REFLECTORIZED, 2 SCREW, INCAN. 2" X 6" RECTANGULAR



FEATURES

- Available with standard or reflectorized lens
- Features male pin connections
- Suitable for PC requirements on a 45-degree angle with additional reflectors

Part Number	Lens Color	Mount Color	Lamp Connector	Plug Side 1	Plug Side 2	Volts	Amps	Bulbs	Lighting Codes	Kit Includes
29203R	Red	Red	Male Pin	—	—	12	0.33	2	A P2 PC	—
29003R	Red	Red	Male Pin	Male Pin	.180 Bullet/Ring Terminal	12	0.33	2	A P2 PC	29203R light, 96106 plug
29203Y	Yellow	Yellow	Male Pin	—	—	12	0.33	2	A P2 PC	—
29003Y	Yellow	Yellow	Male Pin	Male Pin	.180 Bullet/Ring Terminal	12	0.33	2	A P2 PC	29203Y light, 96106 plug

INCANDESCENT

21 SERIES

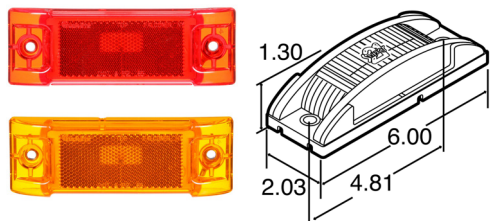

SUPER 21[®] SERIES, REFLECTORIZED, 2 SCREW, INCAN. 2" X 6" RECTANGULAR



FEATURES

- Available with standard or reflectorized lens
- Suitable for PC requirements on a 45-degree angle with additional reflectors
- Version available for ABS requirements
- Optional gaskets available to improve seal between lamp and body
- Kits with extension brackets are a direct replacement for Utility Trailer #03-5100-0-097/8

Part Number	Lens Color	Mount Color	Lamp Connector	Volts	Amps	Bulbs	Lighting Codes
21201R	Red	Red	Super 21 Plug	12	0.33	1	A P2
21201Y	Yellow	Yellow	Super 21 Plug	12	0.33	1	A P2

INCANDESCENT

21 SERIES

SUPER 21[®] SERIES, 2 SCREW INCANDESCENT, 2" X 6" RECTANGULAR



FEATURES

- Available with standard or reflectorized lens
- Suitable for PC requirements on a 45-degree angle with additional reflectors
- Optional gaskets available to improve seal between lamp and body
- Kits with extension brackets are a direct replacement for Utility Trailer #03-5100-0-097/8

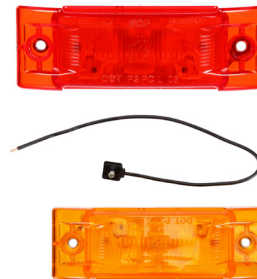
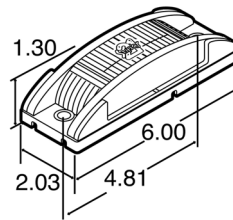

INCANDESCENT

SUPER 21 SERIES

Part Number	Lens Color	Mount Color	Lamp Connector	Plug Side 1	Plug Side 2	Volts	Amps	Bulbs	Lighting Codes	Kit Includes
21200R	Red	Red	Super 21 Plug	—	—	12	0.33	1	P2 PC	—
21001R	Red	Red	Super 21 Plug	Super 21 Plug	Stripped End	12	0.17	1	P2 PC	21200R light, 96930 plug (KIT)
21200Y	Yellow	Yellow	Super 21 Plug	—	—	12	0.33	1	P2 PC	—
21001Y	Yellow	Yellow	Super 21 Plug	Super 21 Plug	Stripped End	12	0.17	1	P2 PC	21200Y light, 96930 plug (KIT)
21205R	Red	Red	Super 21 Plug	—	—	24	0.17	1	P2 PC	—
21005R	Red	Red	Super 21 Plug	Super 21 Plug	Stripped End	24	0.17	1	P2 PC	21205R light, 96930 plug (KIT)
21205Y	Yellow	Yellow	Super 21 Plug	—	—	24	0.17	1	P2 PC	—
21005Y	Yellow	Yellow	Super 21 Plug	Super 21 Plug	Stripped End	24	0.17	1	P2 PC	21205Y light, 96930 plug (KIT)
21506R	Red	Red	Self-Piercing Plug	—	—	12	0.33	1	P2 PC	—
21506Y	Yellow	Yellow	Self-Piercing Plug	—	—	12	0.33	1	P2 PC	—

SUPER 21[®] SERIES, 2 SCREW, ABS INCANDESCENT, 2" X 6" RECTANGULAR



FEATURES

- Available with standard or reflectorized lens
- Suitable for PC requirements on a 45-degree angle with additional reflectors
- Optional gaskets available to improve seal between lamp and body
- Kits with extension brackets are a direct replacement for Utility Trailer #03-5100-0-097/8

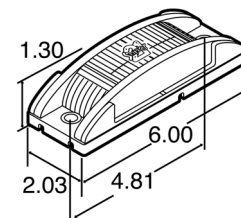

INCANDESCENT

SUPER 21 SERIES

Part Number	Lens Color	Mount Color	Lamp Connector	Volts	Amps	Bulbs	Lighting Codes
21210Y	Yellow	Yellow	Super 21 Plug	12	0.33	1	ABS

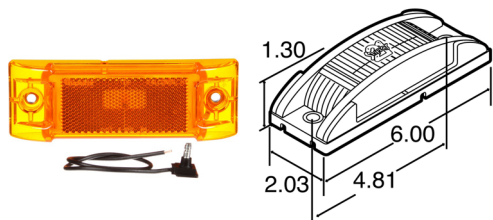

SUPER 21® SERIES, REFLECTORIZED 2 SCREW, INCANDESCENT, 2" X 6" REC.

FEATURES

- Available with standard or reflectorized lens
- Suitable for PC requirements on a 45-degree angle with additional reflectors
- Version available for ABS requirements
- Optional gaskets available to improve seal between lamp and body
- Kits with extension brackets are a direct replacement for Utility Trailer #03-5100-0-097/8



Part Number	Lens Color	Mount Color	Lamp Connector	Plug Side 1	Plug Side 2	Volts	Amps	Bulbs	Lighting Codes	Kit Includes
21201R	Red	Red	Super 21 Plug	—	—	12	0.33	1	A P2	—
21002R	Red	Red	Super 21 Plug	Super 21 Plug	Stripped End	12	0.33	1	A P2	21201R light, 96930 plug (KIT)
21201Y	Yellow	Yellow	Super 21 Plug	—	—	12	0.33	1	A P2	—
21002Y	Yellow	Yellow	Super 21 Plug	Super 21 Plug	Stripped End	12	0.33	1	A P2	21201Y light, 96930 plug (KIT)

INCANDESCENT

SUPER 21 SERIES

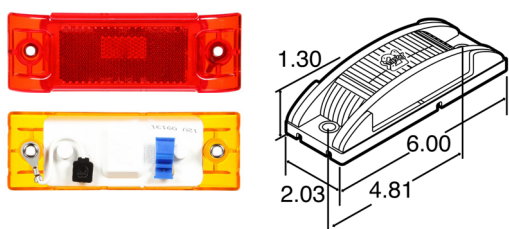

SUPER 21® SERIES, REFLECTORIZED, SELF-PIERCING PLUG 2 SCREW, INCANDESCENT, 2" X 6" REC.

FEATURES

- Available with standard or reflectorized lens.
- Suitable for PC requirements on a 45-degree angle with additional reflectors.
- Version available for ABS requirements.
- Optional gaskets available to improve seal between lamp and body.
- Kits with extension brackets are a direct replacement for Utility Trailer #03-5100-0-097/8



Part Number	Lens Color	Mount Color	Lamp Connector	Volts	Amps	Bulbs	Lighting Codes	Included Parts
21507R	Red	Red	Self-Piercing Plug	12	0.33	1	A P2	21201R light (KIT)
21507Y	Yellow	Yellow	Self-Piercing Plug	12	0.33	1	A P2	21201Y light (KIT)

INCANDESCENT

SUPER 21 SERIES

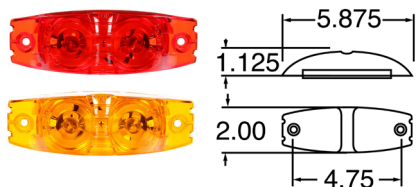

SIGNAL-STAT, 2 SCREW INCANDESCENT, 2" X 6" REC.

FEATURES

- Polycarbonate lens for total protection against tree branches
- External mounting holes save installation time
- Two bulb design - if one burns out, the other remains lighted



Part Number	Lens Color	Lamp Connector	Volts	Amps	Bulbs	Lighting Codes
1233	Red	Hardwired	12	0.33	2	P2
1233A	Yellow	Hardwired	12	0.33	2	P2

INCANDESCENT

SIGNAL-STAT

INCANDESCENT

SIGNAL-STAT, 2 SCREW, 1"X4" OVAL, INCANDESCENT



FEATURES

- Ideal for narrow rail or channel mounted applications
- Can be mounted vertically or horizontally
- Low profile Snap-On lens allows for easy bulb replacement
- Acrylic lens, ABS base
- SAE PC rated for combination clearance/marker application

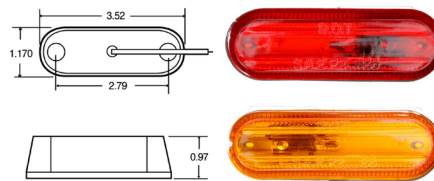

SIGNAL-STAT

Part Number	Lens Color	Lamp Connector	Volts	Amps	Bulb	Lighting Codes
1555	Red	Hardwired	12	0.27	1	P2 PC
1555A	Yellow	Hardwired	12	0.27	1	P2 PC

INCANDESCENT

26 SERIES, 2 SCREW, 2" X 4", OVAL, INCANDESCENT



FEATURES

- Innovative lamp design allows one lamp the ability to function as two
- Lamp is designed to comply with SAE J2042 requirements when mounted both horizontally and vertically
- Newly designed wire grommet provides improved water resistance between the lamp and wiring
- Polycarbonate lens offers added impact and heat resistance
- Part# 26310R&Y have rubber housing to protect against shock and vibration using #99051R/Y lens
- Part# 26313R&Y feature a snap on lens for quick bulb replacement. 99050R/Y lens
- All part#s use 194 bulb

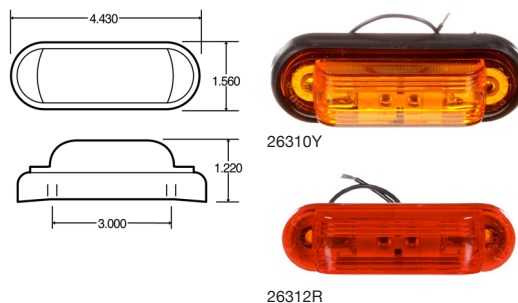

26 SERIES

Part Number	Lens Color	Mount Color	Lamp Connector	Plug Side 1	Plug Side 2	Volts	Amps	Bulbs	Lighting Codes
26310R	Red	Black	Hardwired	Hardwired	Stripped End	12	0.27	2	P2
26310Y	Yellow	Black	Hardwired	Hardwired	Stripped End	12	0.27	2	P2
26312R	Red	Red	Hardwired	Hardwired	Stripped End	12	0.27	2	P2
26312Y	Yellow	Yellow	Hardwired	Hardwired	Stripped End	12	0.27	2	P2

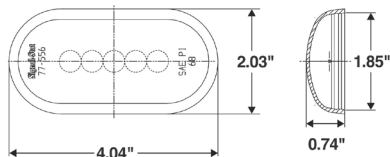

SIGNAL-STAT, BRACKET MOUNT 2"X4" OVAL, INCANDESCENT

FEATURES

- High impact polycarbonate housing protects against rust and corrosion
- Snap-on lens permits easy bulb and lens replacement
- Two bulb design - if one burns out, the other remains lighted
- Optional mounting gasket available to improve seal between lamp and body
- Bulb Replaceable



Part Number	Lens Color	Lamp Connector	Plug Side 1	Plug Side 2	Volts	Amps	Bulb	Material	Lighting Codes	Kit Includes
1259B	Blue	Hardwired	—	—	12	0.27	2	AC	Auxiliary	—
1259G	Green	Hardwired	—	—	12	0.27	2	AC	Auxiliary	—
1259	Red	Hardwired	Hardwired	Stripped End	12	0.27	2	AC	P2	9093 lens, 26781 base
1259A	Yellow	Hardwired	Hardwired	Stripped End	12	0.27	2	AC	P2	9093A lens, 26781 base



INCANDESCENT

SIGNAL-STAT

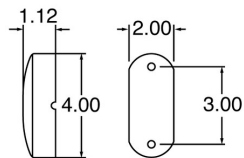

SIGNAL-STAT, REFLECTORIZED, BRACKET MOUNT, 2"X4" OVAL, INCANDESCENT, KIT

FEATURES

- For use on flat and lowboy trailers, recreational vehicles and boat trailers
- High impact polycarbonate housing protects against rust and corrosion
- Serves as legal reflector when mounted between 15" and 60" from ground level on trailers less than 80" wide
- Two bulb design-if one burns out, the other remains lighted



Part Number	Lens Color	Lamp Connector	Plug Side 1	Plug Side 2	Volts	Amps	Diodes	Lighting Codes	Kit Includes
1264	Red	Hardwired	Hardwired	Stripped End	12	0.33	2	A P2	8933 lens, 9522 pad
1264A	Yellow	Hardwired	Hardwired	Stripped End	12	0.33	2	A P2	8933A lens, 9522 pad



INCANDESCENT

SIGNAL-STAT

**SIGNAL-STAT, 2 SCREW,
1"X4" TRIANGULAR, INCANDESCENT, KIT**

INCANDESCENT

SIGNAL-STAT



FEATURES

- U-Haul and Stoughton Trailer replacement lamp
- HT suffix versions have .180" bullet terminal
- Snap-on lens for easy bulb and lens replacement
- Surface mounted, slim styling
- Shock/Mount for maximum bulb life
- Permastat base will not rust

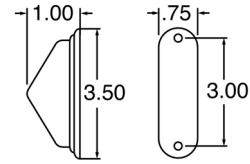

Part Number	Lens Color	Lamp Connector	Plug Side 1	Plug Side 2	Volts	Amps	Diodes	Lighting Codes	Kit Includes
1520AHT	Yellow	Hardwired	Hardwired	.180 Bullet	12	0.27	1	P2 PC	9082a lens
1520HT	Red	Hardwired	Hardwired	.180 Bullet	12	0.27	1	P2 PC	9082 lens

(KIT)

(KIT)

**26 SERIES, 2 SCREW,
1" X5", TRIANGLE, INCANDESCENT**

INCANDESCENT

26 SERIES



FEATURES

- Features single screw lens mounting for quick installation and bulb replacement
- Contoured rubber mount provides additional shock protection
- Suitable for PC requirements on a 45-degree angle

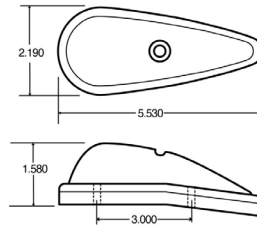

Part Number	Lens Color	Lamp Connector	Plug Side 1	Plug Side 2	Volts	Amps	Bulbs	Lighting Codes
26765R	Red	Socket Assembly	Socket Assembly	Stripped End	12	0.59	1	P2 PC
26765Y	Yellow	Socket Assembly	Socket Assembly	Stripped End	12	0.59	1	P2 PC

**SIGNAL-STAT, 2 SCREW
1"X5" TRIANGULAR, INCANDESCENT**

INCANDESCENT

SIGNAL-STAT



FEATURES

- High-impact polycarbonate, gray finish, protects against rust and corrosion
- Versatile installation- mounts on flat or slightly curved surface
- Thick neoprene pad seals out dirt & moisture
- Hardwired design

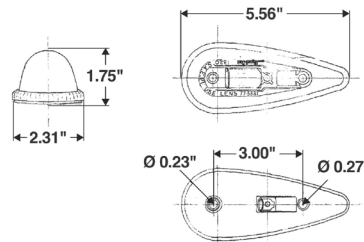

Part Number	Lens Color	Lamp Connector	Volts	Amps	Diodes	Lighting Codes
1320A	Yellow	Socket Assembly	12	0.59	1	P2

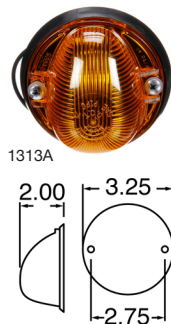

1312A

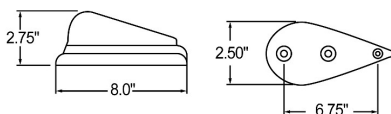

SIGNAL-STAT, 2 SCREW 2"X3" TRIANGULAR, INCANDESCENT

FEATURES

- One-piece chrome die cast housing
- Includes Neoprene mounting pad to cushion lamp for long bulb life
- Fits securely on all flat or slightly curved surfaces
- Single retaining screw holds lens in place



Part Number	Lens Color	Lamp Connector	Volts	Amps	Diodes	Lighting Codes
1312A	Red	Hardwired	12	0.59	1	P2
1313A	Yellow	Hardwired	12	0.35	1	P2

INCANDESCENT

SIGNAL-STAT

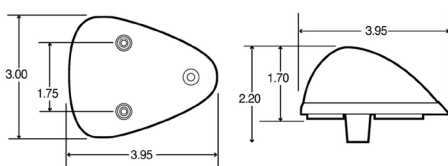

25[®] SERIES, 2 STUD MOUNT, 3" X 4" TRIANGLE, INCANDESCENT

FEATURES

- Aerodynamic design for replacement on Ford trucks #F81B-15442-A
- Screw-on polycarbonate lens and housing
- Mounts on 1-3/4" centers with foam gasket seal and M5 mounting studs
- Kit includes #95119 plug assembly to connect socket (mating to AMP 174928-1)
- Suitable for PC requirements on a 45-degree angle



Part Number	Lens Color	Lamp Connector	Plug Side 1	Plug Side 2	Volts	Amps	Bulbs	Lighting Codes	Kit Includes
25762Y	Yellow	AMP 174928-1	—	—	12	0.27	1	P2 PC	—
25062Y	Yellow	AMP 174921-1	AMP 174928-1	Stripped End	12	0.27	1	P2 PC	25762Y light, 95119 plug



INCANDESCENT

25 SERIES



26354Y

26771R

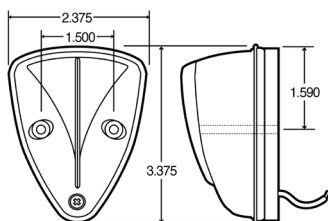

26 SERIES, 2 SCREW, 3" X 4", TRIANGLE, INCANDESCENT

FEATURES

- Surface mounts on two pass-through lens screws at 1.5" centers
- Ground-through base
- Popular for use on school buses and commercial vehicles
- Heavy-duty steel and acrylic construction
- Lens attaches to base with one screw
- Optional zinc-plated steel guard provides additional protection



Part Number	Lens Color	Lamp Connector	Plug Side 1	Plug Side 2	Volts	Amps	Bulbs	Lighting Codes
26354R	Red	Hardwired	Hardwired	Stripped End	12	0.69	1	P2 PC
26354Y	Yellow	Hardwired	Hardwired	Stripped End	12	0.69	1	P2 PC
26771R	Red	Hardwired	Hardwired	Stripped End	12	0.69	1	P2 PC
26771Y	Yellow	Hardwired	Hardwired	Stripped End	12	0.69	1	P2 PC

INCANDESCENT

26 SERIES

INCANDESCENT

SIGNAL-STAT, 2 SCREW
3"X4" TRIANGULAR, INCANDESCENT



FEATURES

- Popular school bus lamp
- Galvanized steel housing
- Adaptable for front, side, and rear mounting
- Single lens screw for easy bulb replacement
- Includes cell sponge mounting pad for curved surfaces

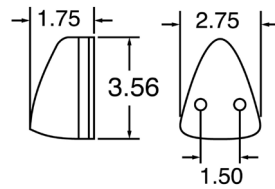

SIGNAL-STAT

Part Number	Lens Color	Lamp Connector	Volts	Amps	Diodes	Lighting Codes
1150	Red	Hardwired	12	0.33	1	P2 PC
1150A	Yellow	Hardwired	12	0.33	1	P2 PC

LED

SIGNAL-STAT, 2 SCREW
3"X4" TRIANGULAR, LED



FEATURES

- 13 diode pattern
- Hard-wired design
- Suitable for PC requirements when mounted on a 45 degree angle

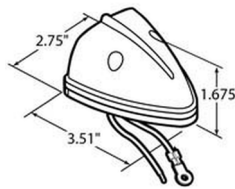

SIGNAL-STAT

Part Number	Lens Color	Lamp Connector	Volts	Amps	Diodes	Lighting Codes
1155	Red	Hardwired	12	0.12	13	P2 PC
1155A	Yellow	Hardwired	12	0.12	13	P2 PC

INCANDESCENT

25[®] SERIES, 2 SCREW,
3" X 6" TRIANGULAR, INCANDESCENT



FEATURES

- Features surface mount design for replacement on many Ford trucks
- Contains #94940 plug assembly and one #194 wedge base bulb
- Lens and housing are sonically sealed
- Suitable for PC requirements on a 45-angle
- Replaces Signal-Stat 1360A

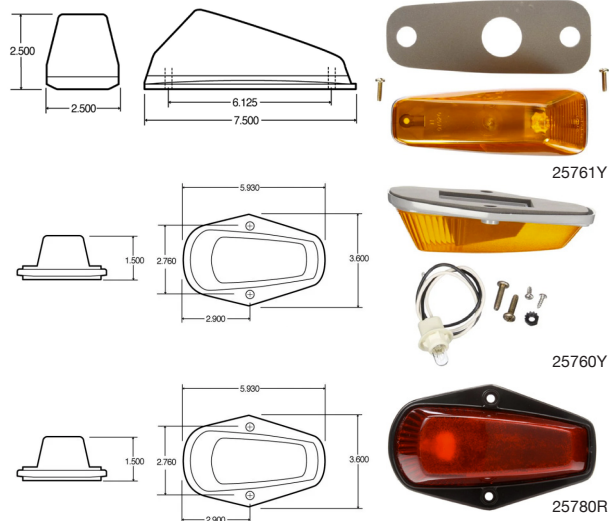

25 SERIES

Part Number	Lens Color	Mount Color	Lamp Connector	Plug Side 1	Plug Side 2	Volts	Amps	Bulbs	Lighting Codes
25760Y	Yellow	Gray	Socket Assembly	Socket Assembly	Ring Terminal/ Stripped End	12	0.27	1	P2
25761Y	Yellow	Gray	Socket Assembly	Socket Assembly	Ring Terminal/ Stripped End	12	0.27	1	P2
25780R	Red	Black	Socket Assembly	Socket Assembly	2 Position .180 Bullet Terminal	12	0.27	1	P2 PC

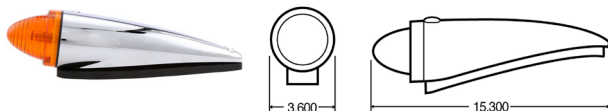

26 SERIES, 2 SCREW, 1", BEEHIVE, INCANDESCENT, KIT

FEATURES

- Features chrome-plated plastic housing with contour base and rubber mounting pad
- Includes one #67 bulb



Part Number	Lens Color	Mount Color	Lamp Connector	Plug Side 1	Plug Side 2	Volts	Amps	Bulbs	Lighting Codes	Kit Includes
26760Y	Yellow	Silver	Hardwired	Hardwired	Ring Terminal/ Stripped End	12	0.35	1	P2	99066Y lens, 97046 pad, 97905 grommet

KIT

INCANDESCENT

26 SERIES

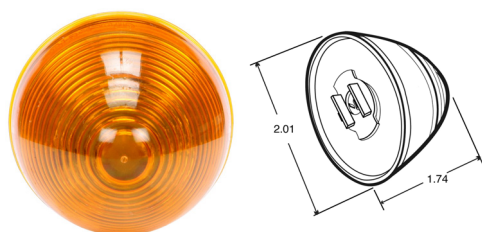

30[®] SERIES, GROMMET MOUNT, 2" ROUND, LED, BEEHIVE

FEATURES

- Popular replacement for cab marker or corner trailer applications
- LEDs have no filament, therefore are not susceptible to shock and vibration
- Meets SAE 592e standards
- Less current draw, resulting in increased battery and alternator life while allowing more power for other vehicle requirements
- Red lamp has 2 diode pattern and Yellow lamp has 5 diode pattern



Part Number	Lens Color	Lamp Connector	Volts	Amps	Diodes	Lighting Codes
30276R	Red	Fit 'N Forget M/C	12	0.05	2	P2 PC
30276Y	Yellow	Fit 'N Forget M/C	12	0.05	5	P2 PC

LED

30 SERIES

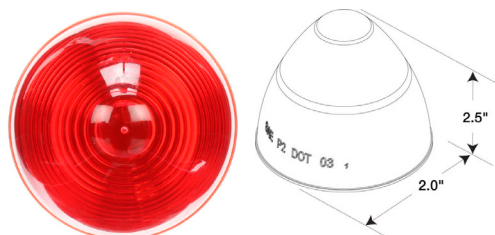

SIGNAL-STAT, GROMMET MOUNT, 2" ROUND, LED, BEEHIVE

FEATURES

- Popular replacement for cab marker or corner trailer applications
- Unique combination of colored LEDs with clear lens draws attention to the lamp only when lit on 3076 and 3076A
- Not recommended for use with cam on mounts or PC applications



Part Number	Lens Color	Lamp Connector	Volts	Amps	Diodes	Lighting Codes
3075	Red	PL-10	12	0.1	6	P2
3075A	Yellow	PL-10	12	0.1	6	P2
3076	Clear Red	PL-10	12	0.1	6	P2
3076A	Clear Yellow	PL-10	12	0.1	6	P2

LED

SIGNAL-STAT

30[®] SERIES, GROMMET MOUNT, 2" ROUND, INCANDESCENT, BEEHIVE

INCANDESCENT

30 SERIES



FEATURES

- Features a beehive lens designed for cab marker use
- Lens and housing are sonically sealed
- High impact polycarbonate construction
- 12, volt 15,000-hour-rated bulb
- Suitable for PC requirements on a 45 angle

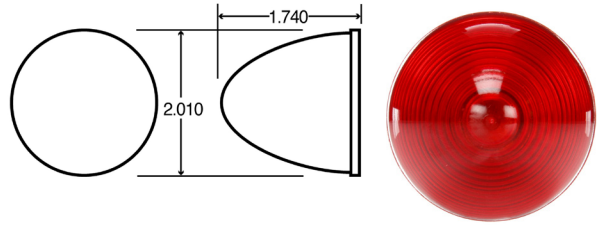

Part Number	Lens Color	Lamp Connector	Volts	Amps	Bulbs	Lighting Codes
30201R	Red	PL-10	12	0.33	1	P2 PC
30201Y	Yellow	PL-10	12	0.33	1	P2 PC

SIGNAL-STAT, INCANDESCENT, 2" ROUND, BRACKET MOUNT, BEEHIVE

INCANDESCENT

30 SERIES



FEATURES

- High-impact acrylic housing protects against rust and corrosion
- Rigid right angle bracket
- Snap-on lens allows simple bulb
- Hardwired design eliminates pin corrosion

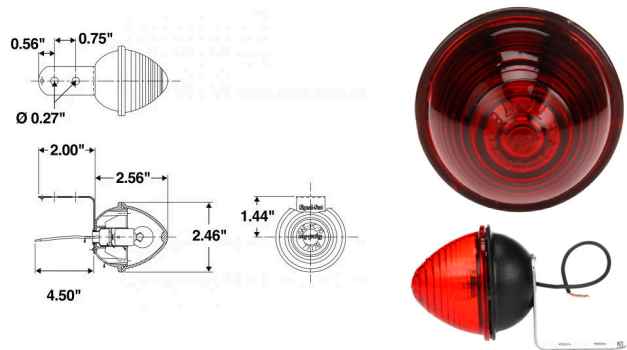

Part Number	Lens Color	Lamp Connector	Plug Side 1	Plug Side 2	Volts	Amps	Bulbs	Lighting Codes
1001A	Yellow	Hardwired	Hardwired	Stripped End	12	0.59	1	P2 PC

SIGNAL-STAT, GROMMET MOUNT LED, 2.5" BEEHIVE

LED

SIGNAL-STAT



FEATURES

- Popular replacement for cab marker or corner trailer applications
- Standard PL-10 connection
- Unique combination of colored LEDs with clear lens draws attention to the lamp only when lit on 1076, and 1076A
- Not recommended for use with cam-on mounts or PC applications

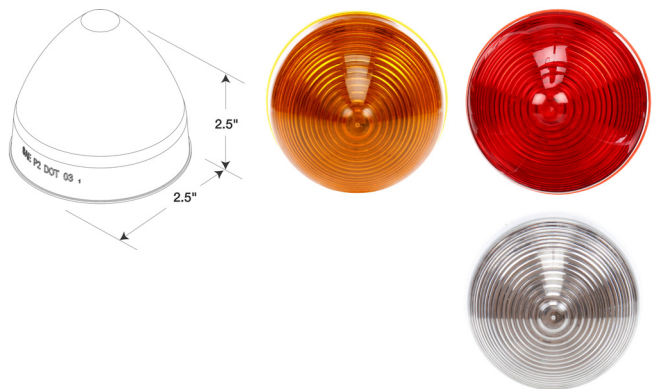

Part Number	Lens Color	Lamp Connector	Volts	Amps	Diodes	Lighting Codes
1076	Clear Red	PL-10	12	0.1	6	P2
1076A	Clear Yellow	PL-10	12	0.1	6	P2
1075	Red	PL-10	12	0.1	6	P2
1075A	Yellow	PL-10	12	0.1	6	P2

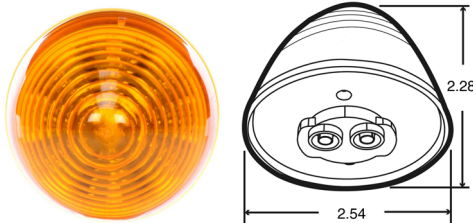

10[®] SERIES, GROMMET MOUNT, 2.5" ROUND, LED, BEEHIVE

FEATURES

- Popular replacement for cab marker or corner trailer applications
- Meets SAE 592E standards
- Less current draw, resulting in increased battery and alternator life while allowing more power for other vehicle requirements
- LEDs have no filament, therefore are not susceptible to shock and vibration
- Not recommended for use with cam-on mounts
- Polycarbonate lens



Part Number	Lens Color	Lamp Connector	Volts	Amps	Diodes	Lighting Codes
10276R	Red	PL-10	12	0.05	8	P2
10276Y	Yellow	PL-10	12	0.05	8	P2

LED
10 SERIES

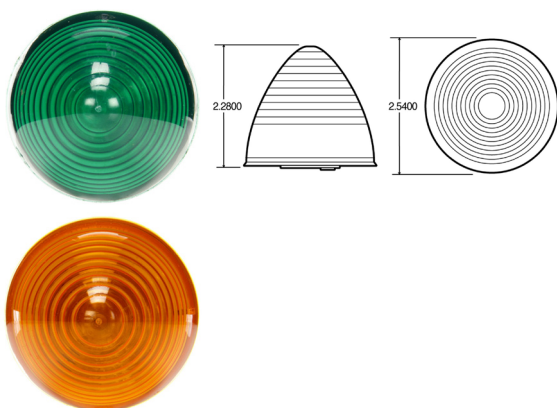

10[®] SERIES, INCANDESCENT, 2.5" ROUND, GROMMET MOUNT, BEEHIVE

FEATURES

- Features a beehive lens designed for cab marker use
- Lens and housing are sonically sealed
- High impact polycarbonate construction
- 12 volt, 15,000-hour-rated bulb
- Suitable for PC requirements on a 45-degree angle in mounting devices #10708, #10720, #00801, #00803, or #00804
- Upgrade to LED use Truck-Lite part no. 10276R/Y or Signal-Stat part no. 1075/1075A



Part Number	Lens Color	Lamp Connector	Volts	Amps	Bulbs	Lighting Codes
10203B	Blue	PL-10	12	0.33	1	Auxiliary
10203G	Green	PL-10	12	0.33	1	Auxiliary
10203R	Red	PL-10	12	0.33	1	P2 P3 PC
10203Y	Yellow	PL-10	12	0.33	1	P2 P3 PC

INCANDESCENT

10 SERIES

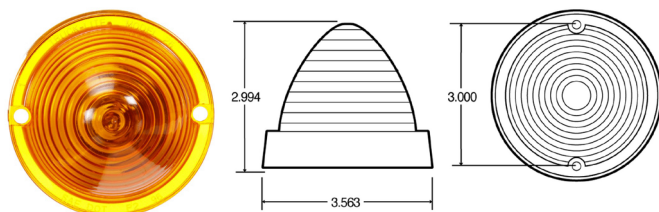

26 SERIES, 2 SCREW, 4" ROUND, INCANDESCENT, BEEHIVE

FEATURES

- Features a beehive lens designed for cab marker use
- Lens and housing are sonically sealed
- High impact polycarbonate construction



Part Number	Lens Color	Lamp Connector	Volts	Amps	Bulbs	Lighting Codes
26762Y	Yellow	PL-10	12	0.33	1	P2 PC

INCANDESCENT

26 SERIES

IDENTIFICATION BARS

Style	Mounting Type	Page
Light Assembly		156-157
	Grommet Mount	156
	Bracket Mount	156-157
ID Bar		158-161
	Grommet Mount	158
	4 Screw Bracket Mount	159-160
	2 Screw Bracket Mount	160
	Bracket Mount	161

LED

33[®] SERIES, GROMMET MOUNT, ID LIGHT ASSEMBLY, 0.75" ROUND, LED



FEATURES

- US patent #6612728
- World smallest LED marker lamp for the transportation industry
- Hardwired lamp design is easily retrofitted
- Requires 3/4" mounting hole

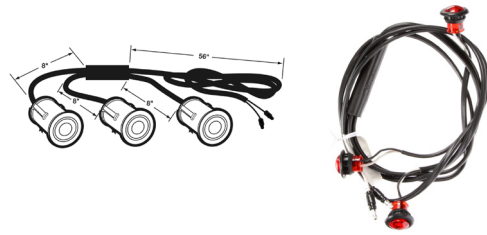

Part Number	Lens Color	Lamp Connector	Plug Side 1	Plug Side 2	Volts	Amps Major/Minor	Diodes	Mount Color	Standards Met
33740R	Red	Hardwired	Hardwired	.180 Bullet	12	0.05/0.20	3 sets of 1	Black	P2
33751R	Red	Hardwired	Hardwired	.180 Bullet/Female .180 Bullet	12	0.05/0.20	3 sets of 1	Black	P2

LED

35[®] SERIES, DUAL FUNCTION, BRACKET MOUNT, ID LIGHT ASSEMBLY, 1" X 4", LED, 3 LIGHTS



FEATURES

- Allows marker and clearance lamps to operate in two output levels
- Brighter lighting activated by the brake function
- Great for retrofitting existing lighting systems
- Provides added safety benefit to trailing drivers with additional braking awareness at a higher level on the vehicle notifying drivers more quickly of vehicle stops
- Internal electronics protect vehicle from electrical feedback
- Heavy-duty design allows for carefree maintenance
- Mating harness is required from Voltage regulator to Lamps

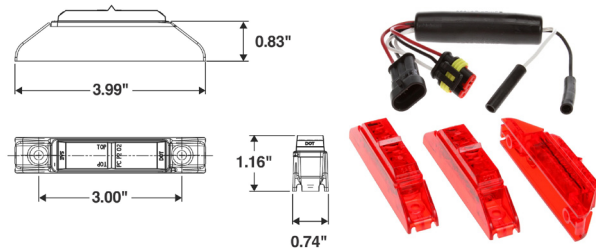

Part Number	Lens Color	Lamp Connector	Plug Side 1	Plug Side 2	Volts	Amps	Diodes	Mount Color	Standards Met	Kit Includes
35033R	Red	Fit 'N Forget M/C	No Plug	.180 Bullet/Female .180 Bullet	12	0.219/ 0.419	3 sets of 1	Red	P2	33375R lamps, 97340 regulator (KIT)
35035R	Red	Fit 'N Forget M/C	No Plug	Dual .180 Receptacles	12	0.219/ 0.419	3 sets of 1	Red	P2	33375R lamps, 97342 regulator, (KIT)

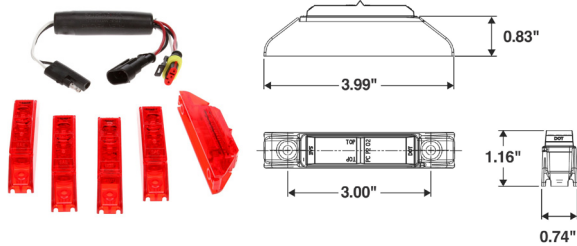

35[®] SERIES, DUAL FUNCTION, BRACKET MOUNT, ID LIGHT ASSEMBLY, 1" X 4", 5 LIGHTS

FEATURES

- Allows marker and clearance lamps to operate in two output levels
- Brighter lighting activated by the brake function
- Great for retrofitting existing lighting systems
- Provides added safety benefit to trailing drivers with additional braking awareness at a higher level on the vehicle notifying drivers more quickly of vehicle stops
- Internal electronics protect vehicle from electrical feedback
- Heavy-duty design allows for carefree maintenance
- Mating harness is required from Voltage regulator to Lamps



Part Number	Lens Color	Lamp Connector	Plug Side 1	Plug Side 2	Volts	Amps	Diodes	Mount Color	Standards Met	Kit Includes
35034R	Red	Fit 'N Forget M/C	No Plug	.180 Bullet/Female .180 Bullet	12	0.361/ 0.697	5 sets of 1	Red	P2	35375R Lamps, 97340 regulator
35036R	Red	Fit 'N Forget M/C	No Plug	Dual .180 Receptacles	12	0.361/ 0.697	5 sets of 1	Red	P2	35375R Lamps, 97342 regulator



Quick Tip: Plug Side 1 vs. Plug Side 2

When buying a plug for your light it's important to understand what type of connection mates with the light and what type of termination will mate with the power harness. Plug Side 1 refers to the side of the plug that mates directly to the light. Plug Side 2 refers to the end of the plug that will mate with the power source.



Keep Your Connections Safe. Don't Forget Your Dielectric Gel.

Dielectric gel protects your lights by protecting the points of contact between elements of your lighting and harness system. Our dielectric compounds prevent arcing and corrosion and keep your lights performing as they should.

You can find our dielectric products on page 498



15[®] SERIES, GROMMET MOUNT, ID BAR, 1" X 2", LED



FEATURES

- Designed to fit applications requiring minimal space
- Features stainless steel bar with three LED Model 15 lamps on 6" centers
- Electronics completely sealed in epoxy to resist corrosion and moisture
- Sonically sealed lens and housing
- Less susceptible to shock and vibration
- Draws less current, allowing more power for other vehicle requirements
- Direct pin-to-circuit board solders assure vibration-resistant contacts



RED



YELLOW

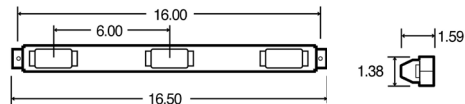

Part Number	Lens Color	Lamp Connector	Plug Side 1	Plug Side 2	Volts	Amps	Diodes	Center Distance	Standards Met	Kit Includes
15050R	Red	PL-10	PL-10	.180 Bullet/Ring Terminal	12	.210	3 sets of 1	6in	P2	15250R light, 00808 bar, 93943 harness
15050Y	Yellow	PL-10	PL-10	.180 Bullet/Ring Terminal	12	.210	3 sets of 1	6in	P2	15250Y light, 00808 bar, 93943 harness

Ⓚ

Ⓚ

35[®] SERIES, GROMMET MOUNT, ID BAR, 1" X 4" LED



FEATURES

- Designed to fit applications requiring minimal space
- Slim 1" width is perfect for upper rail mounting
- Draws less current, allowing more power for other vehicle requirements



RED



YELLOW

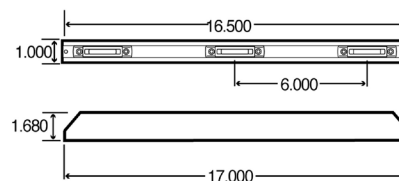

Part Number	Lens Color	Lamp Connector	Plug Side 1	Plug Side 2	Volts	Amps	Diodes	Standards Met	Center Distance	Kit Includes
35740R	Red	Fit 'N Forget M/C	Fit 'N Forget M/C	.180 Bullet/Ring Terminal	12	0.201	3 sets of 1	P2	6in	35200R light, 00815 bar, 96989 harness
35740Y	Yellow	Fit 'N Forget M/C	Fit 'N Forget M/C	.180 Bullet/Ring Terminal	12	0.201	3 sets of 2	P2	6in	35200Y light, 00815 bar, 96989 harness
35741R	Red	Fit 'N Forget M/C	Fit 'N Forget M/C	.180 Bullet/Ring Terminal	12	0.201	3 sets of 1	P2	9in	35200R light, 00816 bar, 96996 harness
35741Y	Yellow	Fit 'N Forget M/C	Fit 'N Forget M/C	.180 Bullet/Ring Terminal	12	0.201	3 sets of 2	P2	9in	35200Y light, 00816 bar, 96996 harness

Ⓚ

Ⓚ

Ⓚ

Ⓚ

LED

15 SERIES

LED

35 SERIES

10[®] SERIES, 4 SCREW BRACKET MOUNT, ID BAR, 2.5", INCANDESCENT

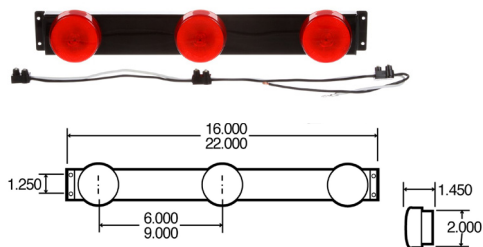

FEATURES

- Features rugged stainless steel or black enameled ID bar
- Lamps are mounted on 6" or 9" centers



Part Number	Lens Color	Lamp Connector	Plug Side 1	Plug Side 2	Volts	Amps	Bulbs	Center Distance	Standards Met	Kit Includes
10744R	Red	PL-10	PL-10	Stripped End/Ring Terminal	12	0.990	3 sets of 1	6in	P2	10202R light, 00815 bar, 96989 harness
10745R	Red	PL-10	PL-10	Stripped End/Ring Terminal	12	0.990	3 sets of 1	9in	P2	10202R light, 00719 bar, 93906 harness

(KIT)

(KIT)

INCANDESCENT

10 SERIES

15[®] SERIES, 4 SCREW BRACKET MOUNT, ID BAR, 2.5", INCANDESCENT

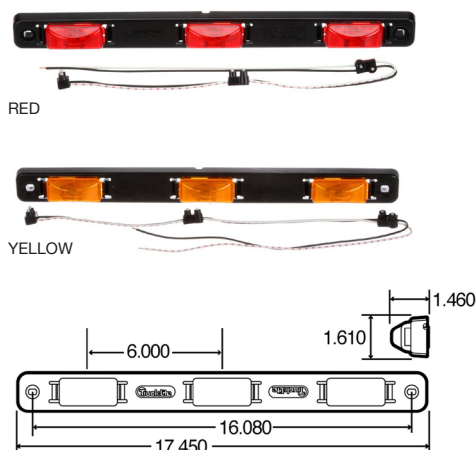

RED

YELLOW

FEATURES

- Features rugged stainless steel ID bar designed to fit in limited mounting areas
- Lamps are mounted on 6" centers
- Direct replacement for Ford
- Fits in most narrow header rails
- Snap-lock tabs allow easy installation



Part Number	Lens Color	Lamp Connector	Plug Side 2	Volts	Amps	Bulb	Mount Color	Center Distance	Standards Met	Kit Includes
15741R	Red	PL-10	.180 Bullet/Ring Terminal	12	0.990	3 sets of 1	Silver Stainless Steel	6in	P2	15200R light, 00808 bar, 93943 harness
15745R	Red	PL-10	Stripped End	12	0.990	3 sets of 1	Black Polycarbonate	6in	P2	10200R light, 00817 bar, 93906 harness
15745Y	Yellow	PL-10	Stripped End	12	0.990	3 sets of 1	Black Polycarbonate	6in	P2	15200Y light, 00817 bar, 93945 harness

(KIT)

(KIT)

(KIT)

INCANDESCENT

15 SERIES

30[®] SERIES, 4 SCREW BRACKET MOUNT, ID BAR, 2", INCANDESCENT

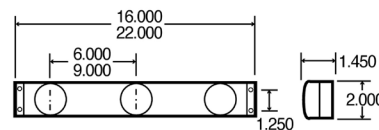

FEATURES

- Features rugged stainless steel or black enameled ID bar
- Lamps are mounted on 6" or 9" centers

Part Number	Lens Color	Lamp Connector	Plug Side 1	Plug Side 2	Volts	Amps	Bulb	Mount Color	Center Distance	Standards Met	Kit Includes
30740R	Red	PL-10	PL-10	Stripped End/Ring Terminal	12	0.990	3 sets of 1	Black	6in	P2	30200R light, 00798 bar, 93906 harness
30742R	Red	PL-10	PL-10	Stripped End/Ring Terminal	12	0.990	3 sets of 1	Black	9in	P2	30200R light, 00719 bar, 96996 harness



SIGNAL-STAT, 2 SCREW BRACKET MOUNT, ID BAR, 1"X 2", INCANDESCENT

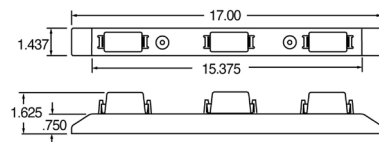

FEATURES

- Popular economy identification bar for light duty applications
- Acrylic lens and housing
- Coated polycarbonate bar

Part Number	Lens Color	Lamp Connector	Plug Side 1	Plug Side 2	Volts	Amp	Bulbs	Mount Color	Standards Met	Kit Includes
1508R	Red	Hardwired	Hardwired	Stripped End/Ring Terminal	12	0.900	3 sets of 1	White	P2	194 bulbs x3, 9342 lens x3



INCANDESCENT

30 SERIES

INCANDESCENT

SIGNAL-STAT

SIGNAL-STAT, BRACKET MOUNT, ID BAR, 2"X 4", INCANDESCENT



RED



AMBER

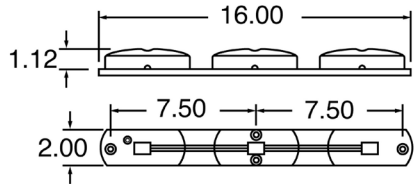

FEATURES

- Popular economy identification bar for light duty applications
- Acrylic lens and housing
- Coated polycarbonate bar



Part Number	Lens Color	Lamp Connector	Plug Side 1	Plug Side 2	Volts	Amps	Bulbs	Mount Color	Standards Met	Kit Includes
1215	Red	Hardwired	Hardwired	Stripped End	12	2.1	3 sets of 2	Black	P2	168 bulbs x6, 9007 lens x6
1216	Red	Hardwired	Hardwired	Stripped End	12	2.1	3 sets of 2	White	P2	168 bulbs x6, 9007 lens x6
1216A	Amber	Hardwired	Hardwired	Stripped End	12	2.1	3 sets of 2	White	P2	168 bulbs x6, 9007A lens x6



INCANDESCENT

SIGNAL-STAT

PERSONAL TRAILER KITS

Shape	Category	Page
SQUARE		164-165
	LED Trailer Kits	164-165
	Incandescent Trailer Lamps	165
RECTANGULAR		166-167
	Incandescent Trailer Kits	166-167
	Replacement Lamps	167

LED
SQUARE

LED, STOP/TURN/TAIL KIT, SQUARE

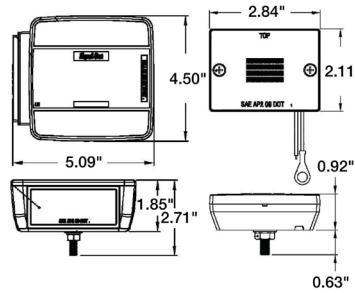

FEATURES

- Popular on camping, motorcycle, horse and utility trailers
- Kit provides all legal lamps and reflective products for trailer less than 80 inches wide
- Roadside lamp includes license plate lamp
- Solid-state LED lamps offer greater resistance from damage due to vibration
- Rugged plastic design prevents corrosion
- 12 diode stop, turn and tail lamp with 1 diode side marker lamp, 1 diode marker clearance lamp

Functions Include
Left Hand S/T/T, Right Hand S/T/T

Part Number	Position	Mount Type	Lamp Connection	Plug Side 1	Plug Side 2	Volts	Amps Major/Minor	Replacement Parts
5050DK	RH/LH	Bracket	Hardwired	Hardwired	Stripped End	12	0.16/0.05	5056 LH S/T, 5055 RH S/T

KIT

LED
SQUARE

LED, STOP/TURN/TAIL KIT, M/C INCLUDED, SQUARE

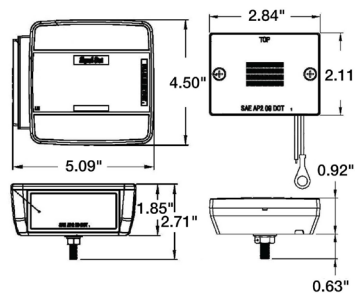

FEATURES

- Popular on camping, motorcycle, horse and utility trailers
- Kit provides all legal lamps and reflective products for trailer less than 80 inches wide
- Roadside lamp includes license plate lamp
- Solid-state LED lamps offer greater resistance from damage due to vibration
- Rugged plastic design prevents corrosion
- 12 diode stop, turn and tail lamp with 1 diode side marker lamp, 1 diode marker clearance lamp

Functions Include
Left Hand S/T/T/LP/SM/S Ref
Right Hand S/T/T/SM/S Ref
Left Hand M/C, Right Hand M/C

Part Number	Position	Mount Type	Lamp Connection	Plug Side 1	Plug Side 2	Volts	Amps Major/Minor	Replacement Parts
5051DK	RH/LH	Bracket	Hardwired	Hardwired	Stripped End	12	0.16/0.05	5055 RH S/T, 5056 LH S/T, 5052AD x2

KIT

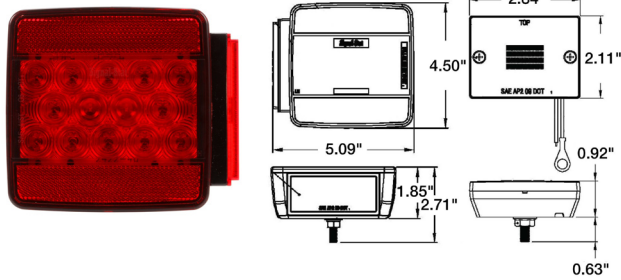

LED, SINGLE STOP/TURN/TAILO KIT 5\"/>



FEATURES

- Kit provides all legal lamps & reflective products for trailers less than 80" wide
- Popular on camping, motorcycle, horse & utility trailers

Part Number	Position	License Lamp	Lamp Connection	Plug Side 1	Plug Side 2	Lens Material	Volts	Amps Major/Minor
5055D	RH	No	Hardwired	Hardwired	Stripped End	AC	12	0.16/0.05
5056D	LH	No	Hardwired	Hardwired	Stripped End	AC	12	0.16/0.05

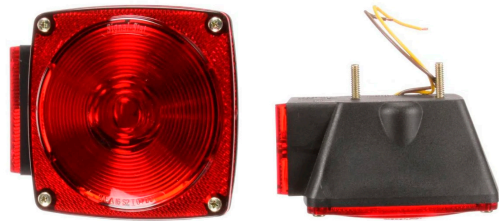

INCANDESCENT, SINGLE STOP/TURN/TAILO LAMP, 2 STUD



FEATURES

- For use on camping, motorcycle, horse and utility trailers
- Kit provides all legal lamps and reflective products for trailers less than 80" wide
- Special electrical connections eliminate external wiring splices
- Rugged plastic design prevents corrosion
- S/T/T Lamps mount on two studs, at 2" centers
- Upgrade to Truck-Lite LED systems using part #5050DK or 5051DK

534D

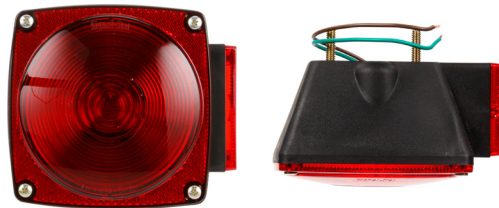

535D

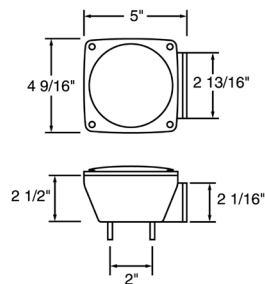

Part Number	Position	Mount Type	Lamp Connection	Plug Side 1	Plug Side 2	Volts	Amps Major/Minor
534D	LH	Bracket	Hardwired	Hardwired	Stripped End	12	2.1/0.59
535D	RH	Bracket	Hardwired	Hardwired	Stripped End	12	2.1/0.59

LED

SIGNAL-STAT

INCANDESCENT

SQUARE

INCANDESCENT

SQUARE

INCANDESCENT, STOP/TURN/TAIL KIT M/C INCLUDED, RECTANGULAR

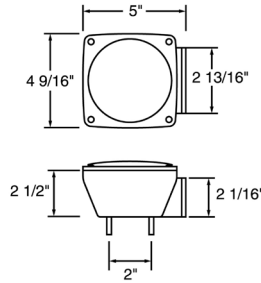

FEATURES

- For use on camping, motorcycle, horse and utility trailers
- Kit provides all legal lamps and reflective products for trailers LESS than 80" wide
- Special electrical connections eliminate external wiring splices
- Front side marker lamps include built-in reflectors
- Rugged plastic design prevents corrosion
- Kit includes two lamps, 20' four-wire split Y-harness, a flexible license bracket, two S/T/T lamps, two side marker lamps, frame clips, wire nuts and easy to read instructions
- S/T/T lamps mount on two studs at 2" centers
- Upgrade to Truck-Lite LED systems using part #5050DK or 5051DK

Functions Include

Left Hand A/I6/S2/T/ L,
Right Hand S/T/T,
Left Hand M/C Ref P2, A ,
Right Hand M/C Ref P2/A

Part Number	Position	Mount Type	Lamp Connection	Plug Side 1	Plug Side 2	Volts	Amps Major/Minor	Replacement Parts
533DK	RH/LH	Bracket	Hardwired	Hardwired	Stripped End	12	2.1/0.59	1570 light, 1570A light



INCANDESCENT

RECTANGULAR

INCANDESCENT, SUBMERSIVE, STOP/TAIL/TURN, KIT



FEATURES

- Deluxe kit features a sealed lamp capsule that protects the bulb and electrical contacts from damage by water and corrosion
- Left hand lamp includes license plate illuminator
- S/T/T lamp 8L x 2-7/8H x 2-3/4D



Functions Include

Left SAE A, I, P2, S, T
Right SAE A, I, P2, S, T, L
Left Hand M/C Ref P2/A,
Right Hand M/C Ref P2/A

Part Number	Position	Mount Type	Lamp Connection	Plug Side 1	Plug Side 2	Volts	Amps Major/Minor	Replacement Parts
530DK	RH/LH	Bracket	Hardwired	Hardwired	Stripped End/ Ring Terminal	12	2.1/0.59	528 LH light, 529 RH light, 9676 red lens



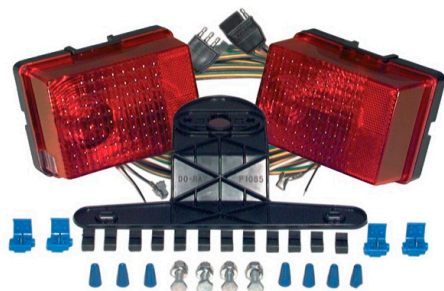

INCANDESCENT, SUBMERSIVE STOP/TAIL/TURN KIT,



FEATURES

- Popular on boat trailers under 80" wide
- Kit provides all legal lamps and reflective products for trailers LESS than 80" wide

Functions Include

Left Hand S/T/T, Right Hand S/T/T

Part Number	Position	Mount Type	Lamp Connection	Plug Side 1	Plug Side 2	Volts	Amps Major/Minor	Replacement Parts
55554	RH/LH	Bracket	Hardwired	Stripped End	Stripped End	12	2.1/0.59	80317R M/F light, 80318R M/F light w/ license, 80722 license bracket, 93960 harness
55554-1 (display)	RH/LH	Bracket	Hardwired	Stripped End	Stripped End	12	2.1/0.59	80317R M/F light, 80318R M/F light w/ license, 80722 license bracket, 93960 harness

KIT

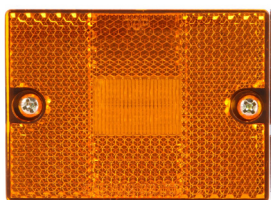

LED, 1 STUD MOUNT, MARKER/CLEARANCE LAMP 2" X 3", RECTANGULAR



Part Number	Lens Color	Lamp Connector	Plug Side 1	Plug Side 2	Volts	Amps	Diodes	Material	Lighting Codes
5052AD	Yellow	Hardwired	Hardwired	Ring Terminal/ Stripped End	12	0.05	6	AC	P2 PC

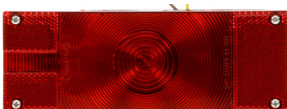

INCANDESCENT, 2 STUD MOUNT, SINGLE STOP/TURN/TAIL LAMP RECTANGULAR



FEATURES

- Main lens replaceable, bulb #9676

Part Number	Position	Mount Type	Lamp Connection	Plug Side 1	Plug Side 2	Volts	Amps Major/Minor
528	LH	Bracket	Hardwired	Hardwired	Stripped End/ Ring Terminal	12	2.1/0.59
529	RH	Bracket	Hardwired	Hardwired	Stripped End/ Ring Terminal	12	2.1/0.59

LICENSE & BACK-UP LIGHTS

LICENSE LIGHTS

Pages 172-178

Shape	Common Size	Page
ROUND		172-173
	0.75"	172
	1"	172
	2"	173
RECTANGULAR		174-178
	1 x 2"	174-176
	2 x 3"	176-177
	2 x 6"	177-178
TRIANGLE		178
	1 x 3"	178

BACK-UP LIGHTS

Pages 179-190

Shape	Common Size	Page
ROUND		179-186
	4"	179-186
RECTANGULAR		187
	3 x 5"	187
	4 x 6"	187
OVAL		188-190
	2 x 6"	188-190





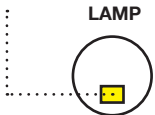
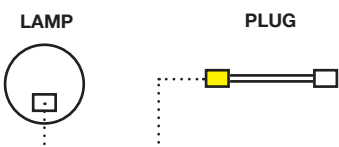
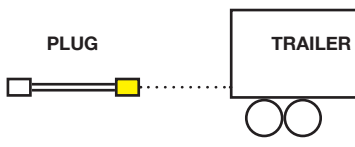

License & Back-Up Lights

Introduced originally by Truck-Lite, these bright, dependable LED back-up and license lighting and space-saving combination lamps come in a variety of shapes and sizes.

<p>Shapes</p>	<p>Round, Oval, Rectangular</p>
<p>Mount Types</p>	<p>Grommet, Flange, 2 Screw, 4 Screw, Adhesive</p>
<p>Connection Information</p> <p>When it comes to choosing the correct lamps for your truck or trailer, it's important to know the connection type on your vehicle's harness. If the harness connector type does not match your desired light (lamp connector), you will need a plug to complete the connection.</p>	<p>Lamp Connector</p> <p>The connector type located on the back of a lamp</p>  <p>Plug Side 1</p> <p>The connection between a plug and a lamp</p>  <p>Plug Side 2</p> <p>The connection between a plug and a trailer's harness</p> 

(800) 562-5012 | truck-lite.com

 <p>Manufacturing & Quality</p>	 <p>Testing & Safety</p>
<p>Truck-Lite’s LED license and back-up lighting is built using premium materials and backed by industry-leading warranties.</p> <p>Designed to last the life of your vehicle, Truck-Lite’s solid-state construction and sealed circuitry mean that you can depend on your lighting to withstand shock, vibration, moisture and debris.</p>	<p>All Truck-Lite lamps are subjected to rigorous environmental, electrical and mechanical testing before they are validated and released to the market.</p> <p>All lamps comply with FMVSS/CMVSS-108, SAE and DOT standards when properly mounted.</p>
 <p>Performance & Maintenance</p>	 <p>Customer Support</p>
<ul style="list-style-type: none"> • Lower energy consumption • Impact-resistant, non-yellowing lenses and rugged housing protect against damage from even the toughest applications • Robust, cost-effective design 	<p>Customer Service</p> <p>(800) 562-5012 customerservice@truck-lite.com</p> <p>Technical Support</p> <p>(888) 562-5012 tltech@truck-lite.com</p> <p>License/BU Light Warranties</p> 
<p>(800) 562-5012 truck-lite.com</p>	

33 SERIES, HARDWIRED, GROMMET MOUNT, LED, 1 DIODE, 0.75", ROUND

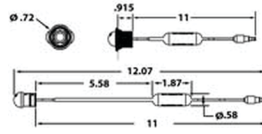

FEATURES

- Hardwired lamp design is easily retrofitted, with only a 1-3/16" mounting hole required for grommet installation
- US Patent 5,943,798
- Product designed to fit in 33705 grommet
- Top and side plate mounting options
- When mounted into a module, all wires are hidden inside module, protecting against damage from corrosion
- Does not require a bracket, so it can be mounted directly into the vehicle
- Stealth, low-profile design is resistant to damage, and hides lamp away from view to help prevent theft

Part Number	Lamp Connector	Plug Side 1	Plug Side 2	Lens Color	Lens Material	Mount Color	Volts	Amps	Kit Includes
33210C	Hardwired	Hardwired	.180 Bullet	Clear	PC	—	12	0.15	—
33010C	Hardwired	Hardwired	.180 Bullet	Clear	PC	Black	12	0.15	33210C light, 33705 grommet



26 SERIES, GROMMET MOUNT, INCANDESCENT, 1 BULB, 1" ROUND

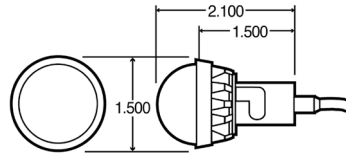

FEATURES

- Chrome-plated brass housing
- Snap-fit design uses standard 1-1/4" diameter hole
- Commonly used to illuminate a license plate on step bumpers
- Two units required for license illumination
- Ideal for courtesy, map, instrument, license or step lighting
- Snaps securely into any panel thickness up to .187"
- Uses #67 bulb

Part Number	Lamp Connector	Plug Side 1	Plug Side 2	Lens Color	Lens Material	Mount Color	Volts	Amps
26331	Hardwired	Hardwired	.180 Bullet	Clear	PC	Chrome	12	0.59

26 SERIES, 2 SCREW MOUNT, INCANDESCENT, 1 BULB, 1", ROUND

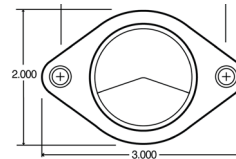

FEATURES

- Chrome-plated steel lens shade
- Design is similar to lamps used on GM vehicles
- Two lamps required for license plate illumination
- Rubberized, single-contact electrical plug
- Uses #67 bulb

Part Number	Lamp Connector	Plug Side 1	Plug Side 2	Lens Color	Lens Material	Mount Color	Volts	Amps
26336	Hardwired	Hardwired	.156 Bullet	Clear	PC	Chrome	12	0.59

LED
33 SERIES

INCANDESCENT
26 SERIES

INCANDESCENT
26 SERIES

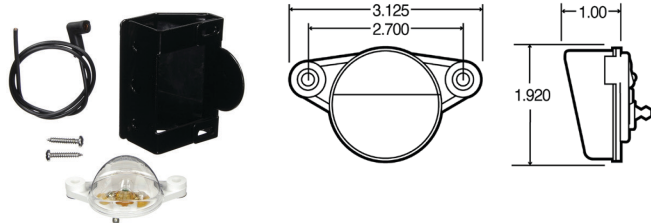

17 SERIES, BRACKET MOUNT, INCANDESCENT, 1 BULB, 2", ROUND, KIT

FEATURES

- High-impact polycarbonate, sonically sealed lens and housing
- Designed to mount with bracket, #17720
- Horizontal mount only



Part Number	Lamp Connector	Plug Side 1	Plug Side 2	Lens Color	Lens Material	Mount Color	Volts	Amps	Kit Includes
17003	License Lamp Plug	Right Angle License Lamp Plug	Blunt Cut	Clear	PC	Black	12	0.33	17200 light, 17720 bracket, 94922 plug

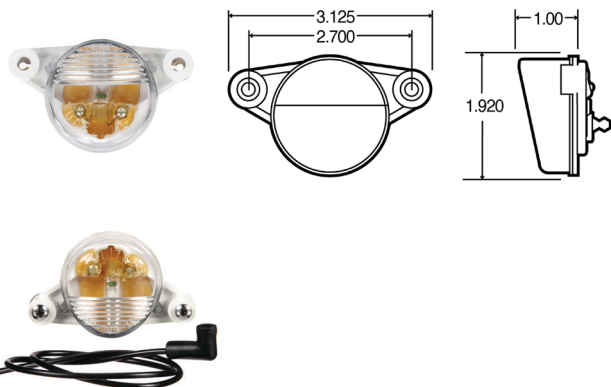

17 SERIES, 2 SCREW MOUNT, INCANDESCENT, 1 BULB, 2", ROUND

FEATURES

- High-impact polycarbonate, sonically sealed lens and housing
- Designed to mount with bracket, #17720
- Horizontal mount only



Part Number	Lamp Connector	Plug Side 1	Plug Side 2	Lens Color	Lens Material	Mount Color	Volts	Amps	Kit Includes
17200	License Lamp Plug	—	—	Clear	PC	Gray	12	0.33	—
17001	License Lamp Plug	Right Angle License Lamp Plug	Blunt Cut	Clear	PC	White	12	0.33	17200 light, 94922 plug
17002	License Lamp Plug	Straight License Lamp Plug	Blunt Cut	Clear	PC	White	12	0.33	17200 light, 94923 plug



15 SERIES, HARDWIRED, BRACKET MOUNT, LED, 3 DIODE, 1"X2", RECTANGULAR



FEATURES

- Meets SAE J587 and European ECE Regulations 4
- Hardwired design with adapter plug for quick changeover without rewiring
- Functions as utility lamp or license lamp when properly mounted using license plate brackets #00820, #15729, #15730, #15732 or #15736

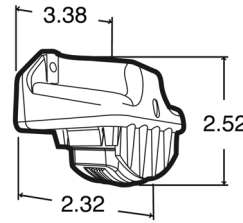
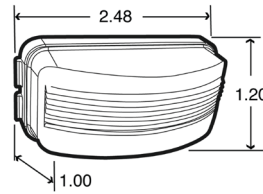

Part Number	Lamp Connector	Plug Side 1	Plug Side 2	Lens Color	Lens Material	Diamond Shell	Mount Color	Volts	Amps	Kit Includes	
15205	Hardwired	Hardwired	Female PL-10	Clear	PC	No	—	12	0.03	—	
15040	Hardwired	Hardwired	Female PL-10	Clear	PC	No	Gray	12	0.03	15205 light, 15729 Bracket Mount, 97032 gasket	(KIT)
15041	Hardwired	Hardwired	Female PL-10	Clear	PC	No	Black	12	0.03	15205 light, 15730 Bracket Mount, 97032 gasket	(KIT)
15055	Hardwired	Hardwired	Female PL-10	Clear	PC	No	Chrome	12	0.03	15205 light, 15732 Bracket Mount, 97032 gasket	(KIT)
15226	Hardwired	Hardwired	Female PL-10	Clear	AC	Yes	—	12	0.03	—	
15053	Hardwired	Hardwired	Female PL-10	Clear	AC	Yes	Gray	12	0.03	15226 light, 15729 Bracket Mount, 97032 gasket	(KIT)
15059	Hardwired	Hardwired	Female PL-10	Clear	AC	Yes	Chrome	12	0.03	15226 light, 15732 Bracket Mount, 97032 gasket	(KIT)
15061	Hardwired	Hardwired	Female PL-10	Clear	AC	Yes	Black	12	0.03	15226 light, 15730 Bracket Mount, 97032 gasket	(KIT)
15227	Hardwired	Hardwired	.180 Bullet	Clear	PC	No	—	12	0.03	—	
15054	Hardwired	Hardwired	.180 Bullet	Clear	PC	No	Gray	12	0.03	15227 light, 15729 Bracket Mount, 97032 gasket	(KIT)
15058	Hardwired	Hardwired	.180 Bullet	Clear	PC	No	Black	12	0.03	15227 light, 15730 Bracket Mount, 97032 gasket	(KIT)
15060	Hardwired	Hardwired	.180 Bullet	Clear	PC	No	Chrome	12	0.03	15227 light, 15732 Bracket Mount, 97032 gasket	(KIT)
15905	Hardwired	Hardwired	Female PL-10	Clear	PC	No	—	24	0.03	—	
15042	Hardwired	Hardwired	Stripped End	Clear	PC	No	Gray	24	0.03	15905 light, 15729 Bracket Mount, 97032 gasket	(KIT)
15043	Hardwired	Hardwired	Stripped End	Clear	PC	No	Black	24	0.03	15905 light, 15730 Bracket Mount, 97032 gasket	(KIT)
15056	Hardwired	Hardwired	Stripped End	Clear	PC	No	Chrome	24	0.03	15905 light, 15732 Bracket Mount, 97032 gasket	(KIT)

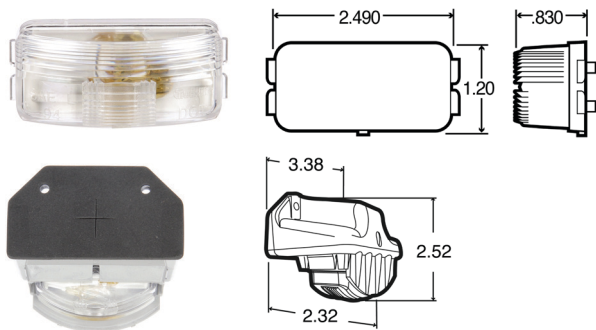

15 SERIES, BRACKET MOUNT, INCANDESCENT, 1 BULB, 1"X2", RECTANGULAR

FEATURES

- Snap-fit mount for quick installation and easy replacement



Part Number	Lamp Connector	Lens Color	Lens Material	Mount Color	Volts	Amps	Kit Includes
15208	PL-10	Clear	PC	—	12	0.33	—
15209	PL-10	Clear	PC	—	24	0.17	—
15011	PL-10	Clear	PC	Gray	12	0.33	15208 light, 15729 bracket 97032 gasket
15012	PL-10	Clear	PC	Black	12	0.33	15208 light, 15730 bracket 97032 gasket
15013	PL-10	Clear	PC	Chrome	12	0.33	15208 light, 15732 bracket, 97032 gasket



INCANDESCENT

15 SERIES

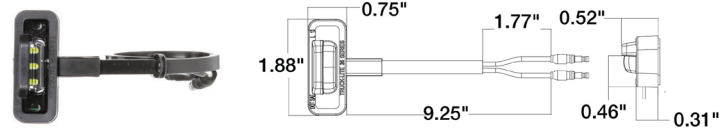

36 SERIES, HARDWIRED, ADHESIVE MOUNT, LED, 3 DIODE, 1"X2", RECTANGULAR

FEATURES

- Provides license lamp solution that requires no mounting brackets or installation screws
- Lamp adheres directly to mounting surface through use of heavy-duty adhesive backing, with an easy-to-install, peel-off liner
- OmniVolt
- Hardwired with rear and side exit wires complete with .180 molded bullets
- Can be mounted without any mounting brackets or fasteners



36145C-SIDE EXIT



36140C-REAR EXIT

Part Number	Exit	Lamp Connector	Plug Side 1	Plug Side 2	Lens Color	Lens Material	Mount Color	Volts	Amps	Kit Includes
36145C	Side	Hardwired	Hardwired	.180 Bullet	Clear	PC	Black	12 24	0.05	—
36140C	Rear	Hardwired	Hardwired	.180 Bullet	Clear	PC	Black	12 24	0.05	—
36041C	Rear	Hardwired	Hardwired	.180 Bullet	Clear	PC	Gray	12 24	0.05	36140C light, 36710 bracket
36042C	Rear	Hardwired	Hardwired	.180 Bullet	Clear	PC	Black	12 24	0.05	36140C light, 36711 bracket



LED

36 SERIES

**SIGNAL-STAT, HARDWIRED,
BRACKET MOUNT, INCANDESCENT,
1 BULB, 1"X2", RECTANGULAR**

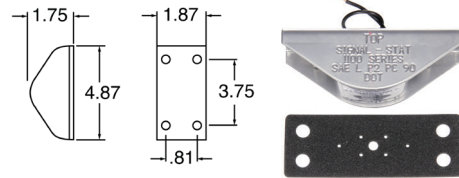

FEATURES

- Silver Powder Coat Housing
- Fully protected lens with high guard
- Pressure pad tightly seals lens
- Quick-click lens removal
- Replace bulb with #168



Part Number	Lamp Connector	Plug Side 1	Plug Side 2	Lens Color	Lens Material	Mount Color	Volts	Amps
1105W	Hardwired	Hardwired	Stripped End	Clear	PC	Gray	12	0.35

**19 SERIES, BRACKET MOUNT,
INCANDESCENT,
SEALED, 1"X2", RECTANGULAR**

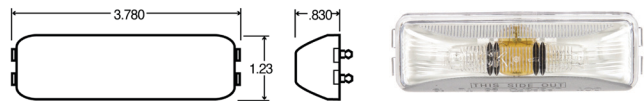

FEATURES

- High-impact polycarbonate, sonically sealed lens
- Long-life, 15,000-hour bulbs
- License or utility applications
- Keeping you legal even if one bulb fails



Part Number	Lamp Connector	Lens Color	Lens Material	Volts	Amps
19206	19 Series Male Pin	Clear	PC	12	0.33

**26 SERIES, BRACKET MOUNT,
INCANDESCENT,
1 BULB, 2"X3", RECTANGULAR**

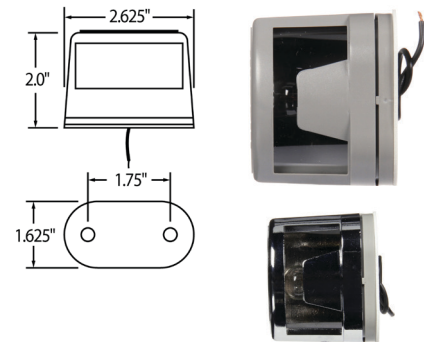

FEATURES

- High-impact housing with aerodynamic design
- Mounts on 1-3/4" hole centers
- Replace with bulb #67



Part Number	Lamp Connector	Plug Side 1	Plug Side 2	Lens Color	Lens Material	Mount Color	Volts	Amps	Kit Includes
26335	Hardwired	Hardwired	Stripped End	Clear	PC	Gray	12	0.59	26380 hood KIT
26371	Hardwired	Hardwired	Stripped End	Clear	PC	Black	12	0.59	—

INCANDESCENT

SIGNAL-STAT

INCANDESCENT

19 SERIES

INCANDESCENT

26 SERIES

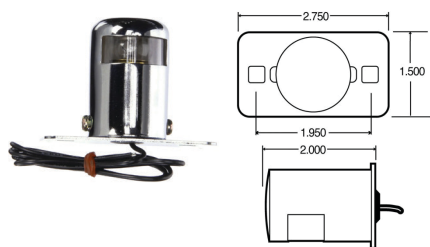

26 SERIES, HARDWIRED, 2 SCREW BRACKET MOUNT, INCANDESCENT, 1 BULB, 2"X3", RECTANGULAR

FEATURES

- Extra-rugged cadmium-plated steel housing
- Screw lock cover cams on/off for easy bulb replacement
- Ideal for license, instrument or step lighting
- Surface mounts, grounds through screw
- 1/4" screw hole diameter
- Replace with bulb #67



Part Number	Lamp Connector	Plug Side 1	Plug Side 2	Lens Color	Lens Material	Mount Color	Volts	Amps
26330	Hardwired	Hardwired	Stripped End	Clear	PC	Chrome	12	0.59

INCANDESCENT

26 SERIES



SUPER 21, 2 SCREW MOUNT, INCANDESCENT, SEALED, 2"X6", RECTANGULAR

FEATURES

- Acrylic lens and ABS housing are sonically sealed
- Unique bulb cradle shock mount absorbs shock and vibration, prolonging bulb life
- Long life bulb is rated for 15,000 hours
- Lamp kit includes #96930 hot wire



Part Number	Lamp Connector	Plug Side 1	Plug Side 2	Lens Color	Lens Material	Mount Color	Volts	Amps	Kit Includes
21204C	Super 21 Plug	—	—	Clear	AC	Clear	12	0.33	—
21004C	Super 21 Plug	Super 21 Plug	Stripped End	Clear	AC	Clear	12	0.33	21204C light, 96930 plug



INCANDESCENT

SUPER 21 SERIES

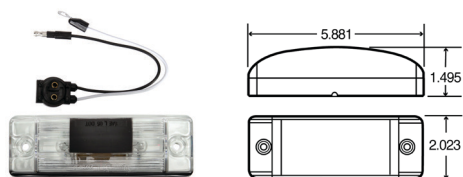

21 SERIES, 2 SCREW MOUNT, INCANDESCENT, SEALED, 2"X6", RECTANGULAR

FEATURES

- Male pin connections
- Polycarbonate lens and housing withstands impact and corrosion
- Shock mount absorbs road shock and vibration
- 2 bulb feature



Part Number	Lamp Connector	Lens Color	Plug Side 1	Plug Side 2	Lens Material	Mount Color	Volts	Amps	Kit Includes
29204C	Male Pin	Clear	—	—	PC	Clear	12	0.66	—
29004C	Male Pin	Clear	Male Pin	.180 Bullet Ring Terminal	PC	Clear	12	0.66	29204C light, 96106 plug



INCANDESCENT

21 SERIES

INCANDESCENT
SIGNAL-STAT

**SIGNAL-STAT, 2 SCREW
BRACKET MOUNT, INCANDESCENT,
1 BULB, 2"X6", RECTANGULAR**

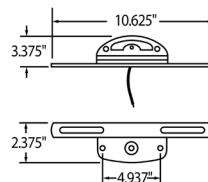

FEATURES

- Original equipment on Airstream
- Chrome-plated steel lamp body
- Rubber pad between lamp and frame
- Uses #67 bulb



Part Number	Lamp Connector	Plug Side 1	Plug Side 2	Lens Color	Lens Material	Mount Color	Volts	Amps
435W	Hardwired	Hardwired	Stripped End	Clear	AC	Chrome	12	0.59

INCANDESCENT
SIGNAL-STAT

**SIGNAL-STAT, 2 SCREW BRACKET MOUNT,
INCANDESCENT,
1 BULB, 1"X3", TRIANGULAR**

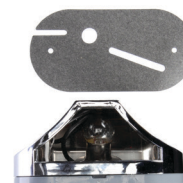
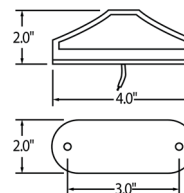

FEATURES

- Snap-grip lens hood for easy bulb replacement
- Can be used for license, instrument or step lighting
- Surface mount, grounds through screw
- Permastat housing will not rust
- Wire length 7 1/2"
- Uses #67 bulb



Part Number	Lamp Connector	Plug Side 1	Plug Side 2	Lens Color	Lens Material	Mount Color	Volts	Amps
425WD	Hardwired	Hardwired	Stripped End	Clear	PC	Gray	12	0.59
426W	Hardwired	Hardwired	Stripped End	Clear	PC	Chrome	12	0.59

SUPER 44, GROMMET MOUNT, LED, 6 DIODE, 4", ROUND



44183C - kit

FEATURES

- Surpasses back-up specifications with one-lamp, eliminating two-lamp systems
- Robust, cost-effective, efficient design
- Resembles Super 44 Series S/T/T lamp diode appearance for consistent look
- Epoxy-encapsulated with exclusive Fit 'N Forget™ plug assembly keeps corrosives away from lamp
- U.S. Registered TM #3483147



LED
SUPER 44

Part Number	Lamp Connector	Plug Side 1	Plug Side 2	Lens Color	Lens Material	Mount Color	Volts	Amps	Diamond Shell	Kit Includes
44350C	Fit 'N Forget S.S.	—	—	Clear	PC	—	12	0.53	No	—
44180C	Fit 'N Forget S.S.	Fit 'N Forget S.S.	Female PL-2	Clear	PC	Black	12	0.24	No	44350C light, 40700 grommet 94789 plug (KIT)
44183C	Fit 'N Forget S.S.	Fit 'N Forget S.S.	2 Position Plug	Clear	PC	Black	12	0.24	No	44350C light, 94212 plug, 40700 grommet (KIT)
44990C	Fit 'N Forget S.S.	—	—	Clear	AC	—	12	0.53	Yes	—
44184C	Fit 'N Forget S.S.	Fit 'N Forget S.S.	Female PL-2	Clear	AC	Black	12	0.24	Yes	44990C light, 40700 grommet, 94789 plug (KIT)
44347C	Hardwired	Hardwired	Female PL-3	Clear	PC	Black	12	0.53	No	—

SUPER 44, FLANGE MOUNT, LED, 6 DIODE, 4", ROUND



FEATURES

- Robust, cost-effective, efficient design
- Surpasses back-up specifications with 1 lamp, eliminating 2 lamp systems
- Resembles Super 44 Series S/T/T lamp diode appearance for consistent look
- Epoxy-encapsulated with exclusive Fit 'N Forget™ plug assembly keeps corrosives away from lamp
- U.S. Registered TM #3483147



Part Number	Lamp Connector	Plug Side 1	Plug Side 2	Lens Color	Lens Material	Mount Color	Volts	Amps	Diamond Shell	Kit Includes
44345C	Fit 'N Forget S.S.	—	—	Clear	PC	White	12	0.53	No	—
44348C	Hardwired	Hardwired	Stripped End	Clear	PC	Black	12	0.53	No	—
44349C	Hardwired	Hardwired	Stripped End	Clear	PC	White	12	0.53	No	—
44991C	Fit 'N Forget S.S.	—	—	Clear	AC	Gray	12	0.53	Yes	—
44992C	Fit 'N Forget S.S.	—	—	Clear	AC	Black	12	0.53	Yes	—
44344C	Fit 'N Forget S.S.	—	—	Clear	PC	Gray	12	0.53	No	—
44181C	Fit 'N Forget S.S.	Fit 'N Forget S.S.	Female PL-2	Clear	PC	Gray	12	0.24	No	44344C light, 94789 plug
44346C	Fit 'N Forget S.S.	—	—	Clear	PC	Black	12	0.53	No	—
44182C	Fit 'N Forget S.S.	Fit 'N Forget S.S.	Female PL-2	Clear	PC	Black	12	0.24	No	44346C light, 94789 plug

Ⓚ

Ⓚ



SUPER 44, GROMMET MOUNT, LED, 27 DIODE, 4", ROUND

LED
SUPER 44

FEATURES

- Most advanced and cost-effective 4" LED back-up lamps
- 27-LED pattern lamps require the purchase of two lamps, one for each side



Part Number	Lamp Connector	Plug Side 1	Plug Side 2	Lens Color	Lens Material	Mount Color	Volts	Amps	Diamond Shell	Kit Includes
44206C	Fit 'N Forget S.S.	—	—	Clear	PC	—	12	0.1	—	—
44041C	Fit 'N Forget S.S.	Fit 'N Forget S.S.	Female PL-2	Clear	PC	Black	12	0.1	No	44206C light, 40700 grommet, 94789 plug
44806C	Fit 'N Forget S.S.	—	—	Clear	AC Diamond Shell	—	12	0.1	Yes	—
44141C	Fit 'N Forget S.S.	Fit 'N Forget S.S.	Female PL-2	Clear	AC	Black	12	0.1	Yes	44806C lamp , 40700 grommet, 94789 plug

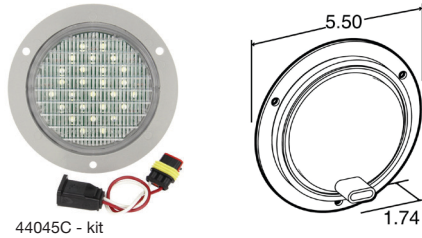

SUPER 44, FLANGE MOUNT, LED, 27 DIODE, 4", ROUND

LED
SUPER 44

FEATURES

- 27-LED pattern lamps require the purchase of two lamps, one for each side



Part Number	Lamp Connector	Plug Side 1	Plug Side 2	Lens Color	Lens Material	Mount Color	Volts	Amps	Diamond Shell	Kit Includes
44239C	Fit 'N Forget S.S.	—	—	Clear	PC	White	12	0.1	—	—
44236C	Fit 'N Forget S.S.	—	—	Clear	PC	Gray	12	0.1	—	—
44045C	Fit 'N Forget S.S.	Fit 'N Forget S.S.	Female PL-2	Clear	PC	Gray	12	0.1	No	44236C light, 94789 plug
44145C	Fit 'N Forget S.S.	—	—	Clear	AC	Gray	12	0.1	—	—
44145C	Fit 'N Forget S.S.	Fit 'N Forget S.S.	Female PL-2	Clear	AC	Gray	12	0.1	Yes	44836C light, 94789 plug
44240C	Fit 'N Forget S.S.	—	—	Clear	PC	Black	12	0.1	—	—
44146C	Fit 'N Forget S.S.	Fit 'N Forget S.S.	Female PL-2	Clear	PC	Black	12	0.1	No	44240C light, 94789 plug

LED

SUPER 44

SUPER 44, GROMMET MOUNT, LED, 54 DIODE, 4", ROUND



FEATURES

- 54-LED pattern meets requirements for use in one lamp back-up system

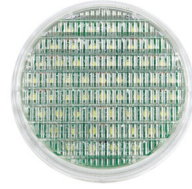

Part Number	Lamp Connector	Plug Side 1	Plug Side 2	Lens Color	Lens Material	Mount Color	Volts	Amps	Kit Includes
44205C	Fit 'N Forget S.S.	—	—	Clear	PC	—	12	0.13	—
44040C	Fit 'N Forget S.S.	Fit 'N Forget S.S.	Female PL-2	Clear	PC	Black	12	0.13	44205C light, 40700 grommet, 94789 adapter KIT

LED

SUPER 44

SUPER 44, FLANGE MOUNT, LED, 54 DIODE, 4", ROUND



FEATURES

- 54-LED pattern meets requirements for use in one lamp back-up system

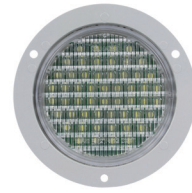
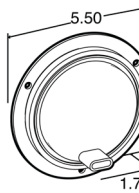

Part Number	Lamp Connector	Plug Side 1	Plug Side 2	Lens Color	Lens Material	Mount Color	Volts	Amps	Kit Includes
44235C	Fit 'N Forget S.S.	—	—	Clear	PC	Gray	12	0.13	—
44044C	Fit 'N Forget S.S.	Fit 'N Forget S.S.	Female PL-2	Clear	PC	Gray	12	0.13	44235C light, 94789 plug KIT

LED

SIGNAL STAT

SIGNAL-STAT, GROMMET MOUNT, LED, 24 DIODE, 4", ROUND



FEATURES

- Uses standard right-angle connection
- Unique LED array displays a full pattern light output design
- Two lamps required for back-up

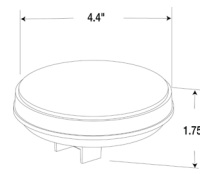

Part Number	Lamp Connector	Lens Color	Lens Material	Volts	Amps
4060C	PL-2	Clear	PC	12	0.13

SIGNAL-STAT, FLANGE MOUNT, LED, 24 DIODE, 4", ROUND



FEATURES

- Housing and flange are molded together to form one piece
- Uses standard right-angle PL-3 connection
- When properly mounted, exceeds FMVSS DOT requirements for back-up
- Unique LED array displays full pattern light output design
- Must be used as a two-lamp system for back-up



Part Number	Lamp Connector	Lens Color	Lens Material	Mount Color	Volts	Amps
4063C	PL-3	Clear	PC	Gray	12	0.15

LED

SIGNAL-STAT

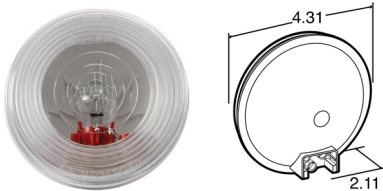

SUPER 40, GROMMET MOUNT, INCANDESCENT, SEALED, 4", ROUND

FEATURES

- Uniquely designed shock mount extends lamp life
- Sealed polycarbonate lens and housing resist heat and impact
- Not recommended for dome lamp use
- Lamp meets back-up standards on one and two lamp systems
- Flange and flush mount grommets designed for mounting in a 4-1/2" hole
- Upgrade to LED lighting systems using Truck-Lite's Super 44 Series products



Part Number	Lamp Connector	Plug Side 1	Plug Side 2	Lens Color	Lens Material	Volts	Mount Color	Amps	Kit Includes
40244	PL-2	—	—	Clear	PC	12	—	2.1	—
40044	PL-2	PL-2	Stripped End/Ring Terminal	Clear	PC	12	Black	2.1	40244 light, 40700 grommet, 94992 plug KIT

INCANDESCENT

SUPER 40

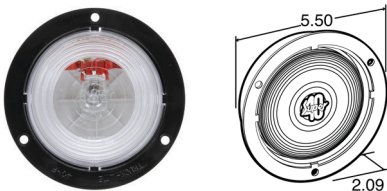

SUPER 40, FLANGE MOUNT, INCANDESCENT, SEALED, 4", ROUND

FEATURES

- Not recommended for dome lamp use
- Lamp meets back-up standards on one and two lamp systems
- Uniquely designed shock mount extends lamp life
- Sealed polycarbonate lens and housing resist heat and impact
- Flange and flush mount grommets designed for mounting in a 4-1/2" hole



Part Number	Lamp Connector	Lens Color	Lens Material	Mount Color	Volts	Amps
40260	PL-2	Clear	PC	Black	12	2.14
40261	PL-2	Clear	PC	Gray	12	2.14

INCANDESCENT

SUPER 40

INCANDESCENT

40 SERIES

40 SERIES, GROMMET MOUNT, INCANDESCENT, SEALED, 4", ROUND



FEATURE

- Not recommended for dome lamp use
- Lamp meets back-up standards on one and two lamp systems
- Polycarbonate lens and housing are sonically sealed
- Bulb is shock-mounted for extended life
- Legal only for back-up function
- Replaces Signal-Stat 4041W and 4047W
- Upgrade to LED lighting systems using Truck-Lite's Super 44 Series products

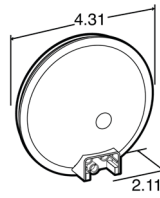

40004 - kit



40206 - Clear Back

Part Number	Lamp Connector	Plug Side 1	Plug Side 2	Lens Color	Lens Material	Mount Color	Volts	Amps	Kit Includes
40206C	PL-2	—	—	Clear	PC	12	12	2.1	—
40204	PL-2	—	—	Clear	PC	12	12	2.1	—
40004	PL-2	PL-2	Stripped End/Ring Terminal	Clear	PC	Black	12	2.1	40204 light, 40700 grommet, 94992 plug
40212	PL-2	—	—	Clear	PC	24	24	1.02	—
40012	PL-2	PL-2	Stripped End/Ring Terminal	Clear	PC	Black	24	2.1	40212 light, 40700 grommet, 94922 plug
40306	Socket Assembly	Socket Assembly	Stripped End/Ring Terminal	Clear	PC	Black	12	2.1	99010C light, 40700 grommet,

*Clear Back

KIT

KIT

KIT

INCANDESCENT

40 SERIES

40 SERIES, FLANGE MOUNT, INCANDESCENT, SEALED, 4", ROUND



FEATURES

- Polycarbonate lens and housing are sonically sealed
- Bulb is shock-mounted for extended life
- Legal only for back-up function
- Not recommended for dome lamp use
- Replaces Signal-Stat 4041W and 4047W
- Upgrade to LED Lighting Systems using Truck-Lite's Super 44 Series Products



40024 - kit



40224 - kit

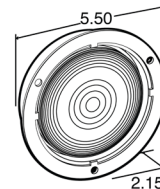

Part Number	Lamp Connector	Plug Side 1	Plug Side 2	Lens Color	Lens Material	Mount Color	Volts	Amps	Kit Includes
40224	PL-2	—	—	Clear	PC	Gray	12	2.1	—
40024	PL-2	PL-2	Stripped End/Ring Terminal	Clear	PC	Gray	12	2.1	40224 light, 94992 plug
40262	PL-2	—	—	Clear	PC	Black	12	2.1	—
40071	PL-2	PL-2	Stripped End/Ring Terminal	Clear	PC	Black	12	2.1	40262 light 94992 plug

KIT

KIT

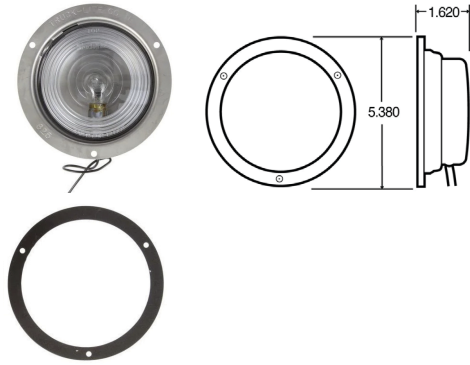

80 SERIES, HARDWIRED, FLANGE MOUNT, BULB REPLACEABLE, INCANDESCENT, 4" ROUND

FEATURES

- Flush-mount housing with recessed lens
- Snap-in retaining ring holds lens in place
- Available in three finishes - black painted steel, stainless steel or polished stainless steel
- Model 80342 requires two lamps to meet federal lighting regulations
- Uses bulb #1156



Part Number	Lamp Connector	Plug Side 1	Plug Side 2	Lens Color	Lens Material	Mount Color	Volts	Amps
80342	Hardwired	Hardwired	Blunt Cut	Clear	PC	Black	12	2.1
80344	Hardwired	Hardwired	Blunt Cut	Clear	PC	Gray	12	2.1
80345	Hardwired	Hardwired	Blunt Cut	Clear	PC	Silver	12	2.1

INCANDESCENT

80 SERIES

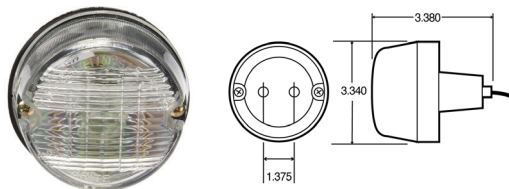

80 SERIES, HARDWIRED, 2 SCREW, INCANDESCENT

FEATURES

- Rubber body which helps absorb shock and vibration
- Can be used as back-up or utility lamp
- Requires two lamps to meet federal Lighting Regulations as a back-up lamp
- Not recommended for dome lamp use
- Uses #1156 bulb, 32 candelpower



Part Number	Lamp Connector	Plug Side 1	Plug Side 2	Lens Color	Lens Material	Mount Color	Volts	Amps	Kit Includes
80340	Hardwired	Hardwired	Blunt Cut	Clear	AC	Black	12	2.1	99095C lens KIT

INCANDESCENT

80 SERIES

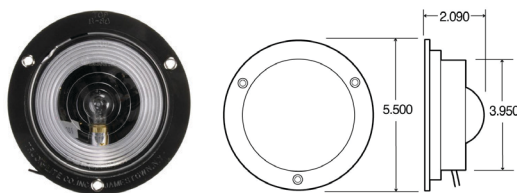

80 SERIES, HARDWIRED, FLANGE MOUNT, BULB REPLACEABLE

FEATURES

- Rubber body which helps absorb shock and vibration
- Can be used as back-up or utility lamp
- Requires two lamps to meet federal lighting regulations as a back-up lamp
- Not recommended for dome lamp use
- Uses #1156 bulb



Part Number	Lamp Connector	Plug Side 1	Plug Side 2	Lens Color	Lens Material	Mount Color	Volts	Amps	Kit Includes
80304	Hardwired	Hardwired	Stripped End	Clear	AC	Black	12	2.1	99008C lens, 97945 snap ring KIT

INCANDESCENT

80 SERIES

INCANDESCENT

SEALED INCANDESCENT, MALE PIN, 4" ROUND



FEATURES

- High-impact polycarbonate lens and housing
- Shock mount resists road shock and vibration
- Two lamps required to meet federal lighting regulations
- Not recommended for dome lamp use
- Replaces Grote #62211

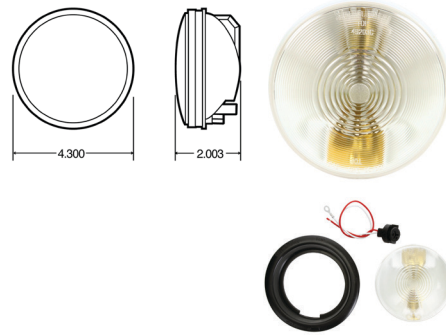

Part Number	Lamp Connector	Plug Side 1	Plug Side 2	Lens Color	Lens Material	Mount Color	Volts	Amps	Kit Includes
49203C	Male Pin	—	—	Clear	PC	—	12	2.1	—
49003C	Male Pin	Male Pin	Stripped End/Ring Terminal	Clear	PC	Black	12	2.1	49203C light, 40700 grommet, 96107plug KIT

INCANDESCENT

SIGNAL-STAT, HARDWIRED, FLANGE MOUNT, INCANDESCENT, 4" ROUND



FEATURES

- Narrow depth behind flange allows lamp to fit where other lamps cannot
- Mounts through 4-1/2" dia. cutout, 2" depth below flange
- Must use two lamps to meet back-up
- Uses #1156 bulb

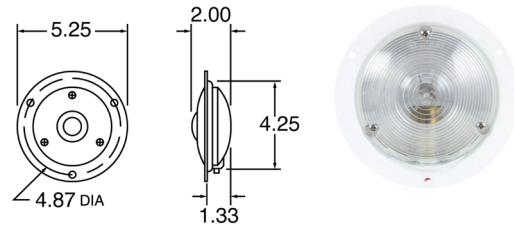

Part Number	Lamp Connector	Plug Side 1	Plug Side 2	Lens Color	Lens Material	Mount Color	Volts	Amps	Shock Mount Y/N
3613W	Hardwired	Hardwired	Stripped End	Clear	PC	Chrome	12	2.1	Y
3691W	Hardwired	Hardwired	Stripped End	Clear	PC	White	12	2.1	N
3693W	Hardwired	Hardwired	Stripped End	Clear	PC	Chrome	12	2.1	N

INCANDESCENT

SIGNAL-STAT, HARDWIRED, 4 SCREW BRACKET MOUNT, INCANDESCENT, 1 BULB, 4" ROUND



FEATURES

- Allows one light instead of two to comply with back-up lamp regulations
- Polycarbonate twist-off lens and O-ring seal
- Black plate housing: heavy gauge anodized aluminum with staked tubular bulb socket and waterproof grommet on exit wire

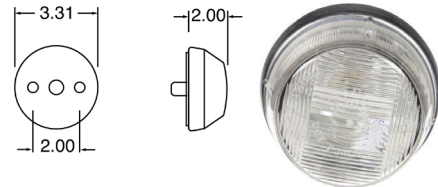

Part Number	Lamp Connector	Plug Side 1	Plug Side 2	Lens Color	Lens Material	Mount Color	Volts	Amps
92WD	Hardwired	Hardwired	Stripped End	Clear	PC	Silver	12	2.1



SIGNAL-STAT, GROMMET MOUNT, LED, 24 DIODE, 3"X5", RECTANGULAR

FEATURES

- 2 lamps required to meet back-up



Part Number	Lamp Connector	Lens Color	Lens Material	Volts	Amps
4560C	PL-2	Clear	PC	12	0.1

LED
SIGNAL-STAT

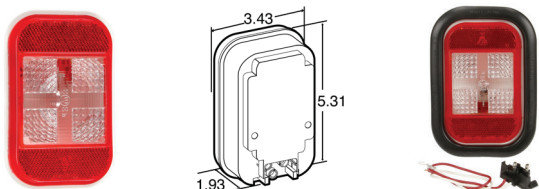

45 SERIES, SEALED BACK-UP WITH REFLECTOR, INCANDESCENT, 3"X5", RECTANGULAR

FEATURES

- Mount horizontally or vertically
- Heavy-duty, dual filament cartridge bulb
- Unique shock mount absorbs shock and vibration



Part Number	Lamp Connector	Plug Side 1	Plug Side 2	Lens Color	Lens Material	Mount Color	Volts	Amps	Kit Includes
45204	PL-2	—	—	Clear	PC	—	12	2.1	—
45004	PL-2	Right Angle PL-2	Stripped End/Ring Terminal	Clear	PC	Black	12	2.1	45204 light, 45700 grommet, 94992 plug



INCANDESCENT

SUPER 45

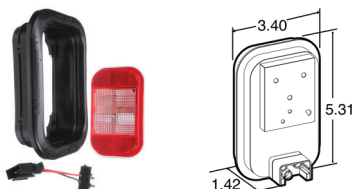

45 SERIES, SEALED BACK-UP WITH REFLECTOR, INCANDESCENT, 3"X5", RECTANGULAR

FEATURES

- Direct replacement for approved lamps on United States Postal Service L.L.V. (Long Life Vehicle)
- Designed for mounting on a 7 - 11 degree rollback from the vertical plane



Part Number	Lamp Connector	Plug Side 1	Plug Side 2	Lens Color	Lens Material	Mount Color	Volts	Amps	Kit Includes
45024	PL-2	Right Angle PL-2	Packard Connector 12020398	Clear	PC	White	12	2.1	45224 lamp, 45701 grommet, 94837 adapter



INCANDESCENT

45 SERIES

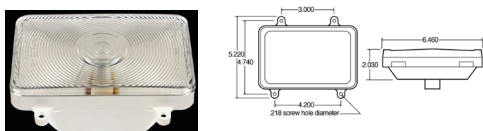

INCANDESCENT, 4 SCREW BRACKET MOUNT, 1 BULB, 4"X6", RECTANGULAR

FEATURES

- Polycarbonate lens and housing are sealed
- Bulb socket cams-in for ease of repair/replacement (sold separately)
- Recess mounts using two screws at 3.0" centers and two screws at 4.2" centers



Part Number	Lamp Connector	Lens Color	Lens Material	Mount Color	Volts	Amps
07082C	3 Blade Terminals	Clear	PC	Clear	12	2.1
07096C	Socket Assembly	Clear	PC	White	—	—

INCANDESCENT

LED
66 SERIES

**66 SERIES, GROMMET MOUNT, LED,
1 DIODE, 2"X6", OVAL**



FEATURES

- Single-diode Technology
- Uses Fit 'N Forget™ connection for increased corrosion resistance
- Two lamps required for back-up
- Meets specifications for dome lamp applications
- Must be mounted vertically
- Patent No. - USA: 6811287, Canada: 2477643, Mexico: 250259, Australia: 2003208501



Part Number	Lamp Connector	Lens Color	Lens Material	Volts	Amps
66205C	Fit 'N Forget S.S.	Clear	PC	12	0.3

LED
66 SERIES

**66 SERIES, FLANGE MOUNT, LED,
1 DIODE, 2"X6", OVAL**



FEATURES

- Single-diode Technology
- Uses Fit 'N Forget™ connection for increased corrosion resistance
- Two lamps required for back-up
- Meets specifications for dome lamp applications
- Must be mounted vertically
- Patent No. - USA: 6811287, Canada: 2477643, Mexico: 250259, Australia: 2003208501



Part Number	Lamp Connector	Lens Color	Lens Material	Mount Color	Volts	Amps
66206C	Fit 'N Forget S.S.	Clear	PC	Black	12	0.3

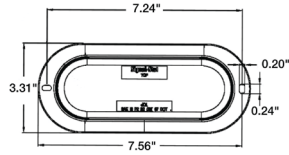

**SIGNAL-STAT,
GROMMET MOUNT, LED,
24 DIODE, 2"X6", OVAL**

FEATURES

- Uses standard right-angle connection
- 24-diode pattern
- Two lamps required for back-up
- Legal mounted horizontally or vertically



Part Number	Lamp Connector	Lens Color	Lens Material	Volts	Amps
6060C	PL-2	Clear	PC	12	0.25

LED
SIGNAL-STAT

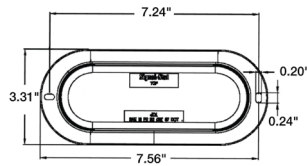

**SIGNAL-STAT,
FLANGE MOUNT, LED,
24 DIODE, 2"X6", OVAL**

FEATURES

- Housing and flange are molded together to form one piece
- Uses standard right-angle PL-2 connection
- When properly mounted, exceeds FMVSS DOT requirements for back-up
- Must be used as a two-lamp system for back-up
- 6063 can be legally mounted horizontally or vertically
- Two lamps required for back-up
- Legal mounted horizontally or vertically



Part Number	Lamp Connector	Lens Color	Lens Material	Mount Color	Volts	Amps
6063C	PL-2	Clear	PC	Gray	12	0.25

LED
SIGNAL-STAT

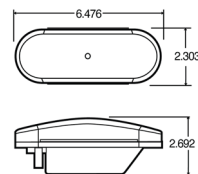

**INCANDESCENT, MALE PIN,
GROMMET MOUNT, INCANDESCENT,
2"X6", OVAL**

FEATURES

- Male pin connections
- High-impact polycarbonate lens and housing
- Shock mount resists road shock and vibration
- Two lamps required to meet federal lighting regulations
- Not recommended for dome lamp use
- Replaces Grote #62241



Part Number	Lamp Connector	Plug Side 1	Plug Side 2	Lens Color	Lens Material	Mount Color	Volts	Amps	Kit Includes
69203C	Male Pin	—	—	Clear	PC	12	2.1	—	—
69003C	Male Pin	Male Pin	Stripped End/ Ring Terminal	Clear	PC	Black	12	2.1	69203C light, 60700 grommet, 96108 plug (KIT)

INCANDESCENT
1 BULB

INCANDESCENT

60 SERIES

60 SERIES, GROMMET MOUNT, INCANDESCENT, 2"X6", OVAL



FEATURES

- High-impact polycarbonate lens and housing are sonically sealed
- Heavy-duty, shock mounted bulb
- Legal mounted vertically or horizontally
- Only one lamp required to meet federal lighting regulations
- Not recommended for dome lamp use
- Replaces Signal-Stat 4071W

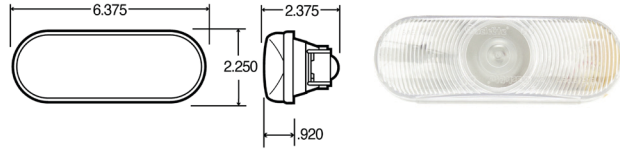

Part Number	Lamp Connector	Plug Side 1	Plug Side 2	Lens Color	Lens Material	Mount Color	Volts	Amps	Kit Includes
60204C	PL-2	—	—	Clear	PC	—	12	2.1	—
60004C	PL-2	PL-2	Stripped End/Ring Terminal	Clear	PC	Black	12	2.1	60204C light, 60700 grommet, 94922 plug KIT

INCANDESCENT

60 SERIES

60 SERIES, GROMMET MOUNT, INCANDESCENT, 2"X6", OVAL



FEATURES

- Sonically sealed lens and housing
- Socket assembly cams out for ease of bulb installation
- Two lamps required to meet federal lighting regulations
- Not recommended for dome lamp use
- Upgrade to LED Lighting Systems using Truck-Lite's 66 Series products

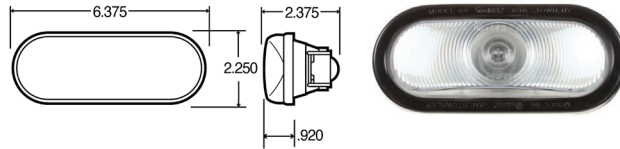

Part Number	Lamp Connector	Plug Side 1	Plug Side 2	Lens Color	Lens Material	Mount Color	Volts	Amps	Kit Includes
60345C	Socket Assembly	Socket Assembly	Stripped End/Ring Terminal	Clear	PC	Black	12	2.1	99184C light, 60700 grommet, 95415 plug KIT

INCANDESCENT

60 ECONOMY

60 ECONOMY, GROMMET MOUNT, INCANDESCENT, 2"X6", OVAL



FEATURES

- Vibration welded lens and housing
- Shock-mounted bulb to extend life
- Legal mounted horizontally or vertically
- Only one lamp required to meet federal lighting regulations
- Not recommended for dome lamp use

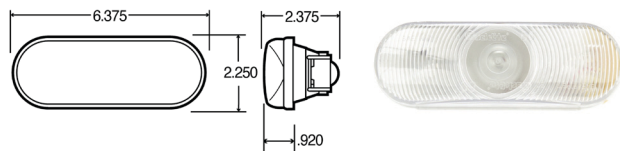

Part Number	Lamp Connector	Plug Side 1	Plug Side 2	Lens Color	Lens Material	Mount Color	Volts	Amps	Kit Includes
60284C	PL-2	—	—	Clear	PC	—	12	2.1	—
60092C	PL-2	PL-2	Stripped End/Ring Terminal	Clear	PC	Black	12	2.1	60284C light, 60700 grommet, 94992 plug KIT



KEEP YOUR CONNECTION SAFE.

Truck-Lite's multi-purpose maintenance spray – it's safe to use on or around electronics, plastics, rubber and silicone.

You can find our maintenance spray on page 450

Don't Forget Your Dielectric Gel.

Dielectric gel protects your lights by protecting the points of contact between elements of your lighting and harness system. Our dielectric compounds prevent arcing and corrosion and keep your lights performing as they should.

You can find our dielectric products on page 450



WORK LIGHTS

Technology	Type	Page
LED		196-206
	81 Series, High-Output	196
	High-Output	197-198
	81 Series	199-201
	44 Series	202
	60 Series	202
	Rigid Industries	203
	Signal-Stat	204-206
INCANDESCENT		207-208
	5 in Round	207-208
HALOGEN		209-211
	4 x 6" Rectangular	209-211









Work Lights

Put brighter, truer light right where you need it with Truck-Lite's LED work lamps. With beam patterns ranging from direct to diffused, these auxiliary lamps get the job done in any situation.

<p>Shapes</p>	<p>Round, Oval, Rectangular, Square</p>	
<p>Mount Types</p>	<p>Stud, Bracket-mount</p>	
<p>Beam Patterns</p>	<p>Work Broad and balanced area lighting</p>	
	<p>Spot Focused and far-reaching</p>	
	<p>Flood The perfect mix of distance and spread</p>	

(800) 562-5012 | truck-lite.com

 <p>Manufacturing & Quality</p>	 <p>Testing & Safety</p>
<p>Truck-Lite's LED auxiliary lighting is built using premium materials and backed by industry-leading warranties.</p> <p>Designed to last the life of your vehicle, Truck-Lite's solid-state construction and sealed circuitry mean that you can depend on your lights to withstand shock, vibration, moisture and debris.</p>	<p>All Truck-Lite auxiliary lamps are subjected to rigorous environmental, electrical and mechanical testing before they are validated and released to the market.</p> <p>To understand IP ratings go to page 5...</p>
 <p>Performance & Maintenance</p>	 <p>Customer Support</p>
<ul style="list-style-type: none"> • True-to-life light color output • Lower energy consumption • Highly controlled beam patterns • Impact-resistant, non-yellowing lenses and rugged housing protect against damage from even the toughest applications. 	<p>Customer Service  (800) 562-5012 customerservice@truck-lite.com</p> <p>Technical Support  (888) 562-5012 tltech@truck-lite.com</p> <p>Work Light Warranties</p> 
<p>(800) 562-5012 truck-lite.com</p>	

81 SERIES, LED, HIGH-OUTPUT
4", ROUND



81100
Work



81105
Flood



81110
Spot

FEATURES

- Ideal for light utility, construction, agricultural, airport and tow trucks, state and highway departments
- **IP67 rated** (go to pg.475 for more information)
- Durable black powder coated housing
- Includes stainless steel mounting hardware
- Mounts on one 5/16"-18 stud
- LED light is whiter and brighter than comparable incandescent lamps
- LEDs have no filament, therefore are extremely resistant to shock and vibration
- LEDs have less current draw, resulting in increased battery and alternator life while allowing more power for other vehicle requirements

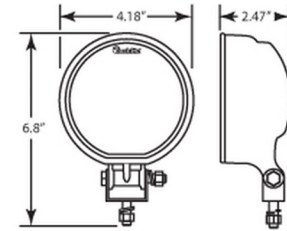

Replacement Hardware:
Part No. 97432

Part Number	Lumens	Diodes	Lamp Connection	Plug Side 1	Plug Side 2	Volts	Amps	Beam Pattern
81100	1,200	6	Hardwired	Hardwired	Stripped End	10-30	1.2	Work
81105	1,200	6	Hardwired	Hardwired	Blunt Cut	10-30	1.2	Flood
81110	1,200	6	Hardwired	Hardwired	Stripped End	10-30	1.2	Spot

WORK LIGHTS



Broad and balanced area lighting

FLOOD LIGHTS



The perfect mix of distance and spread

SPOT LIGHTS



Focused and far-reaching



**LED, HIGH-OUTPUT
MULTIPLE SIZES/BEAM PATTERNS**

FEATURES

- Multiple shapes with different beam patterns offering a perfect option for your job
- LED light, right where you need it
- Brighter, truer LED light
- Durable black powder coated housings
- Includes stainless steel mounting hardware



WORK LIGHTS

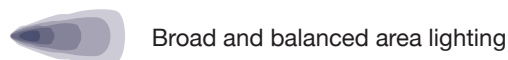

FLOOD LIGHTS

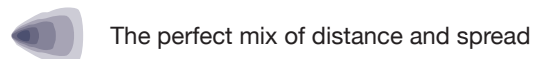

ROUND LAMPS - 4"

For IP rating information - pg.475

Part Number	Lumens	Diodes	Lamp Connection	Plug Side 1	Plug Side 2	Volts	Amps	IP Rated	Beam Pattern
8101	1600	16	Hardwired	Hardwired	Blunt Cut	10-30	1.3	IP67	Work
8104	1440	5	Hardwired	Hardwired	Blunt Cut	10-30	1.0	IP67	Flood

SQUARE LAMPS - 4"

Part Number	Lumens	Diodes	Lamp Connection	Plug Side 1	Plug Side 2	Volts	Amps	IP Rated	Beam Pattern
8103	1600	16	Hardwired	Hardwired	Blunt Cut	10-30	1.3	IP67	Work
8108	2440	6	Hardwired	Hardwired	Blunt Cut	10-30	1.7	IP68 69K	Flood

RECTANGULAR LAMPS - 2"X6"

Part Number	Lumens	Diodes	Lamp Connection	Plug Side 1	Plug Side 2	Volts	Amps	IP Rated	Beam Pattern
8102	1440	6	Hardwired	Hardwired	Blunt Cut	10-30	1.5	IP67	Work
8109	2400	6	Hardwired	Hardwired	Blunt Cut	10-30	2.5	IP67	Work

OVAL LAMPS - 4"X6"

Part Number	Lumens	Diodes	Lamp Connection	Plug Side 1	Plug Side 2	Volts	Amps	IP Rated	Beam Pattern
8105	1920	8	Hardwired	Hardwired	Blunt Cut	10-30	2.0	IP67	Flood
8107	2600	10	Hardwired	Hardwired	Blunt Cut	10-30	1.9	IP68 69K	Work

THE RIGHT LIGHT

ECONOMY LINE | 8104



RIGHT WHERE

ECONOMY LINE | 8108



YOU NEED IT.

ECONOMY LINE | 8107



**81 SERIES, LED,
4", ROUND, MULTIPLE PATTERNS**



WORK

FLOOD

SPOT



BLACK

WHITE

CHROME

FEATURES

- The first LED worklamp - 81360
- Rugged all-purpose design
- More even lighting than comparable incandescent work lamps
- LED light is whiter and brighter than comparable incandescent lamps
- LEDs have no filament, therefore are extremely resistant to shock and vibration
- 81360/81374/81365-overvoltage protection @ 17v-18v
- 81240/81270/81245-overvoltage protection @ 34v-36v
- Includes stainless steel mounting hardware
- Mounts on one 5/16"-18 stud



**Replacement Hardware:
Part No. 97432**

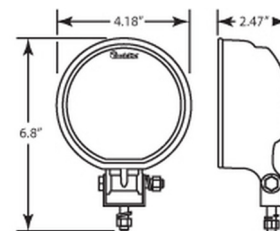

WORK LIGHTS



Broad and balanced area lighting

Part Number	Housing Color	Lumens	Diodes	Lamp Connection	Plug Side 1	Plug Side 2	Volts	Amps
81360	Black	388	6	Hardwired	Hardwired	Stripped End	12	1.2
81240	Black	500	6	Hardwired	Hardwired	Blunt Cut	24	0.5
81374	White	500	6	Hardwired	Hardwired	Blunt Cut	12	1.2
81270	White	500	6	Hardwired	Hardwired	Stripped End	24	0.5
81371	Black	500	6	Hardwired	Hardwired	Stripped End	12	1.2

FLOOD LIGHTS



The perfect mix of distance and spread

Part Number	Housing Color	Lumens	Diodes	Lamp Connection	Plug Side 1	Plug Side 2	Volts	Amps
81380	Black	388	6	Hardwired	Hardwired	Stripped End	12	1.2
81250	Black	500	6	Hardwired	Hardwired	Stripped End	24	0.5

SPOT LIGHTS



Focused and far-reaching

Part Number	Housing Color	Lumens	Diodes	Lamp Connection	Plug Side 1	Plug Side 2	Volts	Amps
81390	Black	417	6	Hardwired	Hardwired	Stripped End	12	1.2
81290	Black	500	6	Hardwired	Hardwired	Stripped End	24	0.5
81391	White	362	6	Hardwired	Hardwired	Stripped End	12	1.2
81291	White	500	6	Hardwired	Hardwired	Blunt Cut	24	0.5

81 SERIES, LED, 4", ROUND,

FEATURES 81260 (only)

- Designed to operate in extremely cold temperatures
- Includes mounting hardware and mounts on one 5/16" -18 Stud
- Rubber housing that resists corrosion

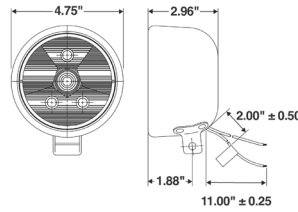

Part Number	Housing Color	Lumens	Diodes	Lamp Connection	Plug Side 1	Plug Side 2	Volts	Amps	Beam Pattern
81260	Black	250	6	Hardwired	Hardwired	Blunt Cut	12	0.53	Flood
81261	Black	250	6	Hardwired	Hardwired	Stripped End	12	0.55	Work

81 SERIES, LED, 7", ROUND, MULTIPLE PATTERNS

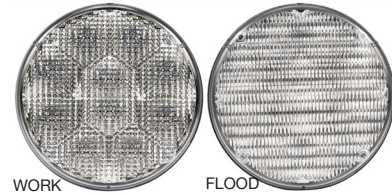
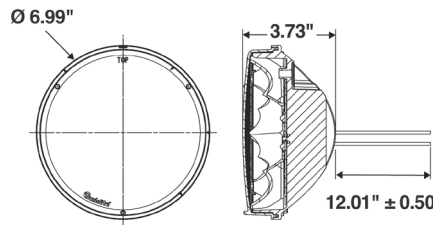

FEATURES

- Provides a robust, LED, solid-state solution to applications in need of additional lighting
- Popular for use as auxiliary lighting for off-road, utility, construction applications and more
- Offers a unique appearance, especially when installed with Truck-Lite LED headlight
- Displays a wide, uniform, symmetrical light output pattern
- Offers longer life than comparable incandescent lights
- Provides a brighter, crisper and whiter light output closer to the color temperature of daylight, dramatically improving light projection distance and overall visibility
- Metalized reflector directs light output effectively, increasing visibility
- Hardwired design and fully encapsulated electronics protect from damage caused by corrosive element
- Voltage spike protected to 600v

WORK LIGHTS Broad and balanced area lighting



Part Number	Housing Color	Lumens	Diodes	Lamp Connection	Plug Side 1	Plug Side 2	Volts	Amps	Mount Type
81702	Black	1420	10	Hardwired	Hardwired	Blunt Cut	12	4.2	Bracket (not included)
81712	Black	1420	10	Hardwired	Hardwired	Blunt Cut	12	4.2	Integral Bracket

FLOOD LIGHTS The perfect mix of distance and spread

Part Number	Housing Color	Lumens	Diodes	Lamp Connection	Plug Side 1	Plug Side 2	Volts	Amps	Mount Type
81704	Black	1500	10	Hardwired	Hardwired	Blunt Cut	12	4.2	Bracket (not included)
81714	Black	1500	10	Hardwired	Hardwired	Blunt Cut	12	4.2	Integral Bracket

SPOT LIGHTS Focused and far-reaching

Part Number	Housing Color	Lumens	Diodes	Lamp Connection	Plug Side 1	Plug Side 2	Volts	Amps	Mount Type
81701	Black	1200	10	Hardwired	Hardwired	Blunt Cut	12	4.2	Bracket (not included)
81711	Black	1200	10	Hardwired	Hardwired	Blunt Cut	12	4.2	Integral Bracket



**81 SERIES, LED,
2"X 4", RECTANGULAR, WORK LIGHT**



FEATURES

- Adds up to five feet of valuable lighting to the perimeter of your vehicle, increasing visibility in areas in which dome or back-up lighting will not reach
- Low-profile lamp protrudes only 2.5" from vehicle surface, while projecting light far beyond lamp surface
- Heavy-duty, die-cast aluminum housing with gray powder-coated surface
- Impact-resistant polycarbonate lens
- Rear fins keep heat away from LEDs and lamp circuitry
- White LEDs offer daylight-like visibility, cleaner and clearer than other light source options
- Minimal electrical draw (1.2a) allows for the use of multiple lamps, without demanding significant power from vehicle
- Hardwired .180 bullet terminals prevent pin corrosion at lamp, and install without adapters or additional wiring connections
- Ideal for use with liftgate trailers and body vehicles
- Care should be taken to install this device so that it cannot operate while the trailer or vehicle is in motion

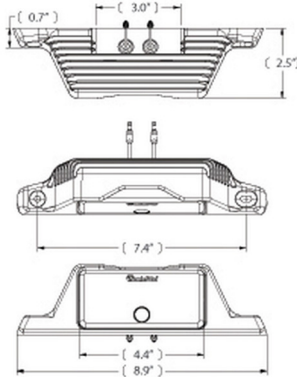

Part Number	Housing Color	Lumens	Diodes	Lamp Connection	Plug Side 1	Plug Side 2	Volts	Amps
81335C	Chrome	359	4	Hardwired	Hardwired	.180 Bullet	12	1.2



**81 SERIES, LED,
4"X 6", RECTANGULAR,
FORKLIFT WORK LIGHT**

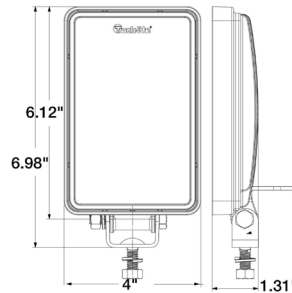

FEATURES

- UL recognized
- 12V to 48V operation
- OmniVolt design allows a single lamp to be stocked for all material handling applications, eliminating the need to carry multiple lamps with varying voltage systems
- Advanced LED technology designed for all types of material handling applications
- Vertical beam pattern is ideal for handling of large loads with obstructed views
- Elongated pattern lights up aisles and loading paths while preventing glare caused by light reflecting off carried boxes
- Pattern lights up stocking racks from floor to ceiling
- Solid-state design is ideal for use in high shock and vibration applications
- Sealed lens and potted electronics are suitable for exterior use
- Low-profile design and impact-resistant aluminum housing and polycarbonate lens prevent damage from collisions with racking systems
- Significantly lower current draw than traditional material handling lighting systems

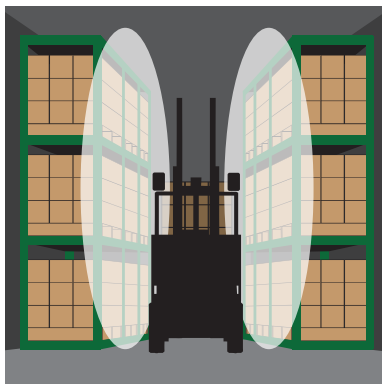

Part Number	Housing Color	Lumens	Diodes	Lamp Connection	Plug Side 1	Plug Side 2	Volts	Amps
81560	Black	766	12	Hardwired	Hardwired	Stripped End	12 24 36 48	1.24

**44[®] SERIES, LED,
4" ROUND, FLOOD LIGHT,
GROMMET MOUNT**



FEATURES

- Robust, cost-effective, efficient design
- Utilizes same six-diode pattern as traditional Truck-Lite 4" round LED lamps (STT, back-up, dome, etc.)
- Virtually impervious to shock and vibration
- Designed to operate in extremely cold temperatures

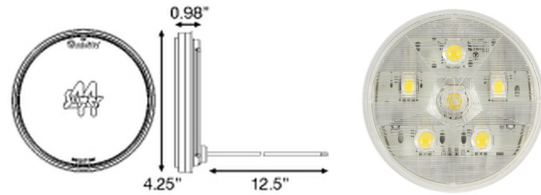

Part Number	Housing Color	Lumens	Diodes	Lamp Connection	Plug Side 1	Plug Side 2	Volts	Amps
44304C	White	250	6	Hardwired	Hardwired	Blunt Cut	12	0.53

**60[®] SERIES, LED,
2"X 6", OVAL, WORK LIGHT,
GROMMET MOUNT**



FEATURES

- Optic-free lens allows for smooth, ambient distribution of light
- Lens/housing constructed of high-grade, impact-resistant polycarbonate
- Fits into Truck-Lite 60 Series footprint, allowing for a simple retrofit of existing incandescent lamps as well as the use of existing 60 Series accessories (grommets, flanges, etc.)
- Fit 'N Forget™ connection for increased corrosion resistance
- Perfect for lighting instruments beneath vehicle

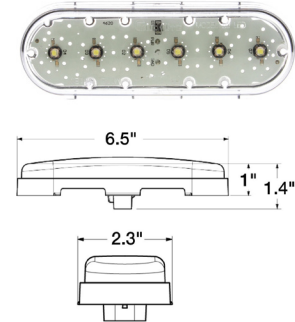

Part Number	Housing Color	Lumens	Diodes	Lamp Connection	Volts	Amps
60354C	White	450	6	Fit 'N Forget S.S.	12	0.78



**RIGID, LED,
1" X 2", RECTANGULAR, WORK LIGHT**

FEATURES

- 65 degree horizontal spread X 69 degree vertical spread
- Flat mounting surface
- Features cool white LEDs
- IP68 compliant
- Ideal for mounting when space is limited



Part Number	Housing Color	Lumens	Diodes	Lamp Connection	Plug Side 1	Plug Side 2	Volts	Amps
84715	Black	1100	3	Hardwired	Hardwired	.180 Bullet	12 24 36	0.8



**LIGHT WHERE YOU NEED IT,
WHEN YOU NEED IT.**



LED
SIGNAL-STAT

LED, 3", ROUND, WORK LIGHT



FEATURES

- Heavy-duty, die-cast aluminum housing
- Impact-resistant polycarbonate lens
- Rear fins keep heat away from LEDs and lamp circuitry
- White LEDs offer daylight-like visibility, cleaner and clearer than other light source options
- Current-regulated switching circuit
- Overvoltage protection
- SAE voltage shock protection
- EMC protection and IP 67 certified



Part Number	Housing Color	Lumens	Diodes	Lamp Connection	Plug Side 1	Plug Side 2	Volts	Amps
8140	Black	700	4	Hardwired	Hardwired	Blunt Cut	12 24 36	0.49

LED
SIGNAL-STAT

LED, 4", ROUND, WORK LIGHT



FEATURES

- Provides a brighter, crisper and whiter light output, closer to the color temperature of daylight
- OmniVolt technology allows use at 9 to 36 volts without switching
- Internal electronics completely encapsulated in epoxy, protecting against damage caused by moisture and corrosion
- Black powder-coated aluminum housing offers impact and corrosion resistance
- Offers longer life than incandescent lamps, saving time and money on replacements



Part Number	Housing Color	Lumens	Diodes	Lamp Connection	Plug Side 1	Plug Side 2	Volts	Amps
8150	Black	700	8	Hardwired	Hardwired	Stripped End	12 24 36	1.03

LED
SIGNAL-STAT

LED, 4", ROUND, FLOOD LIGHT



FEATURES

- Lamp has Harley-Davidson® auxiliary passing lamp connector
- Perfect for retrofitting inefficient incandescent Par 36 lamps to high-efficiency LED lighting
- Offers clear, white LED auxiliary illumination needed for many off-road, agricultural or general lighting needs
- Heavy-duty powder coating provides excellent protection against the elements
- Die-cast aluminum housing
- Vertical heat sink pulls heat from the housing, increasing LED lifespan
- Designed at 1.06 amps
- OmniVolt (9V-36V) design, works for 12V and 24V system



Part Number	Housing Color	Lumens	Diodes	Lamp Connection	Plug Side 1	Plug Side 2	Volts	Amps
80240	Black	736	8	Hardwired	Hardwired	Deutsch Connector	12 24 36	0.5



**LED, 4" X 6", OVAL,
FLOOD LIGHT**

FEATURES

- Heavy-duty, die-cast aluminum housing
- Lens manufactured with impact-resistant polycarbonate material
- Rear fins keep heat away from LEDs and lamp circuitry, allowing for increased light output and light longevity
- White LEDs offer daylight-like visibility, cleaner and clearer than other light source options
- Current-regulated switching circuit
- Overvoltage protection
- SAE voltage shock protection
- EMC protection and IP 67 certified



Part Number	Housing Color	Lumens	Diodes	Lamp Connection	Plug Side 1	Plug Side 2	Volts	Amps
8180	Black	1400	8	Hardwired	Hardwired	Blunt Cut	12 24 36	1

LED

SIGNAL-STAT

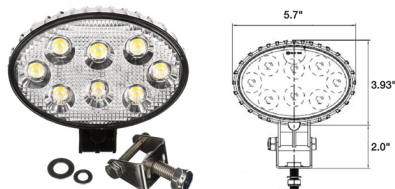

**LED, 4" X 6", OVAL,
WORK LIGHT**

FEATURES

- Heavy-duty, die-cast aluminum housing
- Lens manufactured with impact-resistant acrylic material
- Rear fins keep heat away from LEDs and lamp circuitry, allowing for increased light output and light longevity
- White LEDs offer daylight-like visibility, cleaner and clearer than other light source options
- Current-regulated switching circuit
- EMC protection



Part Number	Housing Color	Lumens	Diodes	Lamp Connection	Plug Side 1	Plug Side 2	Volts	Amps
8193	Black	1900	8	Deutsch Connector	Deutsch Connector	Stripped End	12 24	1.21

LED

SIGNAL-STAT

LED

SIGNAL-STAT

LED, 4" X 3.75", RECTANGULAR, WORK LIGHT



FEATURES

- Provides a brighter, crisper and whiter light output, closer to the color temperature of daylight, dramatically improving light projection distance and overall visibility
- Internal electronics completely encapsulated in epoxy, protecting against damage caused by moisture and corrosion
- Black powder-coated aluminum housing offers resistance to impact and corrosion
- Offers longer life than incandescent lamps, saving time and money on replacements

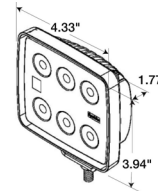

Part Number	Housing Color	Lumens	Diodes	Lamp Connection	Plug Side 1	Plug Side 2	Volts	Amps
8155	Black	638	8	Hardwired	Hardwired	Stripped End	12 24 36	1.03
8160	Black	819	10	Hardwired	Hardwired	Stripped End	12 24 36	1.08

LED

SIGNAL-STAT

LED, 3" X 3", SQUARE, WORK LIGHT



FEATURES

- Heavy-duty, die-cast aluminum housing
- Lens manufactured with impact-resistant acrylic material
- Rear fins keep heat away from LEDs and lamp circuitry, allowing for increased light output and light longevity
- White LEDs offer daylight-like visibility, cleaner and clearer than other light source options
- Current regulated switching circuit
- EMC protection
- Includes stainless steel bracket mount

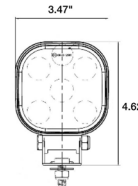

Part Number	Housing Color	Lumens	Diodes	Lamp Connection	Plug Side 1	Plug Side 2	Volts	Amps
8192	Black	1200	5	Hardwired	Hardwired	Blunt Cut	12 24	.58

LED

SIGNAL-STAT

LED, 4" X 4", SQUARE, FLOOD LIGHT



FEATURES

- Internal electronics completely encapsulated in epoxy, protecting against damage caused by moisture and corrosion
- Black powder-coated aluminum housing offers impact and corrosion resistance

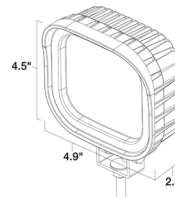

Part Number	Housing Color	Lumens	Diodes	Lamp Connection	Plug Side 1	Plug Side 2	Volts	Amps
8170	Black	846	9	Hardwired	Hardwired	Stripped End	12 24 36	1.51

INCANDESCENT, 5", ROUND, WORK LIGHT

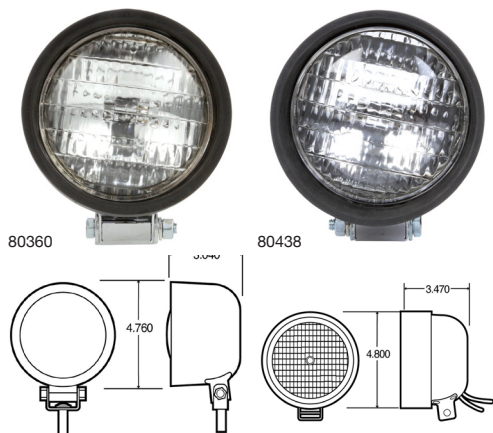

FEATURES

- Durable synthetic rubber housing resists corrosion
- Includes mounting hardware
- Contains one clear Par 36 sealed trapezoid beam with multipurpose terminals
- Fluted lens disperses light evenly
- Mounts on one 5/16"-18 stud
- Par 36 bulb, 35 watts, 2,500 candlepower
- 80360 contains: #97980-housing, #80200-bulb, #95910-mounting hardware



Part Number	Housing Color	Bulbs	Lamp Connection	Plug Side 1	Plug Side 2	Volts	Amps
80360	Black	1	Hardwired	Hardwired	Stripped End	12	2.9
80438	Black	1	Hardwired	Hardwired	Blunt Cut	12	2.9

INCANDESCENT

5 IN

INCANDESCENT, 5", ROUND, WORK LIGHT



FEATURES

- Heavy-gauge steel housing is powder-coated in black epoxy
- Includes mounting hardware
- Contains one clear Par 36 sealed trapezoid beam with multipurpose terminals
- Fluted lens disperses light evenly
- Mounts on one 5/16"-18 stud
- 35 watts, 2,500 candlepower
- Par 36
- Contains: #80200-4411 bulb, #95910-mounting hardware, #97982-housing (not available for NAPA)



Part Number	Housing Color	Bulbs	Lamp Connection	Plug Side 1	Plug Side 2	Volts	Amps
80364	Black	1	Hardwired	Hardwired	Stripped End	12	2.9

INCANDESCENT

5 IN

INCANDESCENT, 5", ROUND, WORK LIGHT



FEATURES

- Durable synthetic rubber housing resists corrosion
- Includes mounting hardware
- Contains one clear Par 36 sealed trapezoid beam with multipurpose terminals
- Fluted lens disperses light evenly
- Mounts on one 5/16" -18 stud



Part Number	Bulbs	Lamp Connection	Plug Side 1	Plug Side 2	Volts	Amps	Candlepower
80203	1	Two Screw	No Plug	No Plug	24	2.1	3500
80200	1	Two Screw	No Plug	No Plug	12	2.9	2500

INCANDESCENT

5 IN

INCANDESCENT

5 IN

INCANDESCENT, PAR 46, ROUND, INCANDESCENT, WORK LIGHT



FEATURES

- Rugged, all-purpose lamp
- Screw-on bulb connections for positive contact and easy bulb replacement
- Single wire-stud ground
- Weatherproof rubber shell for extended bulb life
- Shell remains flexible from -40°F to 125°F
- Housing available separately
- 1/2" diameter adjustable ball stud
- Contains #630H housing
- 630W uses #4419 bulb, 35 watts
- 630W4 uses 4578 bulb, 60 watts

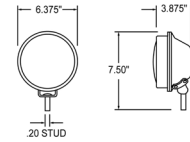

Part Number	Housing Color	Bulbs	Lamp Connection	Plug Side 1	Plug Side 2	Volts	Amps	Candlepower
630W	Black	1	Hardwired	Hardwired	Stripped End	12	3.6	1600
630W4	Black	1	Hardwired	Hardwired	Stripped End	24	2.3	1600

INCANDESCENT

5 IN

INCANDESCENT, 5", ROUND, WORK LIGHT



FEATURES

- Ideal for agricultural applications
- Functions as tractor, utility, alley or hook-up lamp for fifth wheel
- Screw-on bulb connections for positive contact and easy bulb replacement
- Single wire, stud ground
- Weatherproof rubber shell protects sealed beam for longer life
- Shell remains flexible from -40°F to 125°
- Adjustable bracket with 5/16" diameter stud
- Contains #620H housing, #95910 mounting hardware
- Par 36, 80200 beam, 35 watts

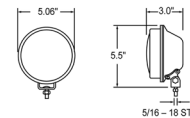

Part Number	Housing Color	Bulbs	Lamp Connection	Plug Side 1	Plug Side 2	Volts	Amps	Candlepower
62	Black	1	Hardwired	Hardwired	Blunt Cut	12	2.9	2500

INCANDESCENT

5 IN

INCANDESCENT, BULB REPLACEABLE SPOT LIGHT, 5" ROUND



FEATURES

- Durable synthetic rubber housing resists corrosion
- Includes mounting hardware
- Contains one clear Par 36 sealed trapezoid beam with multipurpose terminals
- Mounts on one 5/16"-18 stud
- Uses #95910 mounting hardware, #97980 housing



80202 - bulb only

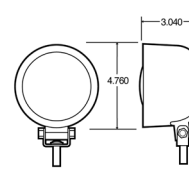

80374

Part Number	Bulbs	Lamp Connection	Volts	Amps	Watts	Candlepower
80202	1	Two Screw	12	8.3	100	110,000

HALOGEN, 4" X 6", RECTANGULAR, WORK LIGHTS



80388
Driving Beam

80394



80395
medium flood

80396
wide flood

FEATURES

- Durable synthetic rubber housing resists corrosion
- Includes mounting hardware
- Universal mount uses one 5/16"-18 stud
- Contains one glass rectangular sealed halogen beam with two right-angle terminals
- Fluted lens disperses light evenly
- 80388 – auxiliary lamp contains: #80209 bulb, 50 watts, #97989 housing, #95910 mounting hardware
- 80394 – trapezoid beam work lamp contains: #80206 bulb, 50 watts, #97989 housing, #95910 mounting hardware
- 80395 contains: #80207 medium flood beam, 50 watts, #97989 housing, #95910 hardware
- 80396 contains: #80205 wide flood bulb, 50 watt, #97989 housing, #95910 mounting hardware



Part Number	Housing Color	Bulbs	Lamp Connection	Plug Side 1	Plug Side 2	Volts	Amps	Candlepower	Beam Pattern
80388	Black	1	Hardwired	Hardwired	Stripped End	12	4.2	47000	Driving
80394	Black	1	Hardwired	Hardwired	Stripped End	12	4.2	5400	Trapezoid
80395	Black	1	Hardwired	Hardwired	Stripped End	12	4.2	5400	Medium Flood
80396	Black	1	Hardwired	Hardwired	Stripped End	12	4.2	1350	Wide Flood

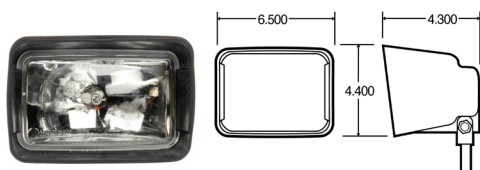

HALOGEN, 4" X 6", RECTANGULAR, SPOT LIGHT

FEATURES

- Clear lens increases output by 30-50%
- Compact 3" x 5" design
- Performs brighter and wider than larger lamps
- Bracket allows full tilt and 360° rotation adjustment
- Pre-wired with bulb
- Uses bulb #8020, 50 watt, #97989 housing, #95910 Mounitng Hardware



Part Number	Housing Color	Bulbs	Lamp Connection	Plug Side 1	Plug Side 2	Volts	Amps	Candlepower
80397	Black	1	Hardwired	Hardwired	Stripped End	12	4.2	100,000

HALOGEN, 4" X 6", RECTANGULAR, WORK LIGHT



FEATURES

- Intelligent, high-performance solution for wide variety of work lamp applications
- Two beams mean twice the lighting output of a conventional single beam unit
- For single installations, this translates to significant cost savings while producing the same output as two traditional lamps
- For true high performance, installation of 2 two-beam lamps results in phenomenal four lamp illumination
- Bracket allows full tilt and 360° rotation adjustment
- Uses two H3 bulbs #80571, 55 watt
- Polymer housing, glass lens

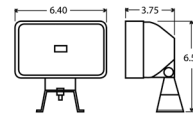

Part Number	Housing Color	Lumens	Bulbs	Lamp Connection	Plug Side 1	Plug Side 2	Volts	Amps
80498	Black	2900	2	Hardwired	Hardwired	Stripped End	12	4.5

HALOGEN, 4" X 6", RECTANGULAR



FEATURES

- Durable synthetic rubber housing resists corrosion
- Includes mounting hardware
- Universal mount uses one 5/16"-18 stud
- Contains one glass rectangular sealed halogen beam with two right-angle terminals
- Fluted lens disperses light evenly
- Uses bulb #80521 H3, 55 watt

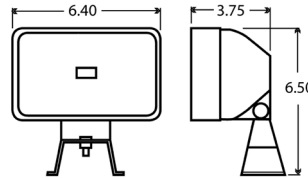

80491

Part Number	Housing Color	Lumens	Bulbs	Lamp Connection	Plug Side 1	Plug Side 2	Volts	Amps	Beam Pattern
80491	Black	2900	2	Hardwired	Hardwired	Stripped End	12	4.5	Flood
80492	Black	2900	2	Hardwired	Hardwired	Stripped End	12	4.5	Spot

HALOGEN, 4" X 6", RECTANGULAR



FEATURES

- 80204, 50 watts H9405
- 80205, 50 watts H9406
- 80206, 50 watts H9411
- 80207, 50 watts H9414
- 80209, 50 watts H9420

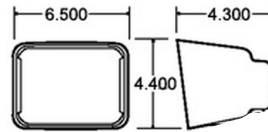

5/16 - 18 STUD



80207



80205



80209



80206

Part Number	Bulbs	Lamp Connection	Plug Side 1	Plug Side 2	Volts	Amps	Candlepower	Beam Pattern
80204	1	Two Right Angle Lugs	No Plug	No Plug	12	3.91	100,00	Spot
80205	1	Two Right Angle Lugs	No Plug	No Plug	12	4.2	1350	Wide Flood
80206	1	Two Right Angle Lugs	No Plug	No Plug	12	4.2	5400	Work
80207	1	Two Right Angle Lugs	No Plug	No Plug	12	4.2	2700	Medium Flood
80209	1	Two Right Angle Lugs	No Plug	No Plug	12	3.91	47000	Spot

HALOGEN

4 IN X 6 IN

HALOGEN

4 IN X 6 IN

HALOGEN

4 IN X 6 IN

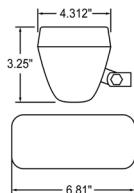

**HALOGEN, 4" X 6",
RECTANGULAR, WORK LIGHT**

FEATURES

- Direct Hobbs replacement
- Durable hard plastic housing will not weather or rust
- Advanced 55W H3 bulb technology means inexpensive bulb replacement instead of captive sealed beam replacement
- To convert these lamps to 24V - change bulb to #80561
- 1/2" adjustable hollow stud
- Contains #80571 bulb, 55 watts



Part Number	Housing Color	Lumens	Bulbs	Lamp Connection	Plug Side 1	Plug Side 2	Volts	Amps
610W	Black	1450	1	Hardwired	Hardwired	Blunt Cut	12	4.5

HALOGEN

4 IN X 6 IN

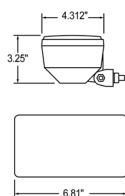

**HALOGEN, 4" X 6",
RECTANGULAR, WORK LIGHT**

FEATURES

- Rugged molded PVC housing will not break or weather - remains flexible from -40° to 120°F
- Advanced 55W H3 bulb design eliminates the need for expensive sealed beam replacement
- Precision optics
- Adjustable bracket with 5/16" stud
- Contains #80571 bulb, 55 watts



Part Number	Housing Color	Lumens	Bulbs	Lamp Connection	Plug Side 1	Plug Side 2	Volts	Amps
627WD	Black	1450	1	Hardwired	Hardwired	Stripped End	12	4.5

HALOGEN

4 IN X 6 IN

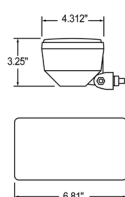

**HALOGEN, 4" X 6",
RECTANGULAR, SPOT LIGHT**

FEATURES

- Direct Hobbs replacement
- Durable hard plastic housing will not weather or rust
- Advanced 55W H3 bulb technology means inexpensive bulb replacement instead of captive sealed beam replacement
- To convert these lamps to 24V - change bulb to #80561
- 1/2" adjustable hollow stud
- Contains #80571 bulb, 55 watts



Part Number	Housing Color	Lumens	Bulbs	Lamp Connection	Plug Side 1	Plug Side 2	Volts	Amps
629WD	Black	612	1	Hardwired	Hardwired	Stripped End	12	4.5

HALOGEN

4 IN X 6 IN

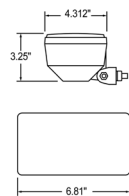
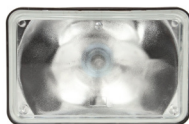

**HALOGEN, 4" X 6",
RECTANGULAR, SPOT LIGHT**

FEATURES

- Direct Hobbs replacement
- Durable hard plastic housing will not weather or rust
- Advanced 55W H3 bulb technology means inexpensive bulb replacement instead of captive sealed beam replacement - uses bulb #80571, 45 watt
- To convert these lamps to 24V - change bulb to #80561
- 1/2" adjustable hollow stud



Part Number	Housing Color	Lumens	Bulbs	Lamp Connection	Plug Side 1	Plug Side 2	Volts	Amps
628WD	Black	1450	1	Hardwired	Hardwired	Stripped End	12	4.5

HALOGEN

4 IN X 6 IN

HEADLIGHTS & FOG LIGHTS

HEADLIGHTS

Pages 218-227

Technology	Series	Page
LED		218-223
	New 7" Round	218-219
	New 5 x7"	218-219
	New 4 x 6"	218-219
	7" Round	220
	5 x7"	221
	4 x 6"	222
	ECE	223
HALOGEN		224-225
	7" Round	224
	5 x7"	225
	4 x 6"	225
CUSTOM LED		226-227
	Freightliner Cascadia, P3	227

FOG & DRIVING LIGHTS

Pages 228-233

Technology	Series	Page
LED		228-230
	4" Round	228
	44 Series	228
	45 Series	229
	Rigid Industries	230
INCANDESCENT		231
	3 x 5" Driving Light	231
HALOGEN		231-233
	3 x 5" Rectangular	231
	3 x 6" Rectangular	232
	3 x 7" Rectangular	232-233
	4 x 6"	233

SNOW PLOW LIGHTS

Pages 234-241

Technology	Series	Page
LED		234-236
	7" Round	234
	5 x 7"	235
	Snow Plow Kit Accessories	236
HALOGEN		237-241
	4 x 6"	237-241



Headlights and Fog Lights

Originally developed for the United States military, Truck-Lite's LED headlights bring combat-ready ruggedness and true-to-life color output to the civilian market in a variety of applications, whether it's heavy-duty trucks, off-road vehicles, motorcycles or classic cars.

Shapes

7" Round, 5"x7" Rectangular, 4"x6" Rectangular

Standards

DOT - Department of Transportation

The DOT functions as a governmental umbrella for anything dealing with transportation. DOT lettering is often put on lights to show that they conform to all government regulations.

NHTSA - National Highway Traffic Safety Administration

The NHTSA regulates lighting requirements for new road vehicles. Regulations take precedence over state laws and have the power to implement fines, recalls, and new regulations.

FMCSA - Federal Motor Carrier Safety Administration

The FMCSA issues Federal Motor Carrier Safety Regulations (FMCSR), which regulate vehicles over 80" wide







FMVSS-108 - Federal Motor Vehicle Safety Standard 108

The federal code that regulates lighting and performance requirements. NHTSA publishes the 108 regulations.

CMVSS-108 - Canadian Motor Vehicle Safety Standard 108

Canada's regulation code, analogous to FMVSS 108. The primary differences are that the CMVSS 108 requires daytime running lamps and allows European headlights, while FMVSS 108 does not.

(800) 562-5012 | truck-lite.com

 <p>Manufacturing & Quality</p>	 <p>Testing & Safety</p>
<p>Truck-Lite’s LED forward lighting is built using premium materials and backed by industry-leading warranties.</p> <p>Designed to last the life of your vehicle, Truck-Lite’s solid-state construction and sealed circuitry mean that you can depend on your lights to withstand shock, vibration, moisture and debris.</p>	<p>All Truck-Lite forward lighting is subjected to rigorous environmental, electrical and mechanical testing before they are validated and released to the market.</p> <p>All Truck-Lite forward lighting conforms with DOT, FMVSS-108 and CMVSS-108 requirements when properly mounted.</p>
 <p>Performance & Maintenance</p>	 <p>Customer Support</p>
<ul style="list-style-type: none"> • True-to-life light color output • Lower energy consumption • Highly controlled beam patterns • Impact-resistant, non-yellowing lenses and rugged housing protect against damage from even the toughest applications • Plug-and-play, drop-in replacements • 30x the lifespan of halogen lights 	<p>Customer Service (800) 562-5012 customerservice@truck-lite.com</p> <p>Technical Support (888) 562-5012 tltech@truck-lite.com</p> <p>Forward Lighting Warranties</p>   
<p>(800) 562-5012 truck-lite.com</p>	

TRUCK-LITE - NEVER SEEN



- NEW LOOK-

- OUTSTANDING PERFORMANCE-

SEE & BE SEEN®

- LIKE YOU'VE - SEEN BEFORE



- PROJECTOR BEAM -

- LASTING QUALITY -

More information on next page

NEW LED HEADLIGHT
7", 5"x7", 4"x6"



7" Round

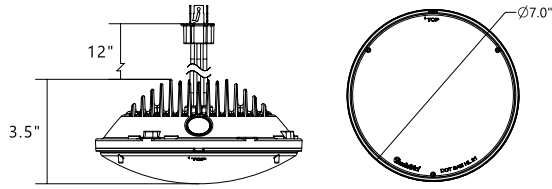

5"x7"

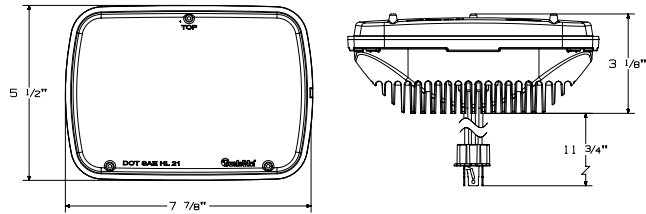

4"x6" Low Beam

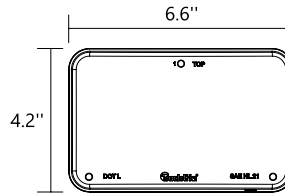

4"x6" High Beam

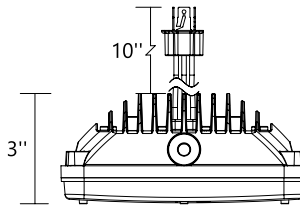

Truck-Lite's New LED Headlight Beam Pattern

**DESIGNED
TO OUTSHINE**

1. Highest light output at 600 ft. and beyond
2. Smoothest uniform beam pattern
3. Increased foreground lighting
4. Wider beam spread

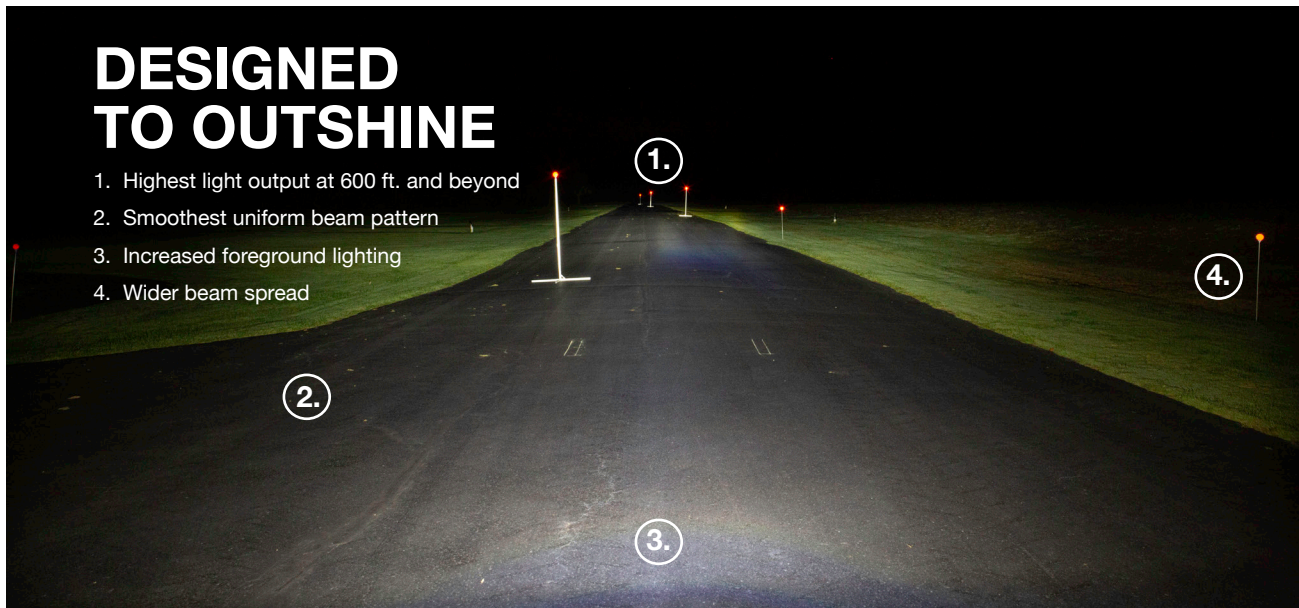

7" Round

Part Number	Lamp Connection	Plug Side 1	Plug Side 2	Volts	Current Major/Minor	Diodes	Lens Material	Housing Material	Beam Pattern
37270C	Hardwired	Hardwired	H4 Connector	12 24	2.95/1.45	2	PC	E-Coat Aluminum	High Low

5"x7"

Part Number	Lamp Connection	Plug Side 1	Plug Side 2	Volts	Current Major/Minor	Diodes	Lens Material	Housing Material	Beam Pattern
37450C	Hardwired	Hardwired	H4 Connector	12 24	2.95/1.45	2	PC	E-Coat Aluminum	High Low

4"x6" Low Beam

Part Number	Lamp Connection	Plug Side 1	Plug Side 2	Volts	Current Major/Minor	Diodes	Lens Material	Housing Material	Beam Pattern
37640C	Hardwired	Hardwired	H4 Connector	12 24	2.7/1.52	2	PC	Aluminum	Low

4"x6" High Beam

Part Number	Lamp Connection	Plug Side 1	Plug Side 2	Volts	Current Major/Minor	Diodes	Lens Material	Housing Material	Beam Pattern
37645C	Hardwired	Hardwired	H4 Connector	12 24	2.7/1.52	2	PC	Aluminum	High

FEATURES

- Eye-catching design, rugged construction and exceptional performance together in one package
- Features an integrated DRL which utilizes the low beam as a legal DRL function
- Military-grade construction
- Encapsulated electronics resist damage from corrosion and moisture
- Solid-state components are impervious to shock and vibration
- Engineered for optimum beam spread and distance
- Uniform lighting experience across driving surface
- Brighter, whiter light output than stock halogen and alternative LED options
- Designed to conform to FMVSS-108 and CMVSS-108 when properly mounted
- Excellent option for light-, medium- and heavy-duty trucks, off-road vehicles, classic cars, motorcycles and more
- Advanced circuitry protects against voltage spikes up to 600V
- Drop-in replacement for #6014, 6015, 6016, H6024 and Par 56 headlight designs
- Plug-and-play functionality: standard H4, 3-blade wiring connector

HEADLIGHT, LED, 7" COMPLEX REFLECTOR

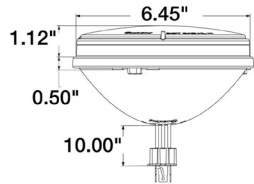

new backside housing



Heated

FEATURES

- Weight reduction by 27% (1 lb.) vs original 7 inch.
- Features an integrated DRL which utilizes the low beam as a legal DRL function
- No fins on backside of housing results in lower-profile package size and results in reduction of debris build up
- When properly mounted, the lamp is designed to conform to the requirements listed in the Department of Transportation (DOT), FMVSS-108 and Transport Canada (TC), CMVSS-108
- Metalized reflector optics provide a lighting experience that is smooth and clean across the driving surface
- Provides a brighter, crisper and whiter light output, closer to the color temperature of daylight, dramatically improving light projection distance and overall visibility
- Durability and dependability of LED lighting provides a solid-state, bulb-free headlight design that impervious to damage from shock and vibration
- Military-grade, die-cast aluminum housing and non-yellowing, polycarbonate lens offer optimum protection against damage from impact, roadside debris and other hazards
- Electronics are sealed in epoxy to resist damage caused by corrosion or moisture
- Advanced circuitry protects against voltage spikes up to 600V
- Drop-in replacement for #6014, 6015, 6016, H6024 and Par 56 headlight designs
- Uses standard H4, 3-blade wiring connector

7" Complex Reflector

Part Number	Lamp Connection	Plug Side 1	Plug Side 2	Volts	Current Major/Minor	Diodes	Lens Material	Housing Material	Beam Pattern
27270C	Hardwired	Hardwired	H4 Connector	12 24	2.95/1.45	2	PC	E-Coat Aluminum	High Low

7" Heated

- World's first heated lens LED headlight heats constantly under 10°C / 50°F
- Heated lens prevents snow, ice, and slush buildup

Part Number	Lamp Connection	Plug Side 1	Plug Side 2	Volts	Current Major/Minor	Diodes	Lens Material	Housing Material	Beam Pattern
27275C	Hardwired	Hardwired	H4 Connector	12 24	3.85/2.2	2	PC	E-Coat Aluminum	High Low

RECOMMENDED ACCESSORIES

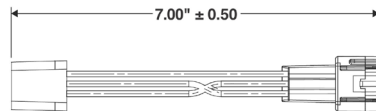

- Connects Truck-Lite's LED Headlight to a vehicle requiring a H13 connection.



96630 - H4 to H13 adapter

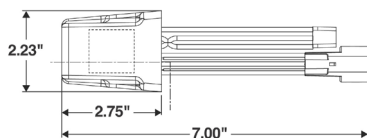

- Compatible with Jeep JK models
- The anti-flicker adaptor eliminates headlight flicker in 2007-2017 Jeeps and regular JK models utilizing PWM electrical systems
- A limited number of Jeep JK users may see a flicker as a result of the PWM electrical system used on these vehicle models
- This adapter will store power during on-time, and deliver power during off-time, allowing the lamp to receive consistent energy delivery
- Made to withstand rugged terrain
- Electronics are sealed in epoxy to resist damage caused by corrosion or moisture



96830 - PWM pigtail with H4 to H13 adapter



Heated

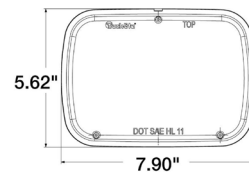
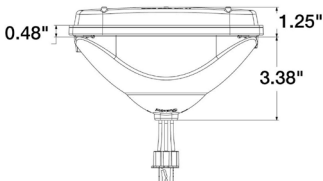

HEADLIGHT, LED, 5" X 7" COMPLEX REFLECTOR

LED
5 IN X 7 IN HEADLIGHT

FEATURES

- When properly mounted, the lamp is designed to conform to the requirements listed in the Department of Transportation (DOT), FMVSS-108 and Transport Canada (TC), CMVSS-108
- Headlights marked with the DOT symbol are street-legal
- Excellent option for light, medium and heavy-duty trucks, off-road vehicles, classic cars, motorcycles and more
- Metalized reflector optics provide a lighting experience that is smooth and clean across the driving surface
- Provides a brighter, crisper and whiter light output, closer to the color temperature of daylight, dramatically improving light projection distance and overall visibility
- Durability and dependability of LED lighting provides a solid-state, bulb-free headlight design that impervious to damage from shock and vibration
- Military-grade, die-cast aluminum housing and non-yellowing, polycarbonate lens offer optimum protection against damage from impact, roadside debris and other hazards
- Electronics are sealed in epoxy to resist from damage caused by corrosion or moisture
- Advanced circuitry protects against voltage spikes up to 600V
- Drop-in replacement for #6052, 6053, H6054, and HD6054 headlight designs
- Uses standard H4, 3-blade wiring connector

5" X 7" Complex Reflector

Part Number	Lamp Connection	Plug Side 1	Plug Side 2	Volts	Current Major/Minor	Diodes	Lens Material	Housing Material	Beam Pattern
27450C	Hardwired	Hardwired	H4 Connector	12 24	2.95/1.45	2	PC	E-Coat Aluminum	High Low

5" X 7" Heated

Part Number	Lamp Connection	Plug Side 1	Plug Side 2	Volts	Current Major/Minor	Diodes	Lens Material	Housing Material	Beam Pattern
27455C	Hardwired	Hardwired	H4 Connector	12 24	2.95/1.45	2	PC	E-Coat Aluminum	High Low

RECOMMENDED ACCESSORIES



- Connects Truck-Lite's LED Headlight to a vehicle requiring a H13 connection.

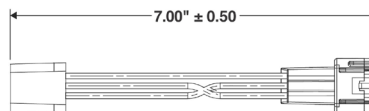

96630 - H4 to H13 adapter

HEADLIGHT, LED, 4" X 6" COMPLEX REFLECTOR



FEATURES

- Excellent option for light, medium and heavy-duty trucks, off-road and agricultural vehicles, classic cars and more
- Metalized reflector optics provide a lighting experience that's smooth and clean across the driving surface
- When properly mounted, exceeds FMVSS-108 and CMVSS-108 DOT requirements for low beam
- Provides a brighter, crisper and whiter light output that is closer to the color temperature of daylight
- Dramatically improves light projection distance and overall visibility
- Durability of LEDs provides a solid-state, bulb-free headlight design that's impervious to damage from shock and vibration
- Durable housing and non-yellowing, hard-coated polycarbonate lens offer optimum protection against damage from impact, roadside debris and other hazards
- Advanced circuitry protects against voltage spikes
- Low beam is a drop-in replacement for 2A1, 4652, H4652, H4656, H4662, H4739, and H5062 headlight designs
- Uses standard H4, 3-blade wiring connector
- Up to 50x longer life than halogen technology



LOW BEAM



HIGH BEAM

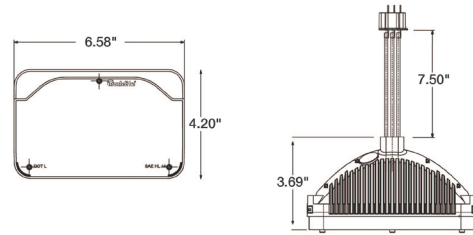

Low Beam

Part Number	Lamp Connection	Plug Side 1	Plug Side 2	Volts	Current Major/Minor	Diodes	Lens Material	Housing Material	Beam Pattern
27640C	Hardwired	Hardwired	H4 Connector	12 24	2.7/1.52	2	PC	Aluminum	Low

High Beam

Part Number	Lamp Connection	Plug Side 1	Plug Side 2	Volts	Current Major/Minor	Diodes	Lens Material	Housing Material	Beam Pattern
27645C	Hardwired	Hardwired	H4 Connector	12 24	2.7/1.52	2	PC	Aluminum	High

HEADLIGHT, LED, ECE, 7" & 5" X 7" COMPLEX REFLECTOR

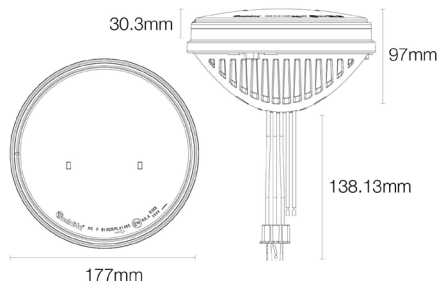

FEATURES

- ECE and ROHS compliant
- LED sealed beam technology with polycarbonate lens and sealed electronics
- Up to 50x longer life than halogen headlights, lowering lifecycle costs
- Perfect for medium/heavy-duty trucks, off-road vehicles, automotive, motorcycles, military applications and more
- Provides a brighter, crisper and whiter light output, closer to the color temperature of daylight, dramatically improving light projection distance and overall visibility
- Available in left hand traffic and right hand traffic versions
- Includes built-in position lamp with optional wiring
- Improved roadside coverage and highly controlled beam patterns, offering glare protection to oncoming traffic
- Dipped/passing beam and main/driving beam functionality
- Ultra-bright output for maximum night visibility
- H4, 3-blade connector system

7" Round

Part Number	Position	Lamp Connection	Plug Side 1	Plug Side 2	Volts	Current Major/Minor	Diodes	Lens Material	Housing Material	Beam Pattern
27290C	RH	Hardwired	Hardwired	H4 Connector/ Stripped End	12 24	2.7/1.52	2	PC	E-Coat Aluminum	High Low
27291C	LH	Hardwired	Hardwired	H4 Connector/ Stripped End	12 24	2.7/1.52	2	PC	E-Coat Aluminum	High Low

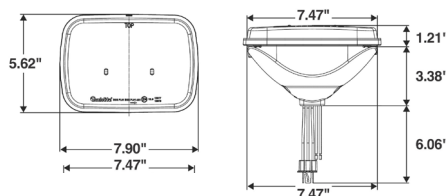

5" X 7" Rectangular

Part Number	Position	Lamp Connection	Plug Side 1	Plug Side 2	Volts	Current Major/Minor	Diodes	Lens Material	Housing Material	Beam Pattern
27490C	RH	Hardwired	Hardwired	H4 Connector/ Stripped End	12 24	2.29/1.22	2	PC	Aluminum	High Low
27491C	LH	Hardwired	Hardwired	H4 Connector/ Stripped End	12 24	2.29/1.22	2	PC	Aluminum	High Low

HALOGEN

7 IN HEADLIGHT

HEADLIGHT, HALOGEN, 7"



FEATURES

- Mechanical aim
- Polycarbonate lens provides up to 30x greater impact resistance than glass
- Easy-to-remove bulb changes out through the back of the lamp
- Bulb connector uses seal around bulb base to create weatherproof construction, preventing corrosion
- Review for appropriate bucket fit before installing

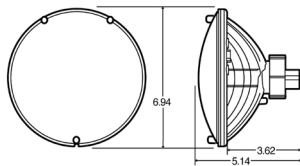

Part Number	Lamp Connection	Plug Side 1	Plug Side 2	Volts	Current Major/Minor	Diodes	Lens Material	Housing Material	Beam Pattern
27004	H4 Connector	No Plug	No Plug	12	5.1/4.3	1	PC	BMC	High Low

HALOGEN

7 IN HEADLIGHT

HEADLIGHT, HALOGEN, 7"



FEATURES

- Exceeds DOT minimum requirements by an average of 300% low beam and 225% high beam
- Mechanical aim
- Review for appropriate bucket fit for installing
- Retrofits ANSI #6014, 6015, 6016, and H6024

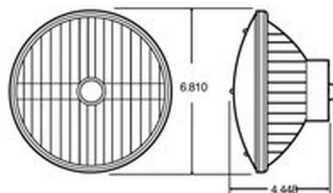

Part Number	Lamp Connection	Plug Side 1	Plug Side 2	Volts	Current Major/Minor	Diodes	Lens Material	Housing Material	Beam Pattern
27012	H4 Connector	No Plug	No Plug	12	4.69/4.3	1	Glass	Aluminum	High Low

Light with Display Packaging

Part Number	Lamp Connection	Plug Side 1	Plug Side 2	Volts	Current Major/Minor	Diodes	Lens Material	Housing Material	Beam Pattern
27012-1	H4 Connector	No Plug	No Plug	12	4.69/4.3	1	Glass	Aluminum	High Low

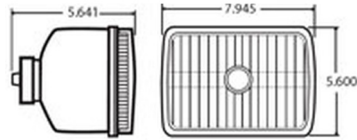

HEADLIGHT, HALOGEN, 5"X 7"

FEATURES

- Exceeds DOT minimum requirements by an average of 300% and 225% high beam
- Mechanical aim
- Review for appropriate bucket fit for installing
- Retrofits ANSI #6052, 6053, H6054, and HP6054



Part Number	Lamp Connection	Plug Side 1	Plug Side 2	Volts	Current Major/Minor	Diodes	Lens Material	Housing Material	Beam Pattern
27009	H4 Connector	No Plug	No Plug	12	4.69/4.3	1	Glass	Die-Cast Aluminum	High Low

Light with Display Packaging

Part Number	Lamp Connection	Plug Side 1	Plug Side 2	Volts	Current Major/Minor	Diodes	Lens Material	Housing Material	Beam Pattern
27009-1	H4 Connector	No Plug	No Plug	12	4.69/4.3	1	Glass	Die-Cast Aluminum	High Low

HALOGEN

5 IN X 7 IN HEADLIGHT

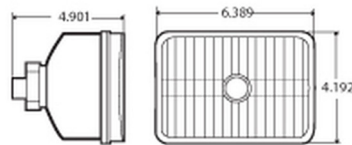

HEADLIGHT, HALOGEN, 4"X 6"

FEATURES

- Exceeds DOT minimum requirements by an average of 300% low beam and 225% high beam
- Mechanical aim
- Review for appropriate bucket fit for installing
- Retrofits ANSI #H4656
- Adapter #95846 may be needed to retrofit, included with 27011kit
- Not recommended for certain buckets on Freightliner, Kenworth or Western Star Trucks



Part Number	Lamp Connection	Plug Side 1	Plug Side 2	Volts	Current Major/Minor	Diodes	Lens Material	Housing Material	Beam Pattern
27010	H5 Connector	No Plug	No Plug	12	5.08/4.3	1	Glass	Die-Cast Aluminum	High Low
27011	H5 Connector	H5 Connector	Packard Connector 8905807	12	5.08/4.3	1	Glass	Die-Cast Aluminum	High Low



HALOGEN

4 IN X 6 IN HEADLIGHT

Custom LED Headlights

Freightliner Cascadia

Model years 2007 – 2017

From the leader in LED forward lighting, Truck-Lite's custom LED headlights are designed to greatly outperform stock halogen headlights – and cheap imitations. Our rugged construction, solid-state components and **industry-leading warranty** can help you **maximize uptime** and save on maintenance costs over the life of your vehicle. Most importantly, our pure white light output increases visibility and object recognition, helping to keep you and other drivers safer on the road.

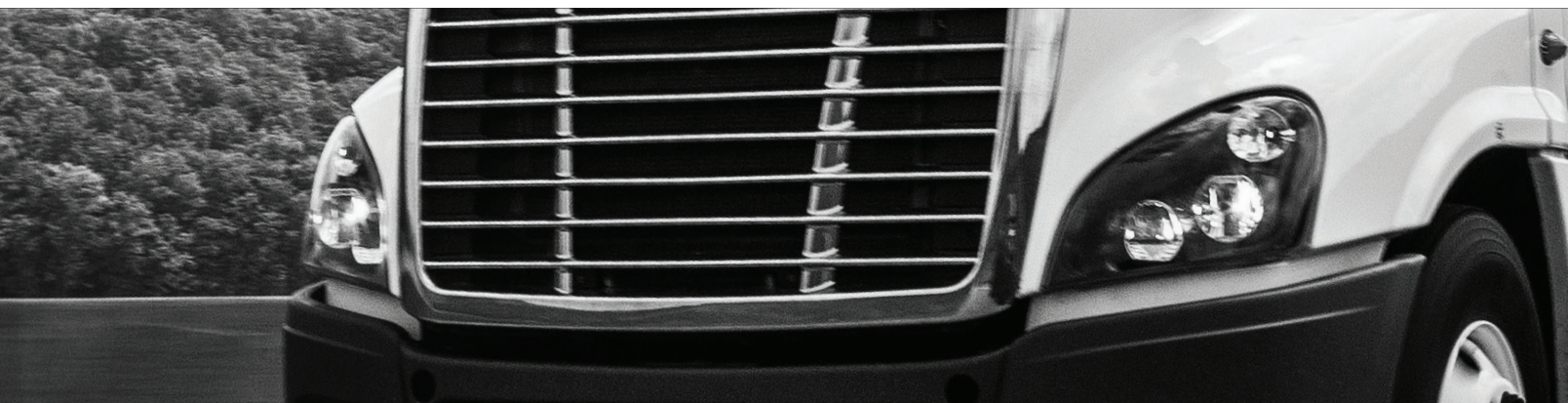

CUSTOM LED HEADLIGHT FREIGHTLINER CASCADIA, P3



FEATURES

- Model years 2007 - 2017
- Rated at over 30,000 hours
- Diamond shell 2.0 lens coating is non-yellowing and resists impact and scratches
- Quick-Aim
- Plug-and-play compatibility
- Pure white light output dramatically improves overall visibility and can help decrease driver fatigue
- DOT compliant



Part Number	Position	Lamp Connection	Plug Side 1	Plug Side 2	Volts	Current Major/Minor	Lens Material	Housing Material	Beam Pattern
27600CD	RH	8 Pin Connector	No Plug	No Plug	12	LB: 2.7-1.6 HB: 4.0-2.3 DRL: 2.34-2.12 TRN: 2.34-2.12 MRKR: .064-0.54	Hard-Coated Polycarbonate	Glass-Filled Polycarbonate	High Low
27601CD	RH	8 Pin Connector	No Plug	No Plug	12	LB: 2.7-1.6 HB: 4.0-2.3 DRL: 2.34-2.12 TRN: 2.34-2.12 MRKR: .064-0.54	Hard-Coated Polycarbonate	Glass-Filled Polycarbonate	High Low

LED

FOG LIGHT

AUXILIARY LIGHT, LED, 4", GROMMET MOUNT



Standards Met
J1306

FEATURES

- Provides a clean, streamlined look when installed along with Truck-Lite
- Pure white light output is closer to the color temperature of daylight, dramatically improving light projection distance and overall visibility with a bright, crisp output
- Complex reflector design optimizes and evenly distributed light for the best visibility pattern
- LEDs are bulb-free, and offer a solid-state design, encapsulated in hardened epoxy, to resist damage caused by shock and vibration, offering as much as 50x longer life than comparable incandescent lamps
- Solid-state LED design does not use a filament or bulb tube, and is unaffected by rigorous shock and vibration
- Die-cast aluminum housing is corrosion and impact-resistant
- Non-yellowing, impact-resistant polycarbonate lens stays clear and protects against damage from deflecting rocks and roadside debris

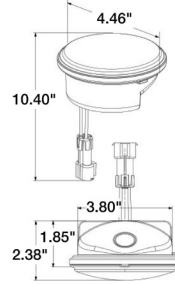

27270C LED Headlight

Part Number	Lamp Connection	Plug Side 1	Plug Side 2	Volts	Current Major/Minor	Diodes	Lens Color	Mount Material	Lens Material
80275	Hardwired	Hardwired	Packard Connector 12048159	12	0.7	1	Clear		PC

LED

44 SERIES

44 SERIES, REAR FOG LIGHT (EUROPEAN ONLY), LED, 4", GROMMET MOUNT



FEATURES

- Designed to comply with ECE Regulation 38
- Uses a .180" bullet
- Not used for a forward facing fog light

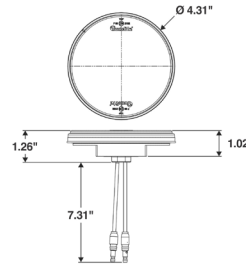

Part Number	Lamp Connection	Plug Side 1	Plug Side 2	Volts	Current Major/Minor	Diodes	Lens Color	Mount Material	Lens Material
44931R	Hardwired	Hardwired	.180 Bullet	12 24	0.71/0.13	2	Red		PC

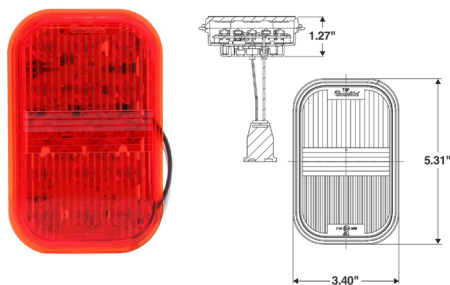

45 SERIES, REAR FOG LIGHT (EUROPEAN ONLY), LED, 3"X 5", GROMMET MOUNT

FEATURES

- Direct pin-to-circuit board solders assure vibration resistant contacts
- ECE-approved for rear position/stop direction indicator and rear fog functions
- Electronics completely sealed in epoxy to resist corrosion and moisture
- Lamps are hardwired with standard .180 molded bullet connectors
- Module receptacle wires with ring terminals available for retrofitting LED lamps to existing modules
- OmniVolt universal lighting products address increasing vehicle power demands by operating equally in electrical systems that range from 10 to 30 volts
- Sonically sealed lens and housing



Part Number	Lamp Connection	Plug Side 1	Plug Side 2	Volts	Current Major/Minor	Diodes	Lens Color	Mount Material	Lens Material
45931R	Hardwired	Hardwired	.180 Bullet	12 24	0.24	19	Red	Red	PC
45933R	Hardwired	Hardwired	PL-2	12 24	0.24	19	Red	Red	PC



45 SERIES, REAR FOG LIGHT (EUROPEAN ONLY), LED, 3"X 5", GROMMET MOUNT, KIT

FEATURES

- OmniVolt universal lighting products address increasing vehicle power demands by operating equally in electrical systems that range from 10 to 30 volts
- Lamps are hardwired with standard .180 molded bullet connectors
- Module receptacle wires with ring terminals available for retrofitting LED lamps to existing modules
- Direct pin-to-circuit board solders assure vibration resistant contacts
- Electronics completely sealed in epoxy to resist corrosion and moisture
- Low current draw, leaving more power for other vehicle requirements
- Sonically sealed lens and housing
- LEDs are less susceptible to shock and vibration
- Approved to comply with ECE regulations for Rear position/stop, direction indicator and rear fog functions



Part Number	Lamp Connection	Plug Side 1	Plug Side 2	Volts	Current Major/Minor	Diodes	Lens Color	Mount Material	Lens Material	Kit Includes
45041R	Hardwired	Hardwired	.180 Bullet	12 24	0.24	19	Red	PVC	PC	45931R light, 45700 grommet

(KIT)

**RIGID INDUSTRIES,
FOG, DRIVING, HIGHBEAM LIGHTS**
LED, BRACKET MOUNT, KIT



Standards Met
F



84720 - E-series

84764 - D-series

FEATURES

- Designed as an aftermarket fog light or auxiliary high beam kit for Universal fit
- Full XL harness with switch included
- SAE J583 compliant fog lights project high-intensity, crisp light
- Pure white light output is closer to the color temperature of daylight, dramatically improving overall visibility
- Built as a low-profile, solid-state design
- Durable die-cast housing and polycarbonate lens offer a robust package to combat damage caused by shock and vibration
- Low power draw
- Lifespan up to 50,000+ hours



84740 - SR-series

D-Series, 3"x 3" SAE Fog Light

Part Number	Lamp Connection	Plug Side 1	Plug Side 2	Volts	Current	Diodes	Lens Color	Mount Material	Lens Material
84764	Hardwired	Hardwired	Deutsch Connector	12 24 36	1.5	4	Clear	Steel	PC

(KIT)

E-Series, 6", SAE Driving Light

Part Number	Lamp Connection	Plug Side 1	Plug Side 2	Volts	Current	Diodes	Lens Color	Mount Material	Lens Material
84720	Deutsch Connector	Deutsch Connector	Ring Terminal	12 24 36	1.5	12	Clear	Steel	PC

(KIT)

SR-Series, 6", SAE Aux. Highbeam Light

Part Number	Lamp Connection	Plug Side 1	Plug Side 2	Volts	Current Major/Minor	Diodes	Lens Color	Mount Material	Lens Material
84740	Deutsch Connector	Deutsch Connector	Ring Terminal	12 24 36	2.29	6	Clear	Steel	PC

(KIT)



DRIVING LIGHT, INCANDESCENT, 3"X 5", 1 STUD MOUNT

FEATURES

- Rugged molded PVC housing will not break or weather, remaining flexible from -40°F to 120°F
- Advanced 55-watt H3 bulb design eliminates the need for expensive sealed-beam replacement
- Precision optics
- Adjustable bracket with 5/16" stud



Part Number	Lamp Connection	Plug Side 1	Plug Side 2	Volts	Current Major/Minor	Diodes	Lens Color	Mount Material	Lens Material
613W	Hardwired	Hardwired	Stripped End/ Blade Terminal	12	4.5	1	Clear	Steel	Glass

INCANDESCENT

DRIVING LIGHT

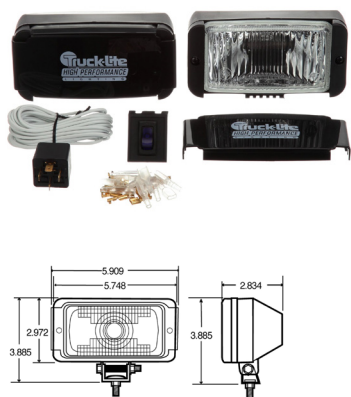

HALOGEN, 3"X 5", 1 STUD MOUNT, KIT

FEATURES

- Computer-designed optics and a vacuum-metalized steel reflector
- Simple bulb replacement through front of lamp
- Kit contains two lamps, mounting hardware, wiring kit with switch, fuse and installation instructions
- Compact design fits bumpers and spoilers for a low-profile look
- Flexible designs allows mounting above or below bumper
- Ideal for many light and recreational vehicles
- Meets or exceeds DOT/SAE and ECE standards

Standards Met
J583



Fog Light

Part Number	Lamp Connection	Plug Side 1	Plug Side 2	Volts	Current Major/Minor	Diodes	Lens Color	Mount Material	Lens Material	Kit Includes
80526	Hardwired	Hardwired	.180 Bullet	12	4.5	1	Clear	Steel	Glass	80579 light, 80603 cover, 80571 bulb, 192 relay

(KIT)

Driving Light

Part Number	Lamp Connection	Plug Side 1	Plug Side 2	Volts	Current Major/Minor	Diodes	Lens Color	Mount Material	Lens Material	Kit Includes
80525	Hardwired	Hardwired	.180 Bullet	12	4.5	1	Clear	Steel	Glass	80578 light, 80603 cover, 80571 bulb, 192 relay

(KIT)



REPLACEMENT FOG LIGHT, HALOGEN, 3"X 5"



Part Number	Lamp Connection	Plug Side 1	Plug Side 2	Volts	Current Major/Minor	Diodes	Lens Color	Lens Material
80208	Two Right Angle Lugs	No Plug	No Plug	12	4.2	1	Clear	Glass

HALOGEN

FOG LIGHT

HALOGEN

FOG LIGHT, HALOGEN, 3"X 6", 1 STUD MOUNT, KIT

Standards Met
J583



FEATURES

- Single-bolt, multi-position fastening system allows mounting from any angle and makes adjustments easier
- Simple replacement of bulb through front of lamp
- Meets or exceeds DOT/SAE and ECE standards
- One year manufacturer's warranty
- Ideal for use on heavy or medium-duty trucks and various off-highway vehicles

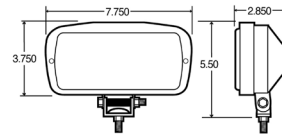

Part Number	Lamp Connection	Plug Side 1	Plug Side 2	Volts	Current Major/Minor	Diode	Lens Color	Mount Material	Lens Material	Kit Includes
80519	Hardwired	Hardwired	Stripped End/Ring Terminal	12	4.5	1	Yellow	Plastic	PC	80569 light, 80571 bulb, 80594 switch, 192 relay, 80593 wiring kit

KIT

HALOGEN

FOG LIGHT, HALOGEN, 3"X 7", 1 STUD MOUNT, KIT

Standards Met
J583



FEATURES

- Single-bolt, multi-position fastening system allows mounting from any angle and makes adjustments easier
- Simple replacement of bulb through front of lamp
- Meets or exceeds DOT/SAE and ECE standards
- One year manufacturer's warranty
- Ideal for use on heavy or medium-duty trucks and various off-highway vehicles

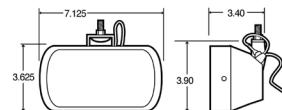

Part Number	Lamp Connection	Plug Side 1	Plug Side 2	Volts	Current Major/Minor	Diode	Lens Color	Mount Material	Lens Material	Kit Includes
80521	Hardwired	Hardwired	Stripped End/Ring Terminal	12	4.5	1	Clear	Plastic	Glass	80573 light, 80592 stone guard, 192 relay, 80571 bulb, 80593 wiring kit, 80594 switch
80514	Hardwired	Hardwired	Stripped End/Ring Terminal	12	4.5	1	Clear	Plastic	PC	80568 light, 80592 stone guard, 192 relay, 80571 bulb, 80593 wiring kit, 80594 switch
80522	Hardwired	Hardwired	Stripped End/Ring Terminal	12	4.5	1	Yellow	Plastic	Glass	80574 light, 80592 stone guard, 192 relay, 80571 bulb, 80593 wiring kit, 80594 switch

KIT

KIT

KIT

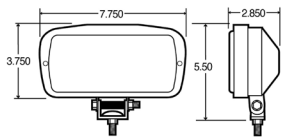

DRIVING LIGHT, HALOGEN, 3"X 7", 1 STUD MOUNT, KIT

FEATURES

- Single-bolt, multi-position fastening system allows mounting from any angle and makes adjustments easier
- Simple replacement of bulb through front of lamp
- Meets or exceeds DOT/SAE and ECE standards
- One year manufacturer's warranty
- Ideal for use on heavy or medium-duty trucks and various off-highway vehicles

Standards Met
J583



Part Number	Lamp Connection	Plug Side 1	Plug Side 2	Volts	Current Major/Minor	Diode	Lens Color	Mount Material	Lens Material	Kit Includes
80513	Hardwired	Hardwired	Stripped End/Ring Terminal	12	4.5	1	Clear	Plastic	PC	880567 light, 80592 stone guard, 192 relay, 80571 bulb, 80593 wiring kit, 80594 switch (KIT)
80520	Hardwired	Hardwired	Stripped End/Ring Terminal	12	4.5	1	Clear	Plastic	Glass	80572 light, 80592 stone guard, 192 relay, 80571 bulb, 80593 wiring kit, 80594 switch (KIT)

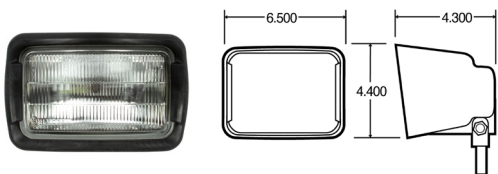

FOG LIGHT, HALOGEN, 4"X 6", 1 STUD MOUNT

FEATURES

- Durable synthetic rubber housing resists corrosion
- Includes mounting hardware
- Universal mount uses one 5/16"-18 stud
- Contains one glass rectangular sealed halogen beam with two right-angle terminals
- Fluted lens disperses light evenly



Part Number	Lamp Connection	Plug Side 1	Plug Side 2	Volts	Current Major/Minor	Diodes	Lens Color	Mount Material	Lens Material	Replacement Parts
80389	Hardwired	Hardwired	Stripped End	12	2.93	1	Clear	Steel	Glass	80208 light, 95910 hardware, 97989 housing (KIT)

SNOW PLOW LIGHT, LED, 7", 1 STUD MOUNT, KIT



FEATURES

- Provides a robust, LED, solid-state solution to plowing applications in need of durable lighting that can withstand shock and vibration, replacing headlights and turn signal lights blocked by the plow assembly
- Design draws less current, allowing more power for other vehicle requirements
- DOT-compliant LED headlight provides a brighter, crisper and whiter light output, closer to the color temperature of daylight, dramatically improving light projection distance and increasing visibility
- Advanced white LED technology reduces concerns with EMI and offers substantially longer life than comparable incandescent lights
- Complex reflector design spreads light in a clean, more uniform pattern
- Lights are hardwired, with fully encapsulated electronics to protect from damage caused by corrosive elements and moisture
- Corrosion-resistant, powder-coated aluminum housing dissipates heat efficiently
- Impact-resistant polycarbonate lenses protect against damage caused by debris and other hazards

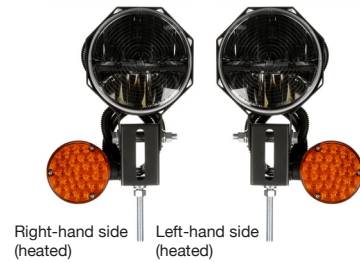
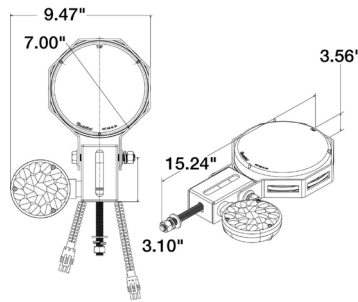

HEATED FEATURES

- World's first heated-lens LED headlight heats constantly under 10°C/50°F
- Heated lens prevents snow, ice, and slush buildup
- Utilizes Truck-Lite's 27275C seven inch round heated LED headlight

Snow Plow Kit

Part Number	Lens Color	Lens Material	Lamp Connection	Plug Side 1	Plug Side 2	Volts	Maps Major/Minor	Mount Material	Mount Color	Housing Material	
80880	Clear	PC	Hardwired	Hardwired	Packard Connector 12020829	12 24	3.6/1.8	Steel	Black	Die-Cast Aluminum	
80990	Heated Clear	PC	Hardwired	Hardwired	Packard Connector 12020829/ Packard Connector 12015793	12	3.8 / 2.1	Steel	Black	Die-Cast Aluminum	

80880 Kit Includes
80878 right light, 80879 left light, 80867 turn signal, 80898 harness

80990 Heated Kit Includes
80988 right light, 80989 left light, 80867 turn signal, 80898 harness

Right Hand Side

Part Number	Lens Color	Lens Material	Lamp Connection	Plug Side 1	Plug Side 2	Volts	Maps Major/Minor	Mount Material	Mount Color	Housing Material
80878	Clear	PC	Hardwired	Hardwired	Packard Connector 12020829	12	3.6/1.8	Steel	Black	Die-Cast Aluminum
80988	Heated Clear	PC	Hardwired	Hardwired	Packard Connector 12020829/ Packard Connector 12015793	12	3.8 / 2.1	Steel	Black	Die-Cast Aluminum

Left Hand Side

Part Number	Lens Color	Lens Material	Lamp Connection	Plug Side 1	Plug Side 2	Volts	Maps Major/Minor	Mount Material	Mount Color	Housing Material
80879	Clear	PC	Hardwired	Hardwired	Packard Connector 12020829	12	3.6/1.8	Steel	Black	Die-Cast Aluminum
80989	Heated Clear	PC	Hardwired	Hardwired	Packard Connector 12020829/ Packard Connector 12015793	12	3.8 / 2.1	Steel	Black	Die-Cast Aluminum

SNOW PLOW LIGHT, LED, 5"X 7" 1 STUD MOUNT, KIT

LED
SNOW PLOW



Snow plow kit (heated)

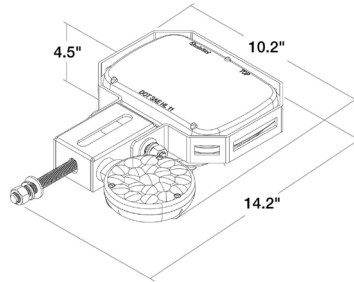

FEATURES

- Advanced white LED technology eliminates EMI and offers substantially longer life than comparable incandescent lamps
- Both lamps are hardwired with fully encapsulated electronics to protect from damage caused by corrosive

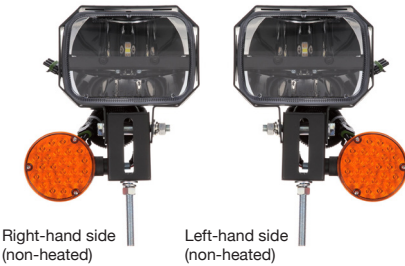

Right-hand side (non-heated)

Left-hand side (non-heated)

- elements and moisture
- Brighter and crisper light output improves light projection distance and increases visibility
- Complex reflector design spreads light in a clean, more uniform pattern
- Pedestal lamp features a unique LED diode array with a full pattern
- Provides a robust LED solid-state solution to applications in need of durable lighting that can withstand shock and vibration popular for utility/municipality use
- LED design draws less current and allows more power for other vehicle requirements

HEATED FEATURES

- Heated-lens LED headlight heats constantly under 10°C/50°F
- Heated lens prevents snow, ice, and slush buildup

Snow Plow Kit

Part Number	Lens Color	Lens Material	Lamp Connection	Plug Side 1	Plug Side 2	Volts	Maps Major/Minor	Mount Material	Mount Color	Housing Material
80875	Clear	PC	Hardwired	Hardwired	Packard Connector 12020829	12	3.6/1.8	Steel	Black	Aluminum/ Die Cast Zinc
80985	Heated Clear	PC	Hardwired	Hardwired	Packard Connector 12020829/ Packard Connector 12015793	12	3.6/1.8	Steel	Black	Aluminum/ Die Cast Zinc

80875 Kit Includes
80873 left light, 80874 right light, 80867 turn signal, 80898 harness

80985 Heated Kit Includes
80984 Right light, 80983 Left light, 80867 turn signal, 80898 harness

Left Hand Side

Part Number	Lens Color	Lens Material	Lamp Connection	Plug Side 1	Plug Side 2	Volts	Maps Major/Minor	Mount Material	Mount Color	Housing Material
80873	Clear	PC	Hardwired	Hardwired	Packard Connector 12020829	12	3.6/1.8	Steel	Black	Aluminum/ Die Cast Zinc
80983	Heated Clear	PC	Hardwired	Hardwired	Packard Connector 12020829	12	3.6/1.8	Steel	Black	Aluminum/ Die Cast Zinc

Right Hand Side

Part Number	Lens Color	Lens Material	Lamp Connection	Plug Side 1	Plug Side 2	Volts	Maps Major/Minor	Mount Material	Mount Color	Housing Material
80874	Clear	PC	Hardwired	Hardwired	Packard Connector 12020829	12	3.6/1.8	Steel	Black	Aluminum/ Die Cast Zinc
80984	Heated Clear	PC	Hardwired	Hardwired	Packard Connector 12020829	12	3.6/1.8	Steel	Black	Aluminum/ Die Cast Zinc

SNOW PLOW ADAPTER KITS

- These adapters are compatible with the Truck-Lite 80900 kit.



Part Number	Headlamp Type	Headlamp Bulb Numbers
80972	2E bulb	HP6545/H6545/4166
80974	1A/2A	4651/4652/H4651/H4652/H4662
80971	HB1	H9004
80973	2D/2B	6014/H6024/H6014/6052/H6054/HP6054
80970	HB5	H9007

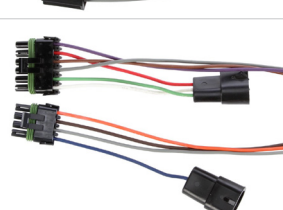
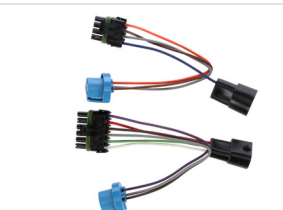
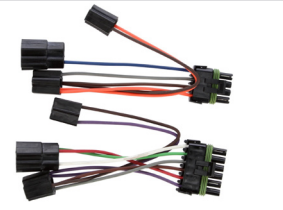

SNOW PLOW AND ATL SWITCH MOUNTING HARDWARE, KIT



- Kit includes a switch, a grommet that protects wiring at the switch, and a heavy-duty flasher



Part Number	Kit Includes
80840	1 Grommet, 7 Splice Scotch Lock, 2 Ball Mount, 1 Flasher Fuse, 2 Washer, 1 Switch, 2 Nut

SNOW PLOW AND ATL SWITCH MOUNTING HARDWARE, KIT



Part Number	Kit Includes
80844	8 Nut, 2 Ball Mount, 2 Washer, 1 Switch, 2 Male Tabs



SNOW PLOW, HALOGEN, 4"X 6", 1 STUD MOUNT, ATL-DRL, KIT

HALOGEN

SNOW PLOW



SNOW PLOW KIT



RIGHT-HAND SIDE

LEFT-HAND SIDE

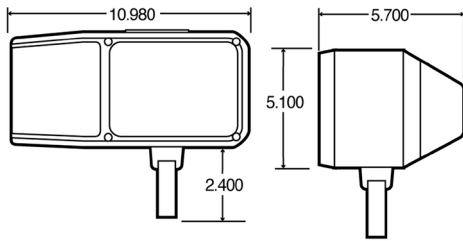

FEATURES

- High-impact polycarbonate and steel construction
- Features high/low beam halogen headlights and integrated park/turn lamps
- Adapts easily to vehicle equipped with daytime running light (DRL) systems
- Unique plug-in adapter design allows installation without cutting or splicing existing wiring
- Mounts on one 1/2" - 13 stud
- Normal DRL function transferred to snow plow lights
- Use matrix to determine appropriate adapter plug kit, sold separately
- Wiring system features weatherproof Packard connectors to prevent corrosion problems
- DRL kit includes a switch and a heavy-duty flasher
- Not compatible with vehicles using quad headlight or separate DRL headlights



Snow Plow Kit

Part Number	Lens Color	Lens Material	Lamp Connection	Plug Side 1	Plug Side 2	Volts	Maps Major/Minor	Mount Material	Mount Color	Housing Material
80900	Clear	PC	Hardwired	Hardwired	Packard Connector 12010975	12	5.08/3.52	Steel	Black	PC

KIT

80900 Kit Includes
80910 light, 80920 light, 80930 harness, 97224 switch, 80940 hardware

Left Hand Side

Part Number	Lens Color	Lens Material	Lamp Connection	Plug Side 1	Plug Side 2	Volts	Maps Major/Minor	Mount Material	Mount Color	Housing Material
80910	Clear	PC	Hardwired	Hardwired	Packard Connector 12010975	12	5.08/3.52	Steel	Black	PC

Right Hand Side

Part Number	Lens Color	Lens Material	Lamp Connection	Plug Side 1	Plug Side 2	Volts	Maps Major/Minor	Mount Material	Mount Color	Housing Material
80920	Clear	PC	Hardwired	Hardwired	Packard Connector 12010975	12	5.08/3.52	Steel	Black	PC

**SNOW PLOW, HALOGEN, 4"X 6",
1 STUD MOUNT, SIX POLE,
.180 BULLET MOLDED PLUG**



FEATURES

- High-impact polycarbonate and steel construction
- Features high beam/low beam halogen headlights and integrated park/turn lamps
- Lamp functions as a snow plow, all-terrain light or off-road/auxiliary light
- Mounts on one 1/2"-13 stud
- Kit also includes a switch, a grommet that protects wiring at the switch and a heavy-duty flasher
- One-piece harness runs from switch to the front of the vehicle and attaches with Scotch lock connectors

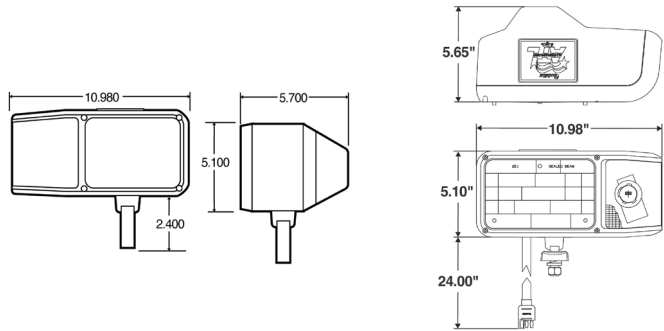

80800 - Kit

Part Number	Lens Color	Lens Material	Lamp Connection	Plug Side 1	Plug Side 2	Volts	Maps Major/Minor	Mount Material	Mount Color	Housing Material
80800	Clear	PC	Hardwired	Hardwired	Six Pole .180 Bullet Molded Plug	12	5.08/3.52	Steel	Black	PC



80800 Kit Includes
80810 light, 80820 light, 80830 harness, 80840 hardware

Left Hand Side

Part Number	Lens Color	Lens Material	Lamp Connection	Plug Side 1	Plug Side 2	Volts	Maps Major/Minor	Mount Material	Mount Color	Housing Material
80810	Clear	PC	Hardwired	Hardwired	Six Pole .180 Bullet Molded Plug	12	5.08/3.52	Steel	Black	PC

Right Hand Side

Part Number	Lens Color	Lens Material	Lamp Connection	Plug Side 1	Plug Side 2	Volts	Maps Major/Minor	Mount Material	Mount Color	Housing Material
80820	Clear	PC	Hardwired	Hardwired	Six Pole .180 Bullet Molded Plug	12	5.08/3.52	Steel	Black	PC

SNOW PLOW, HALOGEN, 4"X 6", 1 STUD MOUNT, UNIVERSAL, KIT

HALOGEN

SNOW PLOW



SNOW PLOW KIT



RIGHT-HAND SIDE

LEFT-HAND SIDE

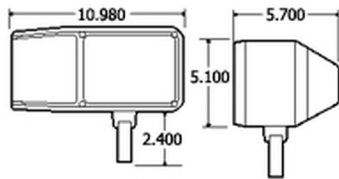

FEATURES

- Weatherproof connectors
- High-impact polycarbonate and steel construction
- Features high beam/low beam halogen headlights and integrated park/turn lamps
- Mounts on one 1/2" - 13 stud
- Lamp functions as snow plow, all-terrain light, or off-road/auxiliary light
- Kit also includes a switch, a grommet that protects wiring at the switch and a heavy-duty flasher
- One-piece harness runs from switch to the front of the vehicle and attaches with Packard weather proof connectors



Snow Plow Kit

Part Number	Lens Color	Lens Material	Lamp Connection	Plug Side 1	Plug Side 2	Volts	Maps Major/Minor	Mount Material	Mount Color	Housing Material
80805	Clear	PC	Hardwired	Hardwired	Packard Connector 12065158	12	5.08/3.52	Steel	Black	PC

(KIT)

80805 Kit Includes

80848 light, 80849 light, 80839 harness, 80840 hardware

Left Hand Side

Part Number	Lens Color	Lens Material	Lamp Connection	Plug Side 1	Plug Side 2	Volts	Maps Major/Minor	Mount Material	Mount Color	Housing Material
80848	Clear	PC	Hardwired	Hardwired	Packard Connector 12065158	12	5.08/3.52	Steel	Black	PC

Right Hand Side

Part Number	Lens Color	Lens Material	Lamp Connection	Plug Side 1	Plug Side 2	Volts	Maps Major/Minor	Mount Material	Mount Color	Housing Material
80849	Clear	PC	Hardwired	Hardwired	Packard Connector 12065158	12	5.08/3.52	Steel	Black	PC

**SNOW PLOW, HALOGEN, 4"X 6",
1 STUD MOUNT, SIX POLE,
.180 BULLET MOLDED PLUG,
UNIVERSAL, KIT**



FEATURES

- Incorporates complex reflector technology to help reduce driver fatigue
- Increased beam pattern output and improved beam pattern formation
- High-impact polycarbonate and steel construction
- Features high beam/low beam halogen headlights and integrated park/turn lamps
- Mounts on one 1/2" - 13 stud
- Lamp functions as a snow plow lights, all-terrain, or an off-road/auxiliary lights
- Kit also includes a switch and wiring harness kit

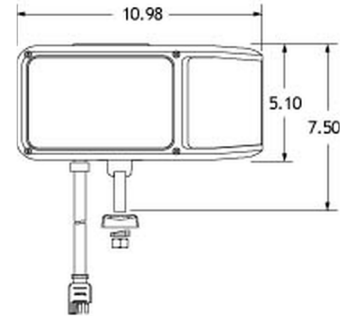

80893

Part Number	Lens Color	Lens Material	Lamp Connection	Plug Side 1	Plug Side 2	Volts	Maps Major/Minor	Mount Material	Mount Color	Housing Material
80893	Clear	Glass	Hardwired	Hardwired	Six Pole .180 Bullet Molded Plug	12	3.8/3.2	Steel	Black	PC



Replacement Parts
27010 light, 80831 harness, 80844 hardware

**SNOW PLOW, HALOGEN, 4"X 6",
1 STUD MOUNT, SIX POLE,
.180 BULLET MOLDED PLUG, ECONOMY, KIT**

HALOGEN

SNOW PLOW



SNOW PLOW KIT



RIGHT-HAND SIDE

LEFT-HAND SIDE

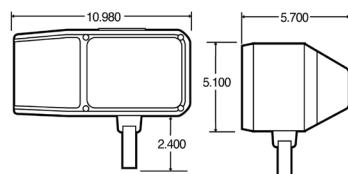

FEATURES

- High-impact polycarbonate and steel construction
- Features high beam/low beam halogen headlights and integrated park/turn lamps
- Mounts on one 1/2"-13 stud
- Lamp functions as snow plow, all-terrain or an off-road/auxiliary light
- Kit also includes a switch
- Two vehicle harnesses run from lamps and attach with twist-type connections



Snow Plow Kit

Part Number	Lens Color	Lens Material	Lamp Connection	Plug Side 1	Plug Side 2	Volts	Maps Major/Minor	Mount Material	Mount Color	Housing Material
80888	Clear	PC	Hardwired	Hardwired	Six Pole .180 Bullet Molded Plug	12	5.08/3.52	Steel	Black	PC



80900 Kit Includes
80860 light, 80870 light, 80831 harness, 80844 hardware

Left Hand Side

Part Number	Lens Color	Lens Material	Lamp Connection	Plug Side 1	Plug Side 2	Volts	Maps Major/Minor	Mount Material	Mount Color	Housing Material
80860	Clear	PC	Hardwired	Hardwired	Six Pole .180 Bullet Molded Plug	12	5.08/3.52	Steel	Black	PC

Right Hand Side

Part Number	Lens Color	Lens Material	Lamp Connection	Plug Side 1	Plug Side 2	Volts	Maps Major/Minor	Mount Material	Mount Color	Housing Material
80870	Clear	PC	Hardwired	Hardwired	Six Pole .180 Bullet Molded Plug	12	5.08/3.52	Steel	Black	PC

WARNING & EMERGENCY

WARNING LIGHTS

Pages 246-253

LED

Shape	Common Size	Page
ROUND		246-249
	1"	246
	2"	246
	4"	248-249
RECTANGULAR		249-253
	1.5 x 5"	249
	2 x 6 "	252-253
	4 x 2"	253

BEACONS

Pages 254-265

LED

Profile	Class	Page
HIGH	1	256
MEDIUM	1	257-262
	2	260
LOW	1	261-262
	2	262-264

HALOGEN

Profile	Class	Page
	1	265
	2	265

LIGHT BARS

Pages 266

LED

Common Size	Page
5 x 19"	266

GAS DISCHARGE

Common Size	Page
5 x 36"	266

HALOGEN

Common Size	Page
5 x 47"	266

TRAFFIC CONTROL LIGHT BARS

Page 267

INCANDESCENT

Common Size	Page
5 x 46"	267







Warning & Emergency

Developed through Truck-Lite’s experience in both LED design and heavy-duty warning lighting systems, these strobes and beacons offer rugged and dependable conspicuity regardless of the application.

<p>Mount type</p>	<p>Flange, Grommet, Surface, Stud, 1-Screw, 2-Screw, 4-Screw, Bracket, Magnetic, Permanent</p>
<p>Shapes</p>	<p>Strobe Round, oval, rectangular</p> <p>Beacon Low profile, medium profile, high profile</p>
<p>Classifications</p> <p>Before selecting any warning or safety lighting, it’s important to know the legal classifications for a given application.</p>	<p>Class I The brightest of all warning lighting, Class I lights most often appear on emergency vehicles, such as police cars, fire trucks and ambulances.</p> <p>Class II Class II warning lights produce no more than 25% of the intensity of Class I strobes and beacons. These usually appear on utility and construction vehicles.</p> <p>Class III Producing approximately 40% of the intensity of Class II strobes and beacons, Class III warning lights are typically used indoors, such as on a forklift.</p>

(800) 562-5012 | truck-lite.com

 <p>Manufacturing & Quality</p>	 <p>Testing & Safety</p>
<p>Truck-Lite's LED warning lighting is built using premium materials and backed by industry-leading warranties.</p> <p>Designed to last the life of your vehicle, Truck-Lite's solid-state construction and sealed circuitry mean that you can depend on your lights to withstand shock, vibration, moisture and debris.</p>	<p>All Truck-Lite warning and safety lighting is subjected to rigorous environmental, electrical and mechanical testing before they are validated and released to the market.</p>
 <p>Performance & Maintenance</p>	 <p>Customer Support</p>
<ul style="list-style-type: none"> • Lower energy consumption • Impact-resistant lenses and rugged housing protect against damage from even the toughest applications • Solid-state electronics designed for long-term dependability 	<div data-bbox="885 1228 957 1302"> </div> <p>Customer Service (800) 562-5012 customerservice@truck-lite.com</p> <div data-bbox="885 1449 957 1522"> </div> <p>Technical Support (888) 562-5012 tltech@truck-lite.com</p> <p>Warning & Emergency Warranties</p> <div data-bbox="869 1774 1300 1869"> </div>
<p>(800) 562-5012 truck-lite.com</p>	

LED
4 DIODE

**LED, 4 DIODE,
1", REMOTE, SELF CONTAINED,
FLANGE MOUNT**



FEATURES

- 25 selectable flash patterns
- Changeable colored lenses: yellow, blue and red
- Spherical LED heads are designed with diffusing optics for extremely wide-angle light output

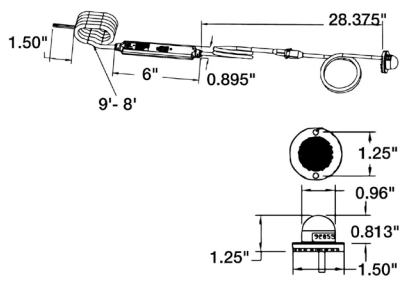

Part Number	Lens Color	Lamp Connector	Plug Side 1	Plug Side 2	Volts	Amps	Mount Color
92855	Clear	Hardwired	Hardwired	Stripped End	12 24	0.15	Silver

LED
30 SERIES

**30[®] SERIES, LED
3 DIODE, REMOTE,
SELF CONTAINED, GROMMET MOUNT**



FEATURES

- External power pack not required.
- Features internal circuitry to create self-flashing lamp.
- Flashes when power supplied (80 FPM).
- Not for standard marker applications, for auxiliary/strobe use only.
- Uses Fit 'N Forget connector for added corrosion & moisture resistance.
- Utilized to warn operator of fault conditions.

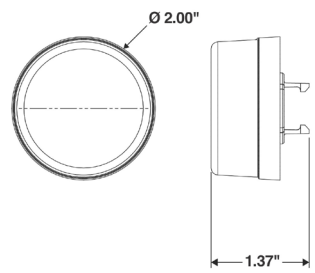

Part Number	Lens Color	Lamp Connector	Plug Side 1	Plug Side 2	Volts	Amps
30286Y	Yellow	Fit 'N Forget M/C	No Plug	No Plug	12	0.06
30286R	Red	Fit 'N Forget M/C	No Plug	No Plug	12	0.06

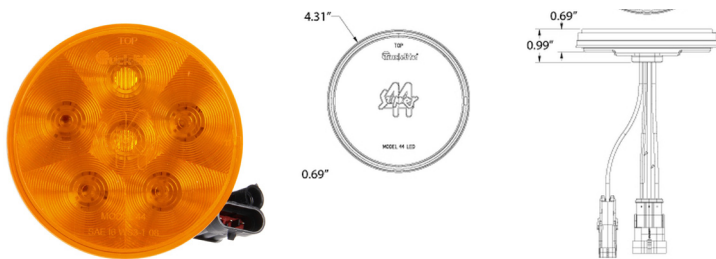

SUPER 44[®], LED
 6 DIODE, SELF CONTAINED,
 GROMMET MOUNT



LED
 SUPER 44

FEATURES

- Super 44 Series Rear Turn Strobe lamp provides a quad flash pattern with solid-state LED technology
- Turn signal override feature momentarily overrides strobe function allowing lamps to signal for turn functions
- Lateral system allows alternating flash patterns without the need of a separate box, saving on cost and additional installation time
- 6-Diode design meets turn signal requirements
- Fully encapsulated electronics and hard-wired design protect the lamp from corrosion and damage caused by chemicals and moisture
- Lamp design features a slim profile for mounting in areas of limited space
- Using 2 in-phase lamps or 2 out-phase lamps provide a synchronized flash, 1 in-phase lamp and 1 out-phase lamp provides alternating flash
- Features the Truck-Lite Limited Lifetime Warranty

Part Number	Lens Color	Lamp Connector	Plug Side 1	Plug Side 2	Volts	Amps	Warning Class	Phase
44110Y	Yellow	Hardwired	Hardwired	Packard Connector 282087/ Weather Connector 12015791	12	0.7	II	–
44217Y	Yellow	Hardwired	Hardwired	Packard Connector 282087/ Weather Connector 12015791	12	0.7	II	in-phase
44218Y	Yellow	Hardwired	Hardwired	Packard Connector 282087/ Weather Connector 12015791	12	0.7	II	out-phase
44114Y	Yellow	Hardwired	Hardwired	Stripped End	12	0.7	II	–
44248Y	Yellow	Hardwired	Hardwired	Blunt	12	0.7	II	in-phase
44249Y	Yellow	Hardwired	Hardwired	Blunt	12	0.7	II	out-phase

LED
SUPER 44

SUPER 44[®], LED
42 DIODE,
SELF-CONTAINED,
GROMMET MOUNT |
METALIZED



FEATURES

- External power pack not required
- Metalized reflector version offers more intense focused light
- Non-metalized version offers wider viewing angle
- Dual or quad flashing patterns
- Meets recommended SAE J1318 and J845 photometric specifications
- Synchronized alternating feature
- Lamp life rated at 100,000 hours
- Resistance to shock and vibration
- Fit 'N Forget™ adapter plug provides corrosion and moisture resistance
- Integral flange option features built-in lens

Part Number	Lens Color	Lamp Connector	Plug Side 1	Plug Side 2	Volts	Amps	Kit Includes	Metalized Reflector
44211Y	Yellow	Fit 'N Forget S.S.	-	-	12	0.5	-	No
44211R	Red	Fit 'N Forget S.S.	-	-	12	0.5	-	No
44101R	Red	Fit 'N Forget S.S.	Fit 'N Forget S.S.	Stripped End/Ring Terminal	12	0.5	44211R, 40700 grommet, 95220 plug	No
44101Y	Yellow	Fit 'N Forget S.S.	Fit 'N Forget S.S.	Stripped End/Ring Terminal	12	0.5	44211Y, 40700 grommet, 95220 plug	No
44212R	Red	Fit 'N Forget S.S.	-	-	12	0.5	-	Yes
44212Y	Yellow	Fit 'N Forget S.S.	-	-	12	0.5	-	Yes
44102Y	Yellow	Fit 'N Forget S.S.	Fit 'N Forget S.S.	Stripped End/Ring Terminal	12	0.5	44212Y, 40700 grommet, 95220 plug	Yes
44102R	Red	Fit 'N Forget S.S.	Fit 'N Forget S.S.	Stripped End/Ring Terminal	12	0.5	44212R, 40700 grommet, 95220 plug	Yes

(KIT)

(KIT)

(KIT)

(KIT)

LED
SUPER 44

SUPER 44[®], LED
42 DIODE, SELF CONTAINED,
FLANGE MOUNT | METALIZED

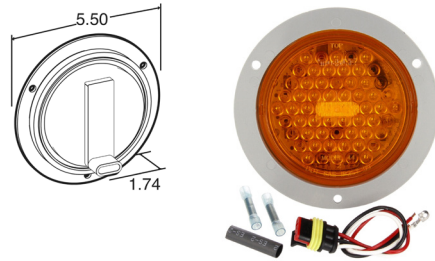

FEATURES

- External power pack not required
- Metalized reflector version offers more intense focused light
- Non-metalized version offers wider viewing angle
- Dual or quad flashing patterns
- Meets recommended SAE J1318 and J845 photometric specifications
- Synchronized alternating feature
- Lamp life rated at 100,000 hours
- Resistance to shock and vibration
- Fit 'N Forget™ adapter plug provides corrosion and moisture resistance
- Integral flange option features built-in lens

Part Number	Lens Colors	Plug Side 1	Plug Side 2	Volts	Amps	Mount Color	Kit Includes	Metalized
44213R	Red	-	-	12	0.5	Grey	-	No
44103R	Yellow	Fit 'N Forget S.S.	Stripped End/Ring Terminal	12	0.5	Grey	44213R lamp, 95220 plug	No
44213Y	Red	-	-	12	0.5	Grey	-	No
44103Y	Yellow	Fit 'N Forget S.S.	Stripped End/Ring Terminal	12	0.5	Grey	44213Y lamp, 95220 plug	No
44214R	Red	-	-	12	0.5	Grey	-	Yes
44104R	Yellow	Fit 'N Forget S.S.	Stripped End/Ring Terminal	12	0.5	Grey	44214R lamp, 95220 plug	Yes
44214Y	Red	-	-	12	0.5	Grey	-	Yes
44104Y	Yellow	Fit 'N Forget S.S.	Stripped End/Ring Terminal	12	0.5	Grey	44214Y lamp, 95220 plug	Yes

(KIT)

(KIT)

(KIT)

(KIT)

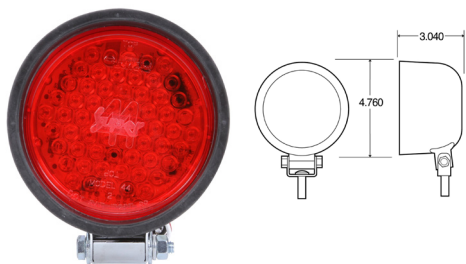

SUPER 44[®], LED

LED, 42 DIODE, SELF CONTAINED,
1 STUD MOUNT

FEATURES

- Durable synthetic rubber housing resists corrosion
- Includes mounting hardware
- Mounts on 5/16 - 18 stud
- External power pack or control module not required
- Meets SAE J1318 and J845 photometric specifications
- Synchronized alternating feature



Part Number	Lens Color	Lamp Connector	Plug Side 1	Plug Side 2	Volts	Amps	Mount Color
44216R	Red	Fit 'N Forget S.S.	Fit 'N Forget S.S.	.180 Bullet/Ring Terminal	12	0.57	Black
44216Y	Yellow	Fit 'N Forget S.S.	Fit 'N Forget S.S.	.180 Bullet/Ring Terminal	12	0.57	Black

LED
SUPER 44

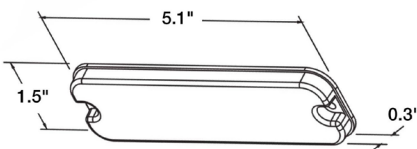
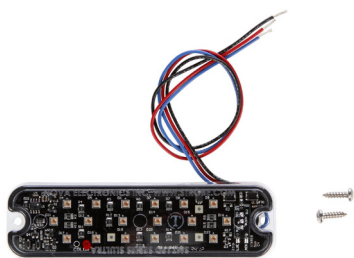

LED, 18 DIODE,

1.5"X5", SELF CONTAINED,
SURFACE MOUNT

FEATURES

- 16 flash patterns including random
- 18 high-intensity LEDs
- Encapsulated electronics extend product life
- Synchronization capable



Part Number	Lens Color	Lamp Connector	Plug Side 1	Plug Side 2	Volts	Amps	Mount Color	Warning Class
92872R	Clear Red	Hardwired	Hardwired	Stripped End	12	0.5	Clear	I
92872Y	Clear Yellow	Hardwired	Hardwired	Stripped End	12	0.5	Clear	I
92872B	Clear Blue	Hardwired	Hardwired	Stripped End	12	0.5	Clear	I
92872C	Clear Clear	Hardwired	Hardwired	Stripped End	12	0.5	Clear	I

LED
18 DIODE

REDUCE THE RISK OF REAR-END COLLISIONS BY **UP TO 34%***

The Federal Motor Carrier Safety Administration (FMCSA) has granted tank trailer operators the ability to install brake-activated pulsating lamps on the rear of their trailer in order to increase visibility and reduce the risk of rear-end collisions.

In addition to traditional tail lamps, Truck-Lite's variety of red and amber warning lights provide the visibility and durability you need to take advantage of this new ruling – and help keep your fleet safer on the road.

**Fleet Owner, June 1, 2020*



60364Y

FMCSA RULING

Docket Number: FMCSA-2019-0260

Document Number: 2020-22233

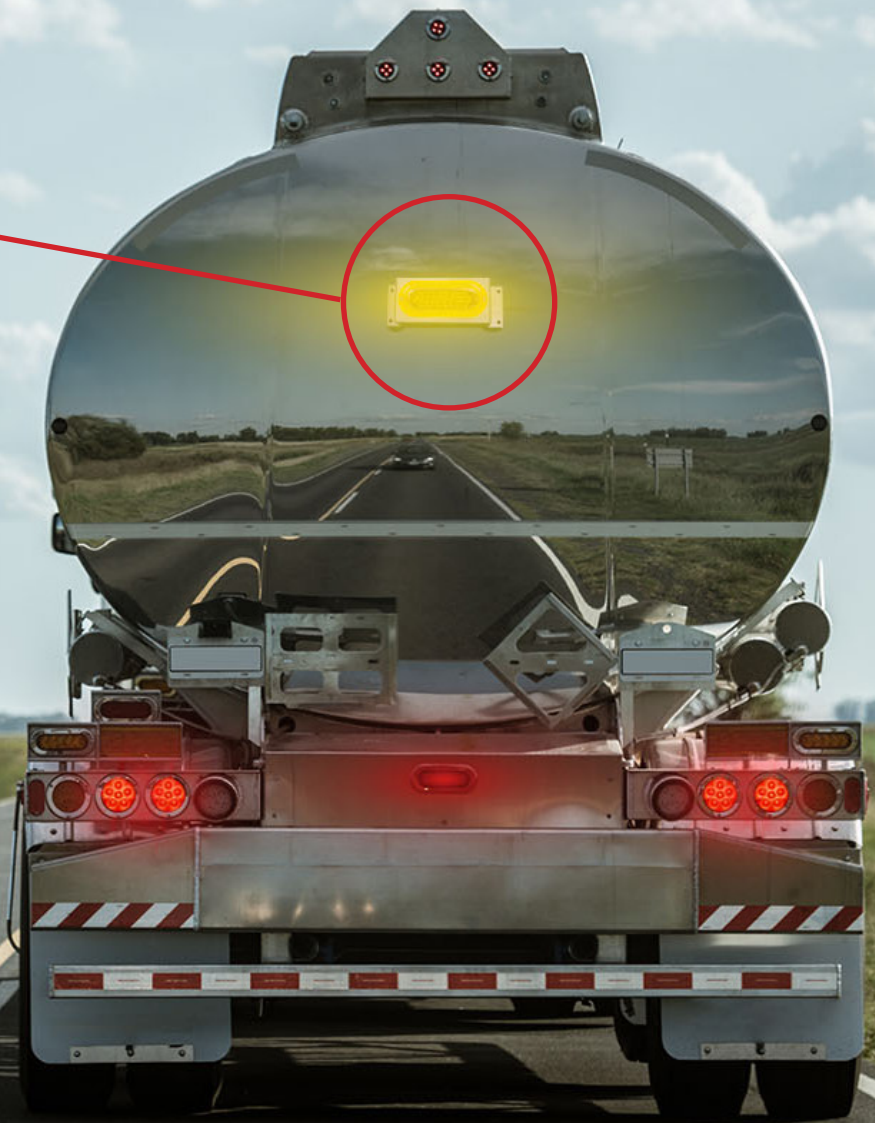

Warning Lights/Accessories

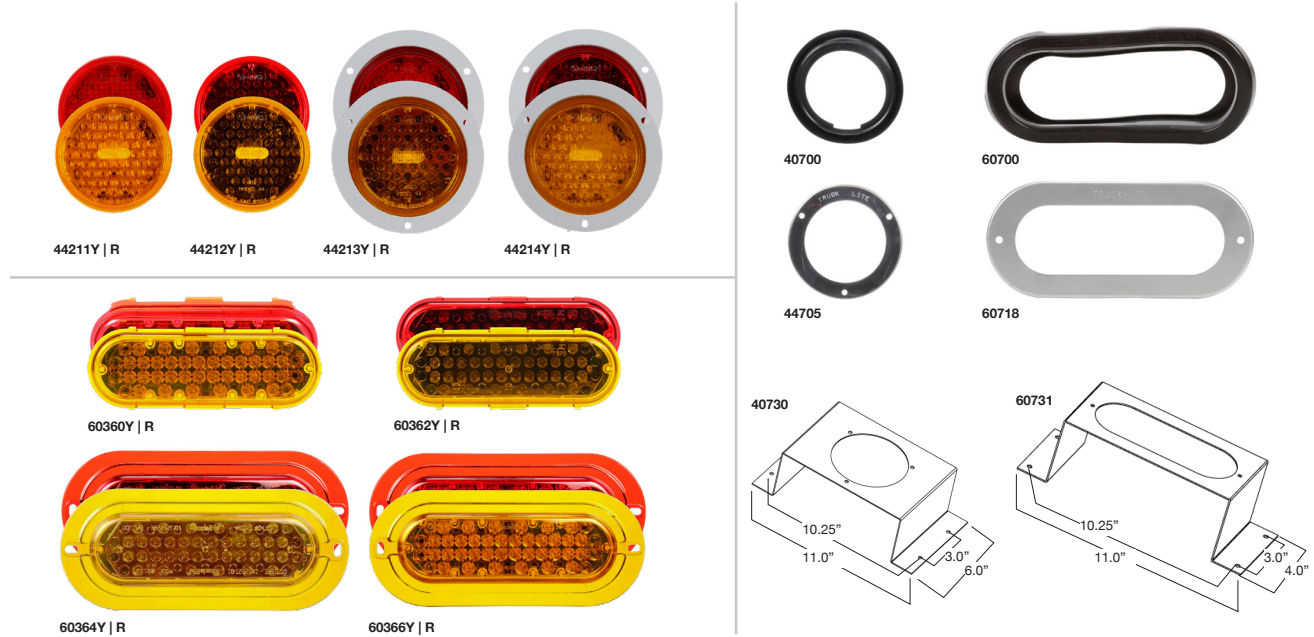

Part No.	PG.	Truck-Lite LED Warning Lamp Options
44211Y 44211R	246	Super 44, LED Warning, 42 Diode, Yellow Red, Fit N' Forget SS, 12V
44212Y 44212R	246	Super 44, LED Warning, 42 Diode, Yellow Red, Metalized, Fit N' Forget SS, 12V
44213Y 44213R	246	Super 44, LED Warning, 42 Diode, Yellow Red, Fit N' Forget SS, 12V, Flange
44214Y 44214R	246	Super 44, LED Warning, 42 Diode, Yellow Red, Metalized, Fit N' Forget SS, 12V, Flange
60360Y 60360R	250	Super 60, LED Warning, 36 Diode, Yellow Red, Class II, Fit N' Forget SS, 12V
60362Y 60362R	250	Super 60, LED Warning, 36 Diode, Yellow Red, Class II, Metalized, Fit N' Forget SS, 12V
60364Y 60364R	250	Super 60, LED Warning, 36 Diode, Yellow Red, Class II, Metalized, Fit N' Forget SS, 12V, Flange
60366Y 60366R	250	Super 60, LED Warning, 36 Diode, Yellow Red, Class II, Fit N' Forget SS, 12V, Flange

Lamps with a metalized reflector offer more intense, focused light while non-metalized versions offer a wider viewing angle.

Part No.	Truck-Lite Pigtail/Adapter Options
83516	PL-3 Jumper w/ .180 Receptacle
83517	Male Pin Jumper w/ .180 Receptacles
83518	Fit N' Forget Jumper w/ .180 Receptacles



PL-3



Male-Pin



Fit 'N Forget

Part No.	Truck-Lite Harnessing Options
89324 0300	88 Series, 3-Conductor, Red/White/Black, 14AWG, .180 Bullet w/ 3-Position Sure Seal, 300 in.
52312 0300	88 Series, 3-Conductor, Red/White/Black, 14AWG, #10 Eye Ring w/ 3-Position Sure Seal, 300 in.

Part No.	PG.	Truck-Lite Mounting Options
40700	353	4" Round Grommet
60700	354	2"x6" Grommet
44705	337	4" Round Stainless Steel Flange Cover
60718	341	2"x6" Stainless Steel Flange Cover

Part No.	PG.	Truck-Lite Mounting Options (continued)
40730	338	Model 44 Stainless Steel Mounting Bracket
60731	340	Model 60 Stainless Steel Mounting Bracket

LED

SUPER 60

SUPER 60[®], LED

2X6", 36 DIODE, SELF CONTAINED,
GROMMET MOUNT | METALIZED



FEATURES

- External power pack not required
- Metalized reflector version offers more intense focused light
- Non-metalized version offers wider viewing angle
- Dual or quad flashing patterns
- Meets recommended SAE J1318 and J845 photometric specifications
- Synchronized alternating feature
- Lamp life rated at 100,000 hours
- Resistance to shock and vibration
- Fit 'N Forget™ adapter plug provides corrosion and moisture resistance
- Integral flange option features built-in lens

Part Number	Lens Color	Lamp Connector	Plug Side 1	Plug Side 2	Volts	Amps	Mount Color	Warning Class	Kit Includes	Metalized
60362R	Red	Fit 'N Forget S.S.	-	-	12	0.5	Black	II	-	Yes
60120R	Red	Fit 'N Forget S.S.	Fit 'N Forget S.S.	Stripped End/Ring Terminal	12	0.5	Black	II	60362R lens, 60700 grommet, 95220 plug	Yes
60362Y	Yellow	Fit 'N Forget S.S.	-	-	12	0.5	Black	II	-	Yes
60120Y	Yellow	Fit 'N Forget S.S.	Fit 'N Forget S.S.	Stripped End/Ring Terminal	12	0.5	Black	II	60362Y lens, 60700 grommet, 95220 plug	Yes
60360R	Red	Fit 'N Forget S.S.	-	-	12	0.5	Black	II	-	No
60122R	Red	Fit 'N Forget S.S.	Fit 'N Forget S.S.	Stripped End/Ring Terminal	12	0.5	Black	II	60360R lens, 60700 grommet, 95220 plug	No
60360Y	Yellow	Fit 'N Forget S.S.	-	-	12	0.5	Black	II	-	No
60122Y	Yellow	Fit 'N Forget S.S.	Fit 'N Forget S.S.	Stripped End/Ring Terminal	12	0.5	Black	II	60360Y lens, 60700 grommet, 95220 plug	No

LED

SUPER 60

SUPER 60[®], LED

2X6", 36 DIODE, SELF CONTAINED,
FLANGE MOUNT | METALIZED

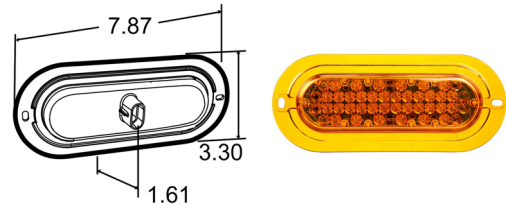

FEATURES

- External power pack not required
- Metalized reflector version offers more intense focused light
- Non-metalized version offers wider viewing angle
- Dual or quad flashing patterns
- Meets recommended SAE J1318 and J845 photometric specifications
- Synchronized alternating feature
- Lamp life rated at 100,000 hours
- Resistance to shock and vibration
- Fit 'N Forget™ adapter plug provides corrosion and moisture resistance
- Integral flange option features built-in lens

Part Number	Lens Color	Lamp Connector	Plug Side 1	Plug Side 2	Volts	Amps	Mount Color	Warning Class	Kit Includes	Metalized
60364R	Red	Fit 'N Forget S.S.	-	-	12	0.5	Same as lens	II	-	Yes
60124R	Red	Fit 'N Forget S.S.	Fit 'N Forget S.S.	Stripped End/Ring Terminal	12	0.5	Same as lens	II	60364R lens, 95220 plug	Yes
60364Y	Yellow	Fit 'N Forget S.S.	-	-	12	0.5	Same as lens	II	-	Yes
60124Y	Yellow	Fit 'N Forget S.S.	Fit 'N Forget S.S.	Stripped End/Ring Terminal	12	0.5	Same as lens	II	60364Y lens, 95220 plug	Yes
60366R	Red	Fit 'N Forget S.S.	-	-	12	0.5	Same as lens	II	-	No
60126R	Red	Fit 'N Forget S.S.	Fit 'N Forget S.S.	Stripped End/Ring Terminal	12	0.5	Same as lens	II	60366R lens, 95220 plug	No
60366Y	Yellow	Fit 'N Forget S.S.	-	-	12	0.5	Same as lens	II	-	No
60126Y	Yellow	Fit 'N Forget S.S.	Fit 'N Forget S.S.	Stripped End/Ring Terminal	12	0.5	Same as lens	II	60366Y lens, 95220 plug	No

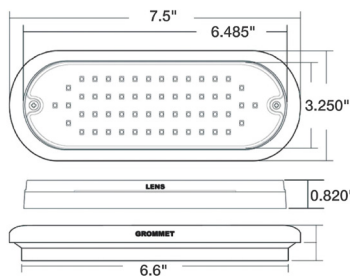

**LED, 56 DIODE,
2"X6", SELF CONTAINED,
SURFACE MOUNT**

FEATURES

- 15 flash patterns including random
- 56 high-intensity LEDs
- Extremely thin design



Part Number	Lens Color	Lamp Connector	Plug Side 1	Plug Side 2	Volts	Amps	Mount Color	Warning Class
92873Y	Clear Yellow	Hardwired	Hardwired	Stripped End	12	0.8	Black	I
92875R	Clear Red	Hardwired	Hardwired	Stripped End	12	0.8	Clear	I
92875Y	Clear Yellow	Hardwired	Hardwired	Stripped End	12	0.8	Clear	I

(KIT)

LED

56 DIODE

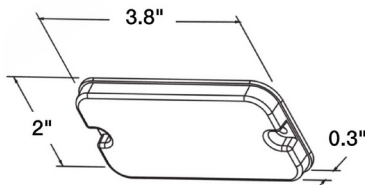
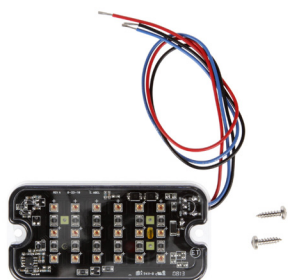

**LED, 18 DIODE,
4"X2", SELF CONTAINED,
SURFACE MOUNT**

FEATURES

- 16 flash patterns including random
- 18 high-intensity LEDs
- Encapsulated electronics extend product life
- Synchronization capable



Part Number	Lens Color	Lamp Connector	Plug Side 1	Plug Side 2	Volts	Amps	Mount Color	Warning Class
92871R	Clear Red	Hardwired	Hardwired	Stripped End	12	0.5	Clear	I
92871Y	Clear Yellow	Hardwired	Hardwired	Stripped End	12	0.5	Clear	I
92871B	Clear Blue	Hardwired	Hardwired	Stripped End	12	0.5	Clear	I
92871C	Clear	Hardwired	Hardwired	Stripped End	12	0.5	Clear	I

LED

18 DIODE



MASTER TRAINING

The Truck-Lite Training Institute offers lighting and harness education to technicians.

Online courses are FREE and available 24/7.



www.truck-lite.com/tti



DEDICATED SUPPORT.

When you have questions, Truck-Lite
customer service and technical support
have answers.



Customer Service

 (800) 562-5012



Technical Support

 (888) 562-5012



LED

CLASS 1

LED, HIGH PROFILE, CLASS 1, PERMANENT MOUNT



FEATURES

- 24 different selectable flash patterns, plus steady-on
- Pattern select wire to change patterns
- Fully encapsulated circuitry for weather and shock resistance
- Clear dust cover seals out dirt and for easy cleaning
- Heavy duty spun aluminum base with plastic base insert
- Mounts easily with two toggle bolts on 3-1/2" centers
- Meets California title 13

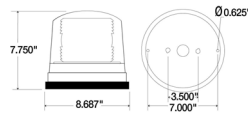

Part Number	Lens Color	Plug Side 2	Volts	Amps Major/Minor	Warning Class	Selectable Flash Patterns (Y/N)
92865Y	Yellow	Stripped End	12 24	0.41	I	Yes

LED

CLASS 1

LED, HIGH PROFILE , CLASS 1, PERMANENT MOUNT



FEATURES

- 24 different selectable flash patterns, plus steady-on
- Pattern select wire to change patterns
- Clear dust cover seals out dirt and for easy cleaning
- Heavy duty spun aluminum base with plastic base insert
- Mounts easily with two toggle bolts on 3-1/2" centers

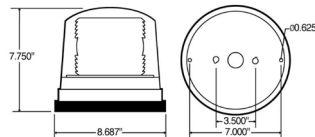

Part Number	Lens Color	Plug Side 2	Volts	Amps Major/Minor	Warning Class	Selectable Flash Patterns (Y/N)
92513Y	Yellow	Stripped End	10-30	0.6	I	Yes

**LED, MEDIUM PROFILE,
CLASS 1, PERMANENT MOUNT**

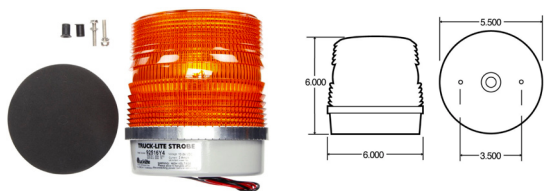

FEATURES

- 24 different selectable flash patterns, plus steady-on
- Pattern select wire to change patterns
- Fully encapsulated circuitry for weather and shock resistance
- Low current draw
- Rugged die-cast aluminum base with powder coated finish
- Mounts with 1/2" conduit pipe and includes knock-outs for permanent surface



Part Number	Lens Color	Plug Side 2	Volts	Amps Major/Minor	Warning Class	Selectable Flash Patterns (Y/N)
92516Y	Yellow	Stripped End	10-30	0.6	I	Yes

LED

CLASS 1

**LED, MEDIUM PROFILE,
CLASS 1, PERMANENT MOUNT**

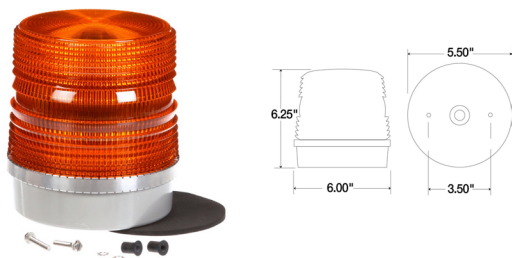

FEATURES

- 24 different selectable flash patterns, plus steady-on
- Pattern select wire to change patterns
- Fully encapsulated circuitry for weather and shock resistance
- Low current draw
- Rugged die-cast aluminum base with powder coated finish
- Mounts with 1/2" conduit pipe and includes knock-outs for permanent surface
- Meets California title 13



Part Number	Lens Color	Plug Side 2	Volts	Amps Major/Minor	Warning Class	Selectable Flash Patterns (Y/N)
92864Y	Yellow	Stripped End	10-30	0.6	I	Yes

LED

CLASS 1

LED
CLASS 1

**LED, MEDIUM PROFILE,
CLASS 1, PERMANENT MOUNT, PIPE MOUNT**



FEATURES

- Optics designed specifically for LED technology, not as a gaseous discharge retrofit
- Additional color options excellent option for City/County Municipal, Cement Mixer, and other Heavy-Duty, Construction or Off-Road Applications
- Dual and Quad Class I flash patterns meet legal functions
- Rugged black powder coated corrosion-resistant die-cast aluminum base
- Designed for Surface Mount as well as Pipe Mount (1NPT pipe thread)
- Electronics and Light Source are fully encapsulated in epoxy to protect components from moisture damage and corrosives
- Protected against industry-standard electrical transient per SAE J1455
- Linear supply offers reduced EMI over that of gaseous discharge systems
- Threaded-lens design does not require tool to replace lens
- Designed without external optics to reduce maintenance and cleaning
- Mounting gasket and #10 installation screws included
- Cigarette Plug features On/Off switch with LED indicator light

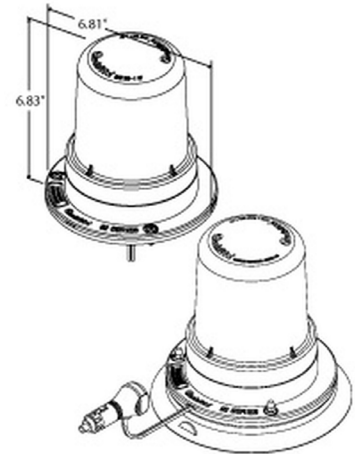

Part Number	Lens Color	Plug Side 2	Volts	Amps Major/Minor	Warning Class	Selectable Flash Patterns (Y/N)
92565Y	Yellow	Stripped End	12	2.6	I	No
92565R	Red	Stripped End	12	2.6	I	Yes
92565B	Blue	Stripped End	12	2.6	I	Yes
92565C	Clear	Stripped End	12	2.6	I	Yes
92566Y	Yellow Clear	Stripped End	12	2.6	I	No
92568Y	Yellow	Stripped End	24	1.3	I	Yes
92568R	Red	Stripped End	24	1.3	I	Yes
92568C	Clear	Stripped End	24	1.3	I	Yes

LED
CLASS 1

**LED, MEDIUM PROFILE,
CLASS 1, PERMANENT MOUNT, PIPE MOUNT**

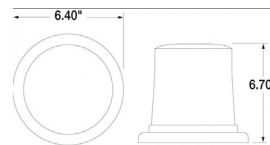

FEATURES

- 12 selectable flash patterns, plus steady-on, and includes rotating
- Fully encapsulated circuitry for weather and shock resistance
- Flange 3 hole permanent mount base with 1" pipe mount
- Twist on/off lens

Part Number	Lens Color	Plug Side 2	Volts	Amps Major/Minor	Warning Class	Selectable Flash Patterns (Y/N)
92860Y	Yellow	Stripped End	10-30	0.6	I	Yes

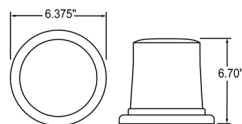

**LED, MEDIUM PROFILE,
CLASS 1, PERMANENT MOUNT, PIPE MOUNT**



FEATURES

- 26 selectable flash patterns, including steady-on
- Pattern select wire to change patterns
- Flange 3 hole permanent mount base with 1" pipe mount
- Twist on/off lens
- Low current draw

Part Number	Lens Color	Plug Side 2	Volts	Amps Major/Minor	Warning Class	Selectable Flash Patterns (Y/N)
6811A	Yellow	Cigarette Adapter	12	2 / 0.5	I	Yes

SIGNAL-STAT

CLASS 1

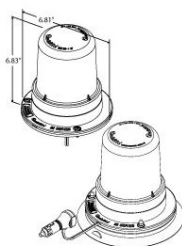

**LED, MEDIUM PROFILE,
CLASS 1, MAGNETIC MOUNT**



FEATURES

- Dual and Quad Class I flash patterns meet legal functions
- Rugged black powder coated corrosion-resistant die-cast aluminum base
- Electronics and Light Source are fully encapsulated in epoxy to protect components from moisture damage and corrosives
- Protected against industry-standard electrical transient per SAE J1455
- Linear supply offers reduced EMI over that of gaseous discharge systems
- Designed without external optics to reduce maintenance and cleaning
- Mounting gasket and #10 installation screws included
- Magnetic Mount constructed of high-quality aluminum covered in a protective rubber, featuring neodymium magnets with up to 120 pounds of magnetic pull

Part Number	Lens Color	Plug Side 2	Volts	Amps Major/Minor	Warning Class	Selectable Flash Patterns (Y/N)
92569Y	Yellow	Cigarette Adapter	12	2.6	I	Yes

LED

CLASS 1

LED
CLASS 1

**LED, MEDIUM PROFILE,
CLASS 1, MAGNETIC MOUNT**



FEATURES

- 12 selectable flash patterns, plus steady-on, and includes rotating
- Fully encapsulated circuitry for weather and shock resistance
- Vacuum magnet mount w/ pattern select cig plug
- Twist on/off lens

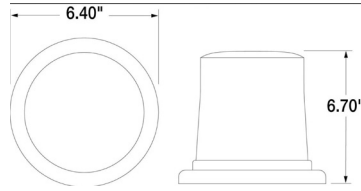

Part Number	Lens Color	Plug Side 2	Volts	Amps Major/Minor	Warning Class	Selectable Flash Patterns (Y/N)
92861Y	Yellow	Cigarette Adapter	12	0.6	I	Yes

SIGNAL-STAT
CLASS 2

**LED, MEDIUM PROFILE,
CLASS 2, PERMANENT MOUNT, PIPE MOUNT**



FEATURES

- 26 selectable flash patterns, including steady-on
- Pattern select wire to change patterns
- Flange 3 hole permanent mount base with 1" pipe mount
- Twist on/off lens
- Low current draw

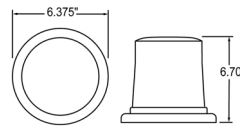

Part Number	Lens Color	Plug Side 2	Volts	Amps Major/Minor	Warning Class	Selectable Flash Patterns (Y/N)
6601A	Yellow	Stripped End	10-30	2 / 0.35	II	Yes

SIGNAL-STAT
CLASS 2

**LED, MEDIUM PROFILE,
CLASS 2, MAGNETIC MOUNT**



FEATURES

- 24 different selectable flash patterns, plus steady-on
- Pattern select wire to change patterns
- Low current draw
- Flange 3 hole permanent mount base with 1" pipe mount
- Twist on/off lens

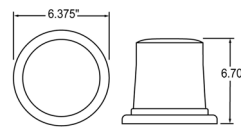

Part Number	Lens Color	Plug Side 2	Volts	Amps Major/Minor	Warning Class	Selectable Flash Patterns (Y/N)
6601MA	Yellow	Cigarette Adapter	10-30	2 / 0.5	II	Yes

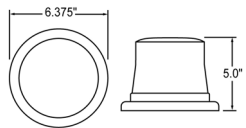

**LED, LOW PROFILE,
CLASS 1, PERMANENT MOUNT, PIPE MOUNT**



FEATURES

- 24 selectable flash patterns, including steady-on
- Pattern select wire to change patterns
- Low current draw
- Flange 3 hole permanent mount base with 1" pipe mount
- Twist on/off lens

Part Number	Lens Color	Plug Side 2	Volts	Amps Major/Minor	Warning Class	Selectable Flash Patterns (Y/N)
6810A	Yellow	Stripped End	10-30	0.5	I	Yes

LED
CLASS 1

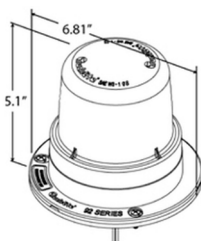

**LED, LOW PROFILE,
CLASS 1, PERMANENT MOUNT, PIPE MOUNT**



FEATURES

- Optics designed specifically for LED technology, not as a gaseous discharge retrofit
- Dual and quad flash patterns meet legal functions
- Rugged black powder coated corrosion-resistant die-cast aluminum base
- Designed for surface mount as well as pipe mount (1" NPT pipe thread)
- Electronics and light source are fully encapsulated in epoxy
- Protected against industry-standard electrical transient per SAE J1455
- Linear supply offers reduced EMI over that of gaseous discharge systems
- Threaded-lens design does not require tool to replace lens
- Designed without external optics to reduce maintenance and cleaning
- Mounting gasket and #10 installation screws included

Part Number	Lens Color	Plug Side 2	Volts	Amps Major/Minor	Warning Class	Selectable Flash Patterns (Y/N)
92564C	Clear	Stripped End	12	2.2	I	No
92564Y	Yellow	Stripped End	12	2.2	I	No

LED
CLASS 1

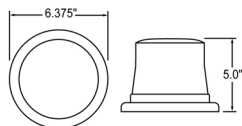

**LED, LOW PROFILE,
CLASS 1, MAGNETIC MOUNT**



FEATURES

- 24 selectable flash patterns, including steady-on
- Vacuum magnet mount w/ pattern select cig plug
- Twist on/off lens
- Low current draw

Part Number	Lens Color	Plug Side 2	Volts	Amps Major/Minor	Warning Class	Selectable Flash Patterns (Y/N)
6810MA	Yellow	Cigarette Adapter	12	0.5	I	Yes

LED
CLASS 1

LED

CLASS 1

**LED, LOW PROFILE,
CLASS 1, PERMANENT MOUNT, PIPE MOUNT**



FEATURES

- 12 selectable flash patterns, plus steady-on, and includes rotating
- Fully encapsulated circuitry for weather and shock resistance
- Flange 3 hole permanent mount base with 1" pipe mount
- Twist on/off lens

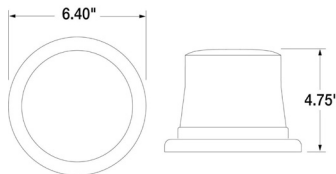

Part Number	Lens Color	Plug Side 2	Volts	Amps Major/Minor	Warning Class	Selectable Flash Patterns (Y/N)
92862Y	Yellow	Stripped End	10-30	0.6	I	No

LED

CLASS 1

**LED, LOW PROFILE,
CLASS 1, MAGNETIC MOUNT**



FEATURES

- 12 selectable flash patterns, plus steady-on, and includes rotating
- Fully encapsulated circuitry for weather and shock resistance
- Vacuum magnet mount w/ pattern select cig plug
- Twist on/off lens(manual and automatic)

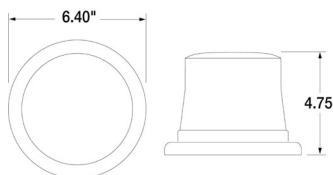

Part Number	Lens Color	Plug Side 2	Volts	Amps Major/Minor	Warning Class	Selectable Flash Patterns (Y/N)
92863Y	Yellow	Cigarette Adapter	12	0.6	I	Yes

LED

CLASS 2

**LED, LOW PROFILE,
CLASS 2, PERMANENT MOUNT**



FEATURES

- 26 selectable flash patterns, including steady-on
- Pattern select wire to change patterns
- Flange permanent mount
- Twist on/off lens
- 5.) low current draw

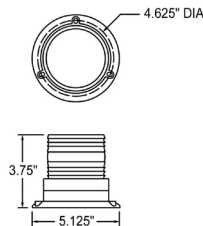

Part Number	Lens Color	Plug Side 2	Volts	Amps Major/Minor	Warning Class	Selectable Flash Patterns (Y/N)
307AL	Yellow	Stripped End	10-110	0.35	II	Yes

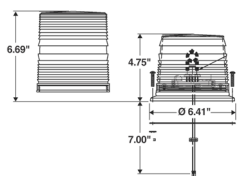

**LED, LOW PROFILE,
CLASS 2, PERMANENT MOUNT, PIPE MOUNT**



FEATURES

- 26 selectable flash patterns, including steady-on
- Pattern select wire to change patterns
- Flange 3 hole permanent mount base with 1" pipe mount
- Twist on/off lens
- Low current draw

Part Number	Lens Color	Plug Side 2	Volts	Amps Major/Minor	Warning Class	Selectable Flash Patterns (Y/N)
6600A	Yellow	Stripped End	12	0.35	II	Yes

LED

CLASS 2

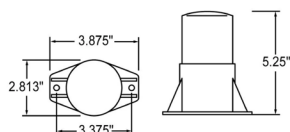

**LED, LOW PROFILE,
CLASS 2, PERMANENT MOUNT, PIPE MOUNT**



FEATURES

- 26 selectable flash patterns, including steady-on
- Pattern select wire to change patterns
- Flange permanent mount
- Twist on/off lens
- Low current draw

Part Number	Lens Color	Plug Side 2	Volts	Amps Major/Minor	Warning Class	Selectable Flash Patterns (Y/N)
92560	Yellow	Stripped End	10-110	0.35	II	No

LED

CLASS 2

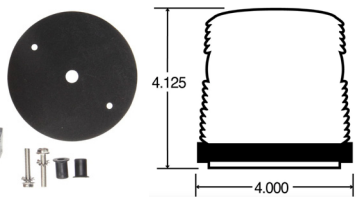

**LED, LOW PROFILE,
CLASS 2, PERMANENT MOUNT, PIPE MOUNT**



FEATURES

- 26 selectable flash patterns, including steady-on
- Pattern select wire to change patterns
- Permanent mount base with 1/2" pipe mount
- Snap-on polycarbonate lens
- ABS plastic base

Part Number	Lens Color	Plug Side 2	Volts	Amps Major/Minor	Warning Class	Selectable Flash Patterns (Y/N)
92534Y	Yellow	Stripped End	10-30	5.0/0.04	II	No

LED

CLASS 2

LED

CLASS 1

**LED, LOW PROFILE,
CLASS 2, MAGNETIC MOUNT**



FEATURES

- 26 selectable flash patterns, including steady-on
- Vacuum magnet mount w/ pattern select cig plug
- Twist on/off lens
- Low current draw

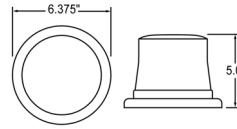

Part Number	Lens Color	Plug Side 2	Volts	Amps Major/Minor	Warning Class	Selectable Flash Patterns (Y/N)
6600MA	Yellow	Cigarette Adapter	12	0.35	II	Yes

LED

CLASS 2

**LED, LOW PROFILE,
CLASS 2 MAGNETIC MOUNT**



FEATURES

- 26 selectable flash patterns, including steady-on
- Pattern select wire to change patterns
- Magnet mount with pattern select cig plug
- Twist on/off lens
- 5.) low current draw

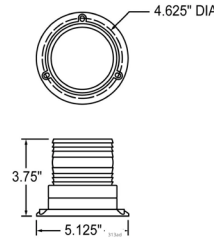

Part Number	Lens Color	Plug Side 2	Volts	Amps Major/Minor	Warning Class	Selectable Flash Patterns (Y/N)
313AL	Yellow	Cigarette Adapter	10-110	0.1	II	No

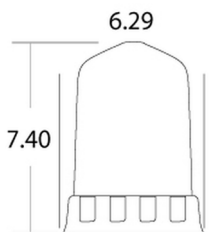

**HALOGEN,
CLASS 1, MAGNETIC MOUNT,
ROTATING**



FEATURES

- Rubbolite M153 series and approved rotating halogen beacons
- Magnetic mount with cigarette plug adapter
- 3-bolt mounting with 16 gauge wire

Part Number	Lens Color	Plug Side 2	Volts	Warning Class	Selectable Flash Patterns (Y/N)
6823A	Yellow	Cigarette Adapter	12	I	No

HALOGEN

CLASS 1

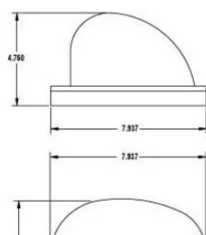

**HALOGEN,
CLASS 2, MAGNETIC MOUNT**



FEATURES

- Truck-Lite has replaced revolving beacon 333/333A to an upgraded version, 92602R/92602Y
- Meets Class 1, SAE J845
- Improved rotating gear drive mechanism for quieter operation
- Improved dual magnetic mounting, less prone to scratch vehicle paint
- Rate RPM: 120 +/- 5/minute
- Temperature Range: -4° F to 122° F

Part Number	Lens Color	Plug Side 2	Volts	Amps Major/Minor	Warning Class	Selectable Flash Patterns (Y/N)
92602B	Blue	Cigarette Adapter	12	3.5	II	No
92602Y	Yellow	Cigarette Adapter	12	3.5	II	No
92620Y	Yellow	Cigarette Adapter	12	1.7	II	No

HALOGEN

CLASS 2

LED

LIGHT BAR

**LED, 5" X 19",
PERMANENT MOUNT**



FEATURES

- Compact and quiet operation
- LED version features 20 selectable flash patterns via external pattern
- Select wire or internal jumper

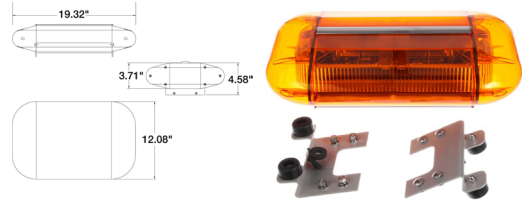

Part Number	Lens Color	Plug Side 2	Volts	Amps	Lens Material	Housing Material	Warning Class
92866Y	Yellow	Stripped End	12 24	2.3	PC	Aluminum	I

HALOGEN

LIGHT BAR

**HALOGEN, 5" X 47",
MAGNETIC MOUNT**



FEATURES

- Features dual decks for power and flexibility
- Extruded aluminum frame will not warp or bend
- Meets SAE J1318 Class I requirements
- Built-in rear traffic director
- H1 55W halogen rotating assemblies
- 18' harness exits on driver's side
- Dimensions: 5.75" H x 12.25" W

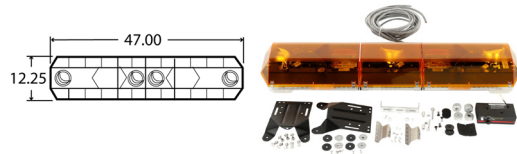

Part Number	Lens Color	Plug Side 2	Volts	Amps	Lens Material	Housing Material	Warning Class
92677Y	Yellow	Blunt Cut	12	8	PC	PC	I

GAS DISCHARGE

LIGHT BAR

**GAS DISCHARGE,
5" X 36", PERMANENT MOUNT**



FEATURES

- Halogen version includes two halogen rotators, two fast halogen rotators and two double mirrors
- Features two 360° strobe heads, one 2-head strobe, two double mirrors
- Linear strobe version features four 4.5" linear strobe heads, four 7" linear strobe heads, two 4 head strobe's
- Compact unit operates quietly
- 110 FPM, 2 amp draw
- Review installation instructions and warning labels for proper use

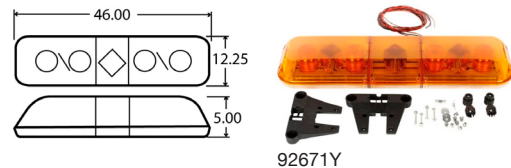

92671Y

Part Number	Lens Color	Plug Side 2	Volts	Amps	Lens Material	Housing Material
92671Y	Yellow	Stripped End	12	8.6	PC	PC

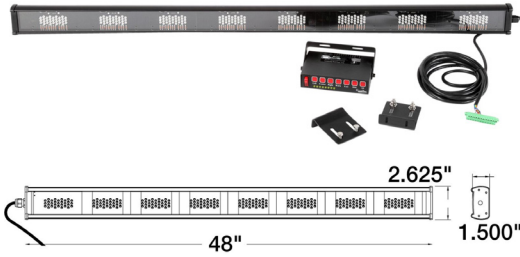

**LED,
LED, TRAFFIC CONTROL
LIGHT BAR MODULE**



FEATURES

- Sealed design provides extreme weather resistance
- Control unit is operated with a combined circuit
- Highly efficient LED optics
- Control unit is micro-processor controlled with tactile front
- Heavy duty housing is resistant to warping, bending and/or corroding

Part Number	Lens Color	Plug Side 2	Volts	Amps	Lens Material	Housing Material
92868Y	Clear Yellow	Control Unit Connector	12	2.1	PC	Aluminum

INTERIOR UTILITY & DOME LIGHTS

Shape	Common Size	Page
ROUND		270-279
	0.75"	270-273
	1"	273
	2"	274
	2.5"	275
	4"	275-278
	5"	278
	7"	279
RECTANGULAR		279-285
	1 x 2"	279-280
	1 x 4"	280
	2 x 3"	280
	2 x 4"	281
	2 x 5"	281-282
	2 x 6"	282
	2 x 13"	283
	2 x 48"	283
	3 x 7"	283
	3 x 10"	284
	3 x 16"	284
	5 x 18"	285
	6 x 16"	285

33[®] SERIES, GROMMET MOUNT, 1 DIODE, 0.75" ROUND, LED



FEATURES

- Excellent choice for interior applications such as truck cab, walkways, glove boxes, step lights, puddle lights and more
- Creates additional options for improving custom look and theme of vehicle exteriors, mounted on separate switch
- Hardwired lamp design easily retrofitted
- Low profile reduces damage from impact
- LEDs draw less current, allowing more power for other vehicle requirements
- Reduces lighting costs due to physical damage and heat entrapment
- Electronics completely sealed in epoxy to resist corrosion and moisture
- Designed for auxiliary lamp use only
- US Patent #6612728
- Not recommended for marker/clearance purposes

Part Number	Lamp Connector	Plug Side 1	Plug Side 2	Lens Color	Lens Material	Volts	Amps	Kit Includes
33060PR	Hardwired	Hardwired	.180 Bullet	Purple	PC	12	0.13	33260PR light, 33700 grommet
33265B	Hardwired	Hardwired	.180 Bullet	Blue	PC	12	0.04	—
33065B	Hardwired	Hardwired	.180 Bullet	Blue	PC	12	0.06	33265B light, 33700 grommet
33265C	Hardwired	Hardwired	.180 Bullet	Clear	PC	12	0.04	—
33065C	Hardwired	Hardwired	.180 Bullet	Clear	PC	12	0.06	33265C light, 33700 grommet
33265G	Hardwired	Hardwired	.180 Bullet	Green	PC	12	0.04	—
33065G	Hardwired	Hardwired	.180 Bullet	Green	PC	12	0.06	33265G light, 33700 grommet
33265PR	Hardwired	Hardwired	.180 Bullet	Purple	PC	12	0.04	—
33065PR	Hardwired	Hardwired	.180 Bullet	Purple	PC	12	0.06	33265PR light, 33700 grommet
33265R	Hardwired	Hardwired	.180 Bullet	Red	PC	12	0.04	—
33065R	Hardwired	Hardwired	.180 Bullet	Red	PC	12	0.06	33265R light, 33700 grommet
33265Y	Hardwired	Hardwired	.180 Bullet	Yellow	PC	12	0.04	—
33065Y	Hardwired	Hardwired	.180 Bullet	Yellow	PC	12	0.06	33265Y light, 33700 grommet
33095G	Hardwired	Hardwired	.180 Bullet	Green	PC	12	0.06	—

(KIT) (KIT) (KIT) (KIT) (KIT) (KIT) (KIT) (KIT) (KIT) (KIT)

33[®] SERIES, FLANGE MOUNT, 1 DIODE, 0.75" ROUND, LED, KIT

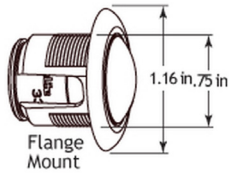

FEATURES

- Excellent choice for interior applications such as truck cab, walkways, glove boxes, step lights, puddle lights and more
- Creates additional options for improving custom look and theme of vehicle exteriors, mounted on separate switch
- Hardwired lamp design easily retrofitted
- Low profile reduces damage from impact
- LEDs draw less current, allowing more power for other vehicle requirements
- Reduces lighting costs due to physical damage and heat entrapment
- Electronics completely sealed in epoxy to resist corrosion and moisture
- Designed for auxiliary lamp use only
- US Patent #6612728
- Not recommended for marker/clearance purposes



LED
33 SERIES

Part Number	Lamp Connector	Plug Side 1	Plug Side 2	Lens Color	Lens Material	Mount Color	Volts	Amps	Kit Includes	
33062PR	Hardwired	Hardwired	.180 Bullet	Purple	PC	Chrome	12	0.13	33260PR light, 33810 flange	(KIT)
33066B	Hardwired	Hardwired	.180 Bullet	Blue	PC	Black	12	0.06	33265B light, 33800 flange	(KIT)
33066C	Hardwired	Hardwired	.180 Bullet	Clear	PC	Black	12	0.06	33265C light, 33800 flange	(KIT)
33066G	Hardwired	Hardwired	.180 Bullet	Green	PC	Black	12	0.06	33265G light, 33800 flange	(KIT)
33066PR	Hardwired	Hardwired	.180 Bullet	Purple	PC	Black	12	0.06	33265PR light, 33800 flange	(KIT)
33066R	Hardwired	Hardwired	.180 Bullet	Red	PC	Black	12	0.06	33265R light, 33800 flange	(KIT)
33066Y	Hardwired	Hardwired	.180 Bullet	Yellow	PC	Black	12	0.06	33265Y light, 33800 flange	(KIT)
33067B	Hardwired	Hardwired	.180 Bullet	Blue	PC	Chrome	12	0.06	33265B light, 33810 flange	(KIT)
33067C	Hardwired	Hardwired	.180 Bullet	Clear	PC	Chrome	12	0.06	33265C light, 33810 flange	(KIT)
33067G	Hardwired	Hardwired	.180 Bullet	Green	PC	Chrome	12	0.06	33265G light, 33810 flange	(KIT)
33067PR	Hardwired	Hardwired	.180 Bullet	Purple	PC	Chrome	12	0.06	33265PR light, 33810 flange	(KIT)
33067R	Hardwired	Hardwired	.180 Bullet	Red	PC	Chrome	12	0.06	33265R light, 33810 flange	(KIT)
33067Y	Hardwired	Hardwired	.180 Bullet	Yellow	PC	Chrome	12	0.06	33265Y light, 33810 flange	(KIT)

SUPER 33, GROMMET MOUNT

1 DIODE, 0.75", LED



FEATURES

- Excellent choice for interior applications such as truck cab, walkways, glove boxes, step lights, puddle lights and more
- Creates additional options for improving custom look and theme of vehicle exteriors, mounted on separate switch
- Hardwired lamp design easily retrofitted
- Low profile reduces damage from impact
- LEDs draw less current, allowing more power for other vehicle requirements
- Reduces lighting costs due to physical damage and heat entrapment
- Electronics completely sealed in epoxy to resist corrosion and moisture
- Designed for auxiliary lamp use only
- US Patent #6612728
- Not recommended for marker/clearance purposes

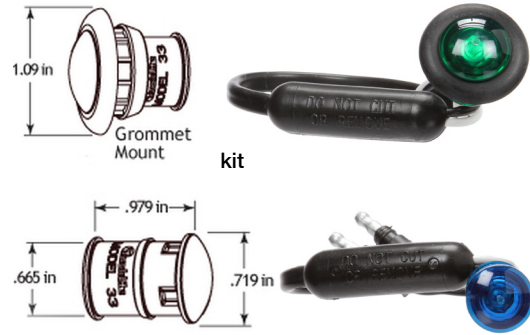

Part Number	Lamp Connector	Plug Side 1	Plug Side 2	Lens Color	Lens Material	Mount Color	Volts	Amps	Kit Includes
33260B	Hardwired	Hardwired	.180 Bullet	Blue	PC	—	12	0.156	—
33060B	Hardwired	Hardwired	.180 Bullet	Blue	PC	Black	12	0.13	33260B light, 33700 grommet (KIT)
33260C	Hardwired	Hardwired	.180 Bullet	Clear	PC	—	12	0.156	—
33060C	Hardwired	Hardwired	.180 Bullet	Clear	PC	Black	12	0.13	33260C light, 33700 grommet (KIT)
33260G	Hardwired	Hardwired	.180 Bullet	Green	PC	—	12	0.156	—
33060G	Hardwired	Hardwired	.180 Bullet	Green	PC	Black	12	0.13	33260G light, 33700 grommet (KIT)
33260R	Hardwired	Hardwired	.180 Bullet	Red	PC	—	12	0.156	—
33060R	Hardwired	Hardwired	.180 Bullet	Red	PC	Black	12	0.13	33260R light, 33700 grommet (KIT)
33260Y	Hardwired	Hardwired	.180 Bullet	Yellow	PC	—	12	0.156	—
33060Y	Hardwired	Hardwired	.180 Bullet	Yellow	PC	Black	12	0.13	33260Y light, 33700 grommet (KIT)
33260PR	Hardwired	Hardwired	.180 Bullet	Purple	PC	—	12	0.156	—



**SUPER 33, LED,
1 DIODE, 0.75", FLANGE MOUNT, KIT**



FEATURES

- Excellent choice for interior applications such as truck cab, walkways, glove boxes, step lights, puddle lights and more
- Creates additional options for improving custom look and theme of vehicle exteriors, mounted on separate switch
- Hardwired lamp design easily retrofitted
- Low profile reduces damage from impact
- LEDs draw less current, allowing more power for other vehicle requirements
- Reduces lighting costs due to physical damage and heat entrapment
- Electronics completely sealed in epoxy to resist corrosion and moisture
- Designed for auxiliary lamp use only
- US Patent #6612728
- Not recommended for marker/clearance purposes

Part Number	Lamp Connector	Plug Side 1	Plug Side 2	Lens Color	Lens Material	Mount Color	Volts	Amps	Kit Includes
33061B	Hardwired	Hardwired	.180 Bullet	Blue	PC	Black	12	0.13	33260B light, 33800 flange (KIT)
33061C	Hardwired	Hardwired	.180 Bullet	Clear	PC	Black	12	0.13	33260C light, 33800 flange (KIT)
33061G	Hardwired	Hardwired	.180 Bullet	Green	PC	Black	12	0.13	33260G light, 33800 flange (KIT)
33061PR	Hardwired	Hardwired	.180 Bullet	Purple	PC	Black	12	0.13	33260PR light, 33800 flange (KIT)
33061R	Hardwired	Hardwired	.180 Bullet	Red	PC	Black	12	0.13	33260R light, 33800 flange (KIT)
33061Y	Hardwired	Hardwired	.180 Bullet	Yellow	PC	Black	12	0.13	33260Y light, 33800 flange (KIT)
33062B	Hardwired	Hardwired	.180 Bullet	Blue	PC	Chrome	12	0.13	33260B light, 33810 flange (KIT)
33062C	Hardwired	Hardwired	.180 Bullet	Clear	PC	Chrome	12	0.13	33260C light, 33810 flange (KIT)
33062G	Hardwired	Hardwired	.180 Bullet	Green	PC	Chrome	12	0.13	33260G light, 33810 flange (KIT)
33062R	Hardwired	Hardwired	.180 Bullet	Red	PC	Chrome	12	0.13	33260R light, 33810 flange (KIT)
33062Y	Hardwired	Hardwired	.180 Bullet	Yellow	PC	Chrome	12	0.13	33260Y light, 33810 flange (KIT)

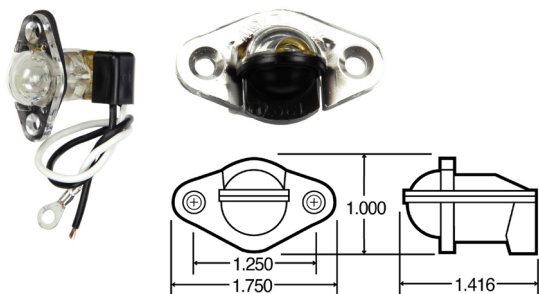

**1 BULB,
1" , ROUND, 2 SCREW, BRACKET MOUNT, KIT**



FEATURES

- Variety of interior and exterior applications
- Sealed polycarbonate construction

Part Number	Lamp Connector	Plug Side 1	Plug Side 2	Lens Color	Lens Material	Mount Color	Volts	Amps	Kit Includes
04115	PL-10	No Plug	No Plug	Clear	PC	Clear	12	0.33	
04116	PL-10	No Plug	No Plug	Clear	PC	Clear	12	0.33	
26001	PL-10	PL-10	Stripped End/ Ring Terminal	Clear	PC	Clear	12	0.33	94854 plug (KIT)

INCANDESCENT

26 SERIES

26 SERIES, 1 BULB, HARDWIRED, BRACKET MOUNT



FEATURES

- Stainless steel housing will not rust or corrode
- Glass lens holds up to extreme temperatures
- Mounts with two # 10 screws on 1.625" centers
- Mounting hole requires 13/16" diameter cutout

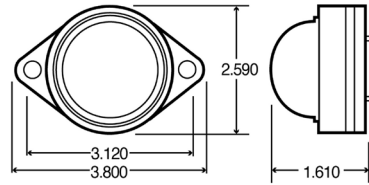

Part Number	Lamp Connector	Plug Side 1	Plug Side 2	Lens Color	Lens Material	Mount Color	Volts	Amps	
26391C	Hardwired	Hardwired	Stripped End	Clear	Glass	Silver	24	1.2	#1156 bulb 32 cp single wire
26392C	Hardwired	Hardwired	Stripped End	Clear	Glass	Silver	24	1.2	#1076 bulb 32 cp two wire w/ground wire
26393C	Hardwired	Hardwired	Stripped End	Clear	Glass	Silver	12	1.43	#1141 bulb 21 cp single wire
26394C	Hardwired	Hardwired	Stripped End	Clear	Glass	Silver	12	1.43	#1142 bulb 21 cp two wire w/ground wire

INCANDESCENT

20 SERIES

20 SERIES, 1 BULB, HARDWIRED, 2 SCREW BRACKET MOUNT, 2" ROUND



FEATURES

- Features beehive profile lens which produces maximum 90-degree edge lighting
- Snap-in lens for quick and easy replacement
- Utility lamp, #20308 not intended for dome lamp use

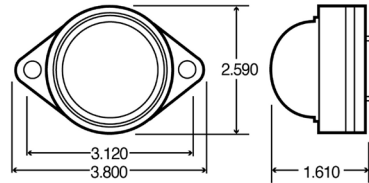

Part Number	Lamp Connector	Plug Side 1	Plug Side 2	Lens Color	Lens Material	Mount Color	Volts	Amps
20302	Hardwired	Hardwired	Stripped End	Clear	PC	Silver	12	0.97
20308	Hardwired	Hardwired	.180 Bullet	Clear	PC	Silver	12	2.1

INCANDESCENT

30 SERIES

30[®] SERIES, SEALED, 2 SCREW BRACKET MOUNT, 2" ROUND



FEATURES

- High-impact polycarbonate construction
- Lens and housing are sonically sealed
- 15,000 hour rated 12V bulb life

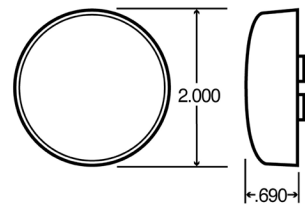

Part Number	Lamp Connector	Plug Side 1	Plug Side 2	Lens Color	Lens Material	Mount Color	Volts	Amps
30200C	PL-10	No Plug	No Plug	Clear	PC	Grey	12	0.33
30206C	PL-10	No Plug	No Plug	Clear	PC	—	24	0.17



**10[®] SERIES, SEALED,
2.5", GROMMET MOUNT**



Part Number	Lamp Connector	Lens Color	Lens Material	Volts	Amps
10202C	PL-10	Clear	PC	12	0.33
10204C	PL-10	Clear	PC	24	0.17

FEATURES

- Lens and housing are sonically sealed
- High-impact polycarbonate construction
- 15,000 hour rated bulb life

INCANDESCENT

10 SERIES



**SUPER 10[®] SERIES, SEALED,
2.5", GROMMET MOUNT**



Part Number	Lamp Connector	Lens Color	Lens Material	Volts	Amps
10209C	PL-10	Clear	PC	12	0.33

FEATURES

- Lens and housing are sonically sealed
- High-impact polycarbonate construction
- 15,000 hour rated bulb life
- Replaces Signal-Stat 1010W

INCANDESCENT

10 SERIES



**44[®] SERIES, GROMMET MOUNT,
6 DIODE, 4" ROUND, LED, KIT**



Part Number	Lamp Connector	Plug Side 1	Plug Side 2	Lens Color	Lens Material	Mount Color	Volts	Amps	Kit Includes
44057C	Hardwired	Hardwired	.180 Bullet	Clear	PC	Black	12	0.54	44308C light, 40700 grommet 

FEATURES

- Virtually impervious to shock and vibration

LED

44 SERIES

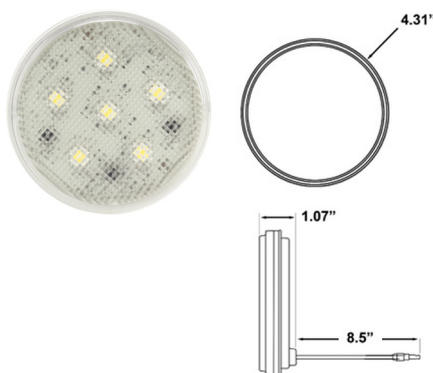

**SUPER 44[®], GROMMET MOUNT,
6 DIODE, 4" ROUND, LED**



Part Number	Lamp Connector	Plug Side 1	Plug Side 2	Lens Color	Lens Material	Volts	Amps
44308C	Hardwired	Hardwired	.180 Bullet	Clear	PC	12	0.54

FEATURES

- Low-profile lamp, approximately 1" deep for where space is at a premium
- Features robust and cost-effective design
- Virtually impervious to shock and vibration
- Epoxy-encapsulated electronics protect the lamp from damage caused by chemicals and moisture
- Designed to operate in extremely cold temperatures
- Broad light pattern with approximately 360 lumens of light output
- U.S. Registered TM #3483147

LED

SUPER 33

LED
SUPER 33

SUPER 44[®], FLANGE MOUNT, 6 DIODE, 4" ROUND, LED

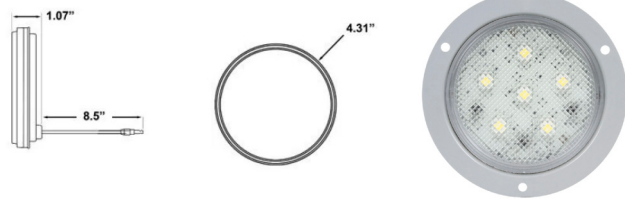

FEATURES

- Low profile lamp, approximately 1" deep for where space is at a premium
- Low profile back due to modified plug connection
- Same 6 diode pattern used in Truck-Lite Stop/Turn/Tail, Back-Up and Strobe withoverride lamps
- Features robust and cost effective design
- Virtually impervious to shock and vibration
- Epoxy-encapsulated electronics protect the lamp from damage caused by chemicals and moisture
- Designed to operate in extremely cold temperatures
- Broad light pattern with approximately 360 lumens of light output
- US Registered TM #3483147

Part Number	Lamp Connector	Plug Side 1	Plug Side 2	Lens Color	Lens Material	Mount Color	Volts	Amps	Push Button Switch Y/N
44339C	Hardwired	Hardwired	.180 Bullet	Clear	PC	Gray	12	0.54	No
44352C	Hardwired	Hardwired	.180 Bullet	Clear	PC	White	12	0.54	No

LED
44 SERIES

SUPER 44[®], SURFACE MOUNT, 6 DIODE, 4" ROUND, LED

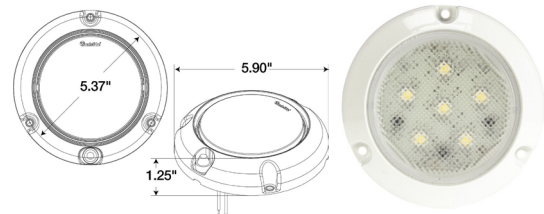

Pillow optic shown

FEATURES

- Surface-mount design eliminates the need for large hole cutouts in trailer ceiling
- White housing design blends well with refrigerated trailer interiors
- Available with integrated on/off switch as well as externally controlled version
- Lens design recesses lens into housing to prevent damage from impact
- Not affected by cold temperatures, providing flicker-free lighting with a faster start-up time
- Ideal for refrigerated vehicles or those operating in cold weather
- Solid-state LED design is impervious to damage from shock and vibration
- Retrofit or replacement is quick and easy
- LED are fully encapsulated in epoxy to prevent damage caused by moisture and corrosives
- Recommend 3 #10 machine screws for mounting, with torque of 15-18 in-lbs

Part Number	Lamp Connector	Plug Side 1	Plug Side 2	Lens Color	Lens Material	Mount Color	Volts	Amps	Push Button Switch Y/N
44439C	Hardwired	Hardwired	Stripped End	Clear	PC	White	12	0.54	No
44438C	Hardwired	Hardwired	Stripped End	Clear	PC	White	12	0.54	Yes

LED
44 SERIES

44[®] SERIES, GROMMET MOUNT, 54 DIODE, 4" ROUND, LED

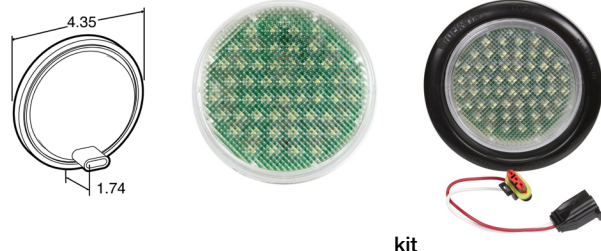

kit

FEATURES

- Popular in trailer and body applications
- 85% reduction of load on electrical system allows more power for other vehicle requirements
- Virtually impervious to shock and vibration

Part Number	Lamp Connector	Plug Side 1	Plug Side 2	Lens Color	Lens Material	Volts	Amps	Kit Includes
44042C	Fit 'N Forget S.S.	Fit 'N Forget S.S.	Female PL-2	Clear	PC	12	0.11	44307C light, 40700 grommet, 94789 plug
44207C	Fit 'N Forget S.S.	No Plug	No Plug	Clear	PC	12	0.11	—





44[®] SERIES, FLANGE MOUNT, 54 DIODE, 4" ROUND, LED

FEATURES

- Popular in trailer and body applications
- 85% reduction of load on electrical system allows more power for other vehicle requirements
- Virtually impervious to shock and vibration



Part Number	Lamp Connector	Plug Side 1	Plug Side 2	Lens Color	Lens Material	Mount Color	Volts	Amps
44237C	Fit 'N Forget S.S.	No Plug	No Plug	Clear	PC	Gray	12	0.11

LED
44 SERIES



40203



40003 - kit



40211

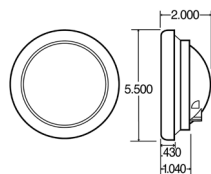

40[®] SERIES, SEALED GROMMET MOUNT, 4" ROUND

FEATURES

- Sealed polycarbonate lens and housing
- Grommet kit features flush mounting in a 4 1/2" hole
- Upgrade to LED Lighting Systems using Truck-Lite's Super 44 Series products



Part Number	Lamp Connector	Plug Side 1	Plug Side 2	Lens Color	Lens Material	Volts	Amps	Kit Includes	
40203	PL-2	—	—	Clear	Diffused Lens	PC	12	1.44	—
40003	PL-2	PL-2	Stripped End/ Ring Terminal	Clear	Diffused Lens	PC	12	1.44	40203 model 40 dome light, 40700 grommet, 94922 plug
40211	PL-2	—	—	Clear	Clear Back	PC	12	1.44	—
40227	PL-2	—	—	Clear	Diffused Lens	PC	12	1.44	—

(KIT)

INCANDESCENT
40 SERIES

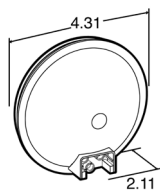

40[®] SERIES, SEALED GROMMET MOUNT, 4" ROUND

FEATURES

- Used on new Wabash trailers
- Uniquely designed shock mount extends lamp life
- For auxiliary use only
- Specially designed lens allows lamp to angle light away from trailer rather than straight back
- Output light up to 10' on sides at a 45 degree angle
- Illuminates area seen by driver through side mirrors



Part Number	Lamp Connector	Lens Color	Lens Material	Volts	Amps
40207	PL-2	Clear	PC	12	2.1

INCANDESCENT
40 SERIES

40[®] SERIES, SEALED, FLANGE MOUNT, 4" ROUND



FEATURES

- Polycarbonate lens and housing are sonically sealed
- Bulb is shock-mounted for extended life
- Upgrade to LED lighting systems using Truck-Lite's Super 44 Series

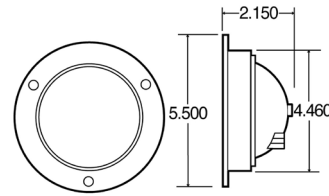

Part Number	Lamp Connector	Plug Side 1	Plug Side 2	Lens Color	Lens Material	Mount Color	Volts	Amps	Kit Includes
40223	PL-2	No Plug	No Plug	Clear	PC	Gray	12	1.44	—
40023	PL-2	PL-2	Stripped End/Ring Terminal	Clear	PC	Gray	12	1.44	40223 light, 94992 grommet



SINGLE BULB RECEPTACLE, FLANGE MOUNT, 4" ROUND



FEATURES

- Designed to illuminate area between truck and trailer
- Features chrome-plated die-cast housing
- Mounts to flat body surface with three screws
- Not intended for use as a back-up lamp
- Replacement Lens #99080C

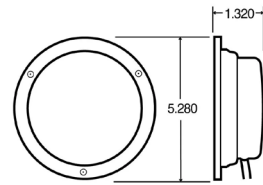

Part Number	Lamp Connector	Plug Side 1	Plug Side 2	Lens Color	Lens Material	Mount Color	Volts	Amps
80423C	Hardwired	Hardwired	Stripped End	Clear	AC	Chrome	12	2.25

80 SERIES, SINGLE BULB RECEPTACLE, FLANGE MOUNT, 5" ROUND



FEATURES

- Available with push style on/off switch
- Choice of chrome-plated or silver epoxy-powder coated steel housing
- Uses #1156 bulb

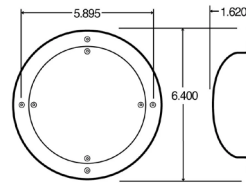

Part Number	Lamp Connector	Plug Side 1	Plug Side 2	Lens Color	Lens Material	Mount Color	Volts	Amps
80350	Hardwired	Hardwired	Stripped End	Clear	PC	Chrome	12	2.1
80351	Hardwired	Hardwired	Blunt Cut	Clear	PC	Chrome	12	2.1
80352	Hardwired	Hardwired	Blunt Cut	Clear	PC	Chrome	12	2.1
80353	Hardwired	Hardwired	Blunt Cut	Clear	PC	Chrome	12	2.1

80 SERIES, SINGLE BULB RECEPTACLE, FLANGE MOUNT, 5" ROUND



FEATURES

- Designed for interior use only
- Features Snap-On lens for ease of installation

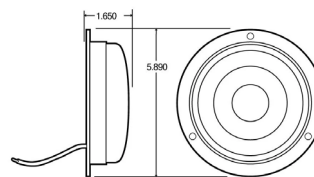

Part Number	Lamp Connector	Plug Side 1	Plug Side 2	Lens Color	Lens Material	Mount Color	Volts	Amps
80427	Hardwired	Hardwired	Stripped End	Clear	PC	White	12	1.43

INCANDESCENT

40 SERIES

INCANDESCENT

1 BULB

INCANDESCENT

80 SERIES

INCANDESCENT

1 BULB

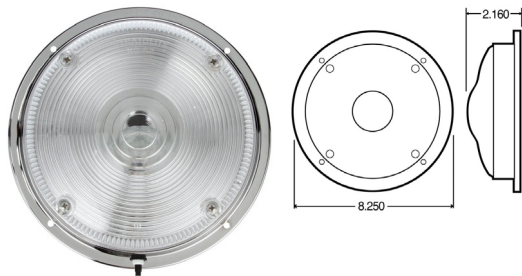

**80 SERIES,
SINGLE BULB RECEPTACLE,
FLANGE MOUNT, 7" ROUND,**

FEATURES

- Available with push style on/off switch
- Choice of chrome-plated or epoxy-powder coated steel housing
- Lens attaches to housing with four screws
- Uses flanged mounting to mount to a flat surface



Part Number	Lamp Connector	Plug Side 1	Plug Side 2	Lens Color	Lens Material	Mount Color	Volts	Amps
80354	Hardwired	Hardwired	Stripped End	Clear	AC	Chrome	12	2.1
80355	Hardwired	Hardwired	Stripped End	Clear	AC	Chrome	12	2.1
80356	Hardwired	Hardwired	Stripped End	Clear	AC	Silver	12	2.1
80357	Hardwired	Hardwired	Stripped End	Clear	AC	Silver	12	2.1



36204C



36215C

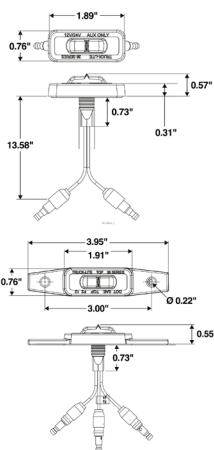

**36 SERIES, LED,
ADHESIVE MOUNT,
1" X 2", RECTANGULAR**

FEATURES

- Provides robust LED white lighting solution that does not require mounting brackets or installation screws
- Light adheres directly to mounting surface with heavy-duty adhesive backing, with an easy-to-install, peel-off liner
- Small profile makes it ideal for interior, tool box, storage, under cabinet, and other small spaces
- Perfect for rock lights in off-road application
- Electronics are completely sealed in epoxy to resist damage caused by moisture, corrosion, shock and vibration



Part Number	Lamp Connector	Plug Side 2	Exit Wire	Lens Color	Lens Material	Mount Color	Volts	Amps
36204C	Hardwired	.180 Bullet	Rear	Clear	PC	Black	12 24	0.5
36205C	Hardwired	.180 Bullet	Rear	Clear	PC	Black	12 24	0.5
36214C	Hardwired	.180 Bullet	Side	Clear	PC	Black	12 24	0.5
36215C	Hardwired	.180 Bullet	Side	Clear	PC	Black	12 24	0.5

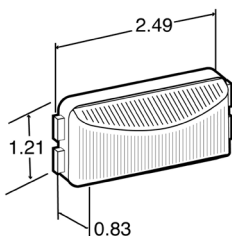

**15[®] SERIES, SEALED
1" X 2", BRACKET MOUNT, RECTANGULAR**

FEATURES

- High-impact polycarbonate sonically sealed lens and housing
- Features 15,000 hour long-life bulb
- Replaces Signal-Stat 1500W



Part Number	Lamp Connector	Lens Color	Lens Material	Volts	Amps
15200C	PL-10	Clear	PC	12	0.33

INCANDESCENT

80 SERIES

LED

SIGNAL-STAT

INCANDESCENT

15 SERIES

INCANDESCENT

SIGNAL-STAT, BRACKET MOUNT, BULB REPLACEABLE LAMP, 1" X 2", RECTANGULAR



FEATURES

- Focused light output
- Hooded guard to stop glare
- Separate ground wire
- Uses #193 2 cp bulb

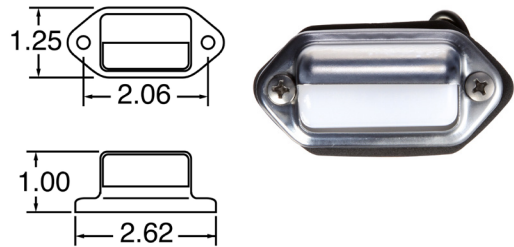

Part Number	Lamp Connector	Plug Side 1	Plug Side 2	Lens Color	Lens Material	Mount Color	Volts	Amps
434WD	Hardwired	Hardwired	Stripped End	Clear	Acrylic	Chrome	12	0.27

SIGNAL-STAT

INCAN.

SIGNAL-STAT, BRACKET MOUNT, BULB REPLACEABLE LAMP, 1" X 2", 2 BULB, RECTANGULAR



FEATURES

- Snap-in lens for easy bulb replacement
- Vulcanized rubber housing with aluminum base
- Uses #1895 2 cp bulb

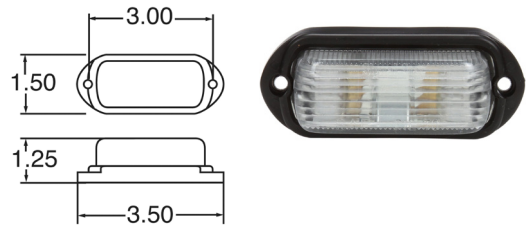

Part Number	Lamp Connector	Plug Side 1	Plug Side 2	Lens Color	Lens Material	Mount Color	Volts	Amps
1506W	Hardwired	Hardwired	Stripped End	Clear	Acrylic	Black	12	0.27

SIGNAL-STAT

INCAN.

19[®] SERIES, SEALED, 1" X 4", BRACKET MOUNT, 2 BULB, RECTANGULAR



FEATURES

- High-impact polycarbonate sonically sealed lens and housing
- Features 15,000 hour long-life bulb

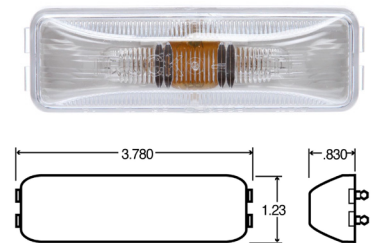

Part Number	Lamp Connector	Lens Color	Lens Material	Volts	Amps
19200C	19 Series Male Pin	Clear	PC	12	0.33

19 SERIES

INCANDESCENT

12[®] SERIES, BRACKET MOUNT, 2" X 3", 1 BULB, RECTANGULAR



FEATURES

- Standard replacement for UPS
- Sonically sealed lens and housing
- 15,000 rated 12V bulb life
- Optional mounting gasket to improve seal between lamp and body

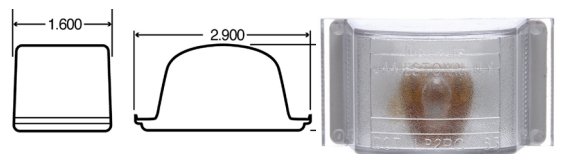

Part Number	Lamp Connector	Lens Color	Lens Material	Volts	Amps
12200C	PL-10	Clear	PC	12	0.33

12 SERIES

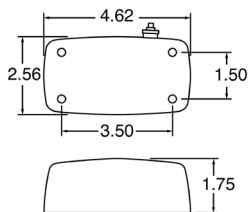

**SIGNAL-STAT, 4 SCREW
BRACKET MOUNT,
2" X 4", BULB REPLACEABLE**

FEATURES

- Use for dome or utility lamp
- Raised lens for maximum output
- Surface mount for easy installation



Part Number	Lamp Connector	Plug Side 1	Plug Side 2	Lens Color	Lens Material	Mount Color	Volts	Amps
549SWD	Hardwired	Hardwired	Stripped End	Clear	PC	Silver	12	2.1

INCANDESCENT

SIGNAL-STAT

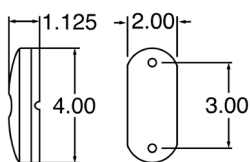

**SIGNAL-STAT, BULB REPLACEABLE,
2" X 4", FLANGE MOUNT**



FEATURES

- 15,000-hour bulbs
- Corrosion-proof Permastat housing
- Snap-on lens for easy bulb replacement
- Uses two #194 bulbs



Part Number	Lamp Connector	Plug Side 1	Plug Side 2	Lens Color	Lens Material	Volts	Amps
1211W	Hardwired	Hardwired	Blunt Cut	Clear	Acrylic	12	0.27

INCANDESCENT

SIGNAL-STAT

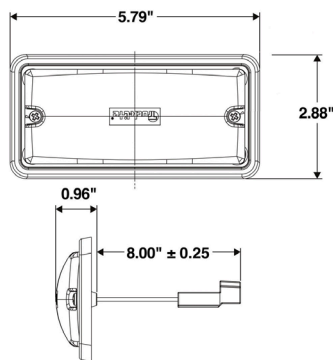

**80 SERIES, LED,
4 SCREW BRACKET MOUNT,
2" X 5", LED, 6 DIODE**

FEATURES

- Surpasses 2,000 hours of incandescent bulbs by nearly 50x
- 60% lower power consumption than incandescent lamps, allowing more power for other vehicle requirements
- Electronics fully sealed in epoxy, to resist against corrosion & moisture



Part Number	Lamp Connector	Plug Side 1	Plug Side 2	Lens Color	Lens Material	Mount Color	Volts	Amps
80163C	Hardwired	Hardwired	Packard Connector	Clear	PC	Black	12	0.38

LED

80 SERIES

LED

80 SERIES

80 SERIES, LED, SCREW MOUNT INTERIOR, 2" X 5", LED, 6 DIODE



FEATURES

- U.S. Patent #7244058
- Die-cast aluminum housing
- White powder-coat finish
- Polycarbonate lens
- 10 White, 1W LEDs
- Lower profile than competitor lamps
- Nearly flush-mount, only .1" protrusion
- Not affected by cold temperatures
- LEDs provide whiter, brighter light
- Retrofit or replacement is quick and easy
- Flicker-free lighting in all temperatures

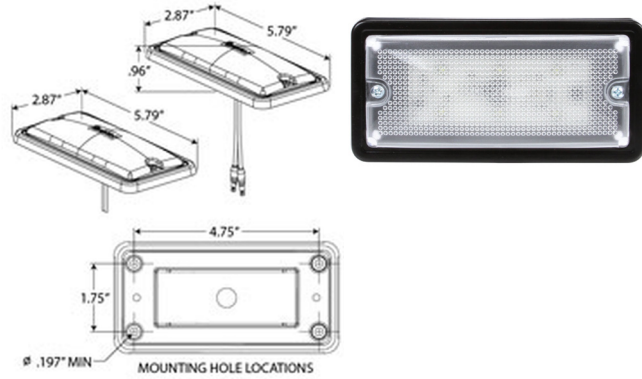

Part Number	Lamp Connector	Plug Side 1	Plug Side 2	Lens Color	Lens Material	Mount Color	Volts	Amps
80162C	Hardwired	Hardwired	Stripped End	Clear	PC	Black	12	0.38
80164C	Hardwired	Hardwired	.180 Bullet	Clear	PC	Black	12	0.38

INCANDESCENT

SIGNAL-STAT

SIGNAL-STAT, BULB REPLACEABLE, 2" X 5", 2 SCREW BRACKET MOUNT



FEATURES

- Twist-off lens hood for easy bulb replacement
- Lights up instrument panel and compartments
- Surface mounts on 2" centers
- Grounds through mounting screws
- Polycarbonate housing will not rust

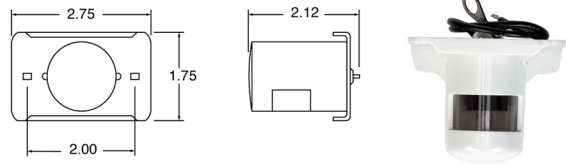

Part Number	Lamp Connector	Plug Side 1	Plug Side 2	Lens Color	Lens Material	Mount Color	Volts	Amps
433WD	Hardwired	Hardwired	Stripped End/ Ring Terminal	Clear	Acrylic	White	12	0.35

INCANDESCENT

SIGNAL-STAT

SIGNAL-STAT, BULB REPLACEABLE, 2" X 6", 2 SCREW BRACKET MOUNT



FEATURES

- Navistar replacement
- Use for dome or utility lamp
- Surface mount for easy installation

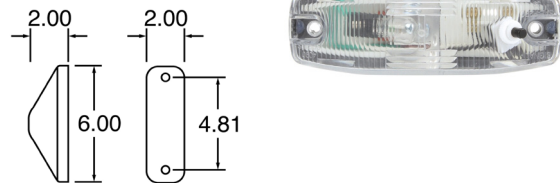

Part Number	Lamp Connector	Plug Side 1	Plug Side 2	Lens Color	Lens Material	Mount Color	Volts	Amps
4094SW	PL-2	Female PL-2	Packard Connector	Clear	PC	White	12	1



80 SERIES, FLANGE MOUNT INTERIOR, 2" X 13", LED, 10 DIODE

FEATURES

- U.S. Patent #7244058
- Die cast aluminum housing
- White Powder coat finish
- 10 White 1W LEDs
- Lower profile than competitive lamps
- Nearly flush mount, only .1" protrusion
- Not affected by cold temperatures
- LEDs provide whiter, brighter light
- Retrofit or replacement is quick and easy
- Flicker-free lighting in all temperatures



Part Number	Lamp Connector	Plug Side 1	Plug Side 2	Lens Color	Lens Material	Mount Color	Volts	Amps
80251C	Hardwired	Hardwired	Stripped End	Clear	PC	Black	12	0.38

LED
80 SERIES



84 SERIES, LED, 12 DIODE, 2" X 48", BRACKET MOUNT INTERIOR

FEATURES

- LED light source provides more even truck cargo light
- Aluminum housing won't rust
- Less susceptible to shock and vibration
- Reduces shadowed areas and increases visibility
- Can be mounted almost anywhere
- LEDs draw less current, creating less heat
- Designed for interior use only



Part Number	Lamp Connector	Plug Side 1	Plug Side 2	Lens Color	Lens Material	Mount Color	Volts	Amps	
84200C	Hardwired	Hardwired	.180 Bullet	Clear	PC	White	12	1.27	4 in corner

LED
84 SERIES

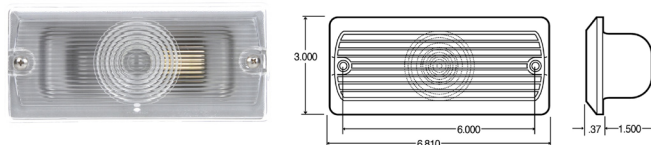

BULB REPLACEABLE, 2 SCREW BRACKET MOUNT, 3" X 7", RECTANGULAR

FEATURES

- Flush mounts on two screws at 6.0" centers
- Requires a 2" x 5-1/4" hole
- Grounds through mounting screws
- Functions as an interior dome, a compartment or utility lamp
- Heavy-duty steel and acrylic construction



Part Number	Lamp Connector	Plug Side 1	Plug Side 2	Lens Color	Lens Material	Volts	Amps
81350	Hardwired	Hardwired	Stripped End	Clear	Acrylic	12	1.04

INCANDESCENT
1 BULB

SIGNAL-STAT, LED, 4 DIODE, 3" X 10", 2 SCREW BRACKET MOUNT



FEATURES

- Ideal for flood, cargo, step, locker and overhead lighting
- Can be fitted in semi-trailer, trailer, box van, mini-bus/coach, emergency services, utilities, recovery and load-handling vehicles
- Utilizes an extremely reliable slimline design and combines both dual-voltage and dual-polarity functions
- Instant switch on with easy surface mount and offset optical design making it easy to position in any orientation to direct light to the desired area
- Low-profile, waterproof to IP67 and reliable to a temperature of minus 40° C
- ECE-approved LED interior lamp to ECE 95/54, EEC 2000/2, ECE Reg. 10

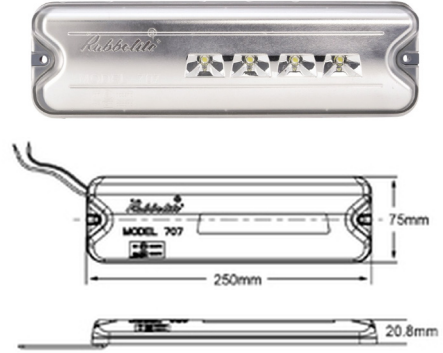

Part Number	Lamp Connector	Plug Side 1	Plug Side 2	Lens Color	Lens Material	Mount Color	Volts	Amps
8013	Hardwired	Hardwired	Blunt Cut	Clear	PC	Gray	12 24	1.15

80 SERIES, BRACKET MOUNT, DOME LIGHT 8 SCREW, 10 DIODE, 3" X 16", LED



FEATURES - 80255C ONLY

- Robust LED dome lamp w/motion sensor located in center of lamp to power lamp on
- Motion sensor determined by changes in heat and stays on through 5 minutes of inactivity
- Recognizes movement up to 10 feet away from lamp surface

FEATURES - BOTH

- Nearly flush mount design, with only 1 inch protrusion to allow more room in vehicle body
- Not affected by cold temperatures, providing flicker-free lighting with a faster start-up time
- Ideal for refrigerated vehicles or those operating in cold weather
- LEDs provide whiter, brighter light rated at 1,000 lumens, providing clearer, improved visibility
- Solid-state LED design is impervious to damage from shock and vibration
- Retrofit or replacement is quick and easy, with a standard 16x4 cut-out necessary for installation
- LEDs are fully encapsulated in epoxy to prevent damage caused by moisture and corrosives

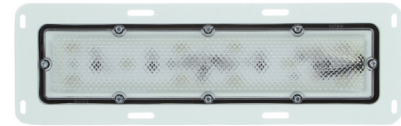

80253C

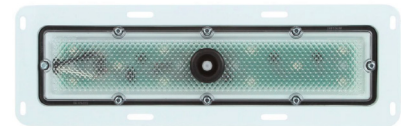

80255C

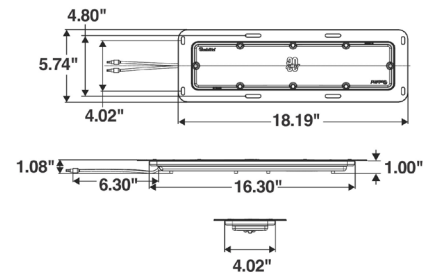

Part Number	Lamp Connector	Plug Side 1	Plug Side 2	Lens Color	Lens Material	Mount Color	Volts	Amps	Motion Sensor
80253C	Hardwired	Hardwired	.180 Bullet	Clear	PC	White	12	2	No
80255C	Hardwired	Hardwired	.180 Bullet	Clear	PC	White	12	2	Yes

LED

SIGNAL-STAT

LED

80 SERIES



**FLUORESCENT, 2 BULB,
5" X 18", 2 SCREW BRACKET MOUNT**

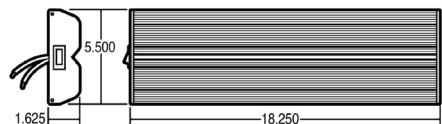

FEATURES

- High-impact snap-on polycarbonate lens
- Metal housing is white epoxy powder-coated
- Installation is easy with integrated 2-pin Packard connector
- Lamp plug connector mates with Packard connector #12129081
- Upgrade to LED lighting systems using Truck-Lite's 80 Series



Part Number	Lamp Connector	Plug Side 1	Plug Side 2	Lens Color	Lens Material	Mount Color	Volts	Amps
80444	Hardwired	Hardwired	Stripped End	Clear	Acrylic	Silver	12	2.2

FLUORESCENT

2 SCREW



**80 SERIES, FLANGE MOUNT INTERIOR,
6 DIODE, 6" X 16", LED**

FEATURES

- Patent Pending
- Not affected by cold temperatures
- LEDs provide whiter, brighter light
- Rugged aluminum housing and polycarbonate lens
- Electronics sealed in a conformal coating
- Weighs only 2 pounds
- Exclusive OmniVolt technology
- Standard size makes retrofit or replacement quick and easy



Part Number	Lamp Connector	Plug Side 1	Plug Side 2	Lens Color	Lens Material	Mount Color	Volts	Amps
80250C	Hardwired	Hardwired	Stripped End	Clear	PC	White	12 24	1.15

LED

80 SERIES

LIGHTING REPLACEMENT PARTS

REPLACEMENT LENSES

Pages 288-296

Shape	Page
Round	288-290
Oval	291-292
Rectangular	292-295
Square	296
Triangle	296
Beehive	296

REPLACEMENT BULBS

Pages 298-300

Series	Page
Halogen	298-299
Incandescent	300
Strobe Tube	300

ROTATOR ASSEMBLY

Page 301

STROBE MOUNTING MAGNETS

Page 302

Series	Page
Steel	302
Rubber	302

STROBE POWER SUPPLYS

Page 303

FLASHER MODULES

Pages 304-311

Series	Page
Electro-Mechanical	304-306
Solid-State	307-309
Thermal	309
Connectors	310
DRL Systems	310

RELAYS

Pages 312-313

Series	Page
5 Blade Terminal	312
4 Blade Terminal	313

**ROUND, 1",
SNAP-FIT**

Part Number	Lens Color	Compatible Parts
7332	Red	5040, 5040, 5040



**ROUND, 2",
SNAP-FIT**

Part Number	Lens Color	Compatible Parts
99005C	Clear	Dome & Utility (20302, 20308)
99005R	Red	20 Series Lamps
99005Y	Yellow	Signal Lighting Lamps (20301Y, 20304Y, 20316Y), Signal-Stat (9354 Series)
99034R	Red	Replacement for Grote, snap-fit
99034Y	Yellow	Replacement for Grote, snap-fit
99035R	Red	26309R, 26318R
99035Y	Yellow	26309Y, 26318Y

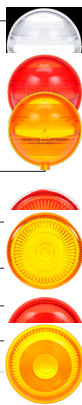

**ROUND, 2",
2-SCREW**

Part Number	Lens Color	Compatible Parts
99107Y	Yellow	Marker Lamps Side Turn Signal (26390Y)



**ROUND, 3",
SNAP-FIT**

Part Number	Lens Color	Compatible Parts
99104R	Red Clear	
99105R	Red	
99001R	Red	
99001Y	Yellow	
99044R	Red	Betts Lamps
99044Y	Yellow	Betts Lamps
8909	Red	Stop/Turn/Tail Lamp (2110, 2112)
8943	Red	Cab Marker (1319)
8943A	Yellow	Cab Marker (1319A)
8943W	Clear	Cab Marker (1319)
8945	Red	M/C Lamps (1115, 1116)
8945A	Yellow	M/C Lamps (1115, 1116)
9076W	Clear	Back-up Lamps (92WD)
9081	Red	Cab Marker (GM 2004543)
9081A	Yellow	Cab Marker (GM 799386)



**ROUND, 3",
THREADED FIT**

Part Number	Lens Color	Compatible Parts
9719A	Yellow	Strobes (92560, 92563)



**ROUND, 4",
SNAP-FIT**

Part Number	Lens Color	Compatible Parts
99120B	Blue	Par 36 Sealed Beams (80373)
99120C	Clear	Par 36 Sealed Beams (80373)
99120R	Red	Par 36 Sealed Beams (80373)
99147Y	Yellow	Strobes (92504Y, 92505Y, 94Y, 99Y, 92534Y)
99007C	Clear	Most 4" Lamps
99007R	Red	Front, Rear Lighting (80302R), Most 4" Lamps
99007Y	Yellow	Front, Rear Lighting (80302Y), Most 4" Lamps
99009R	Red	Pedestal Lamps (70330R, 70300)
99009Y	Yellow	Pedestal Lamps (70330Y, 70300)
99090R	Red	Pedestal Lamps (70310R, 70311, 70330R, 80329R)
99090Y	Yellow	Pedestal Lamps (70310R, 70311, 70330Y, 80329R)
9029	Red	Snap Ring Lamps
9029A	Yellow	Snap Ring Lamps
9029B	Blue	Snap Ring Lamps
8936	Red	Pedestal Lamps (677WK, 3753, 3754, 3755, 3756, 3850, 3853)
8936A	Yellow	Pedestal Lamps (677WK, 3753, 3754, 3755, 3756, 3850, 3853AA)
8936B	Blue	Pedestal Lamps (677WK, 3753, 3754, 3755, 3756, 3850, 3853)
9041	Red	3751, 3752, 3851, Front, Rear Lighting (540D, 541)
9041A	Yellow	3751, 3752, 3851, Front, Rear Lighting (540 Series)
9341	Red	Pedestal Lamps (3760, 3763, 3860, 3861, 3862, 3863, 3762)
9341A	Yellow	Pedestal Lamps (3760, 3763, 3860, 3861, 3862, 3863, 3762)
9341B	Blue	Pedestal Lamps (3760, 3763, 3860, 3861, 3862, 3863, 3762)
9341G	Green	Pedestal Lamps (3760, 3763, 3860, 3861, 3862, 3863, 3762)
9341W	Clear	Pedestal Lamps (3760, 3763, 3860, 3861, 3862, 3863, 3762)



**ROUND, 4",
2-SCREW**

Part Number	Lens Color	Compatible Parts
99066Y	Yellow	M/C Lamps (26760Y)
99083R	Red	80461R, 80462R, 80463R, Pathfinder
8974	Red	2201, 2203, 2204



**ROUND, 4",
3-SCREW**

Part Number	Lens Color	Compatible Parts
9016	Red	Front, Rear Lighting (3612, 3616), Pedestal Lamps (3802, 3806, 3812, 2801, 2803, 3801, 3810, 3805Y115, 2701, 3701, 2702)
9016B	Blue	Pedestal Lamps
9016A	Yellow	Pedestal Lamps (3802, 3806, 3812, 2801, 2803, 3801, 3810, 2701A, 2702A)
9016W	Clear	Front, Rear Lighting (3613W), License Lamps (3693W, 3691W)
9016GA	Green	Pedestal Lamps
9021	Red	Front, Rear Lighting (3612, 3616), Pedestal Lamps (3802, 3806, 3812, 2801, 2803, 3801, 3810, 3805Y115, 2701, 3701)
9021A	Yellow	Pedestal Lamps (3802, 3806, 3812, 2801, 2803, 3801, 3810, 2701A)
9021W	Clear	Front, Rear Lighting (3613W), License Lamps (3693W C, 3691W C)



**ROUND, 4",
THREADED FIT**

Part Number	Lens Color	Compatible Parts
9720A	Yellow	Strobes (300A L, 301A L, 307AP)
9720	Red	Strobes (307R)
9720B	Blue	Strobes (307B)
9720W	Clear	Beacons, LED Strobes



**ROUND, 5",
SNAP-FIT**

Part Number	Lens Color	Compatible Parts
99101R	Red	Betts Lamps
99008C	Clear	License Lamps (80342, 80344, 80345) Most 4" Lamps
99008R	Red	Front, Rear Lighting (80334R, 80339R, 81301R) Most 4" Lamps
99008Y	Yellow	Front, Rear Lighting (81300Y) Most 4" Lamps
99010C	Clear	Back-up Lamps (40306)
99010R	Red	Front, Rear Lighting (40302R, 40318R)
99010Y	Yellow	Front, Rear Lighting (40302Y, 40318Y)
8919	Red	Signal Lighting Lamps (4710)
8919A	Yellow	Signal Lighting Lamps (4710)
8935W	Clear	Universal Dome (9380W)



**ROUND, 5",
2-SCREW**

Part Number	Lens Color	Compatible Parts
99176C	Clear	Dome, Utility (80423C Hook-up Lamps)
99150C	Clear	Light Bars (92520Y, 92521Y, 92522Y, 92523Y, 92524Y, 92525Y)



**ROUND, 5",
THREADED FIT**

Part Number	Lens Color	Compatible Parts
99080C	Clear	Dome & Utility (80350, 80351, 80352, 80353)
99082C	Clear	Dome & Utility (80350, 80352)
99082R	Red	Dome & Utility (80350, 80351)



**ROUND, 6",
SNAP-FIT**

Part Number	Lens Color	Compatible Parts
99108Y	Yellow	Strobe (92351Y, 92531Y, 92530Y)
40270C	Clear	0.05" Aluminum Sheets, Dome & Utility Lamps
40271C	Clear	0.31" Composite Panels, Dome & Utility Lamps
40275C	Clear	0.25" Composite Panels, Dome & Utility Lamps
9723A	Yellow	Beacons (6822A, 6823A)



**ROUND, 6",
2-SCREW**

Part Number	Lens Color	Compatible Parts
9710W	Clear	Strobes (6601, 6611, 6801, 6811)



**ROUND, 6",
3-SCREW**

Part Number	Lens Color	Compatible Parts
99145Y	Yellow	Strobes (92500Y, 92506Y, 92513Y, 92502Y, 92508Y, 92515Y, 92501Y, 92507Y, 92514Y)



**ROUND, 6",
THREADED FIT**

Part Number	Lens Color	Compatible Parts
99220Y	Yellow	Strobes (92572Y, 6811A, 6811MA, 6601A, 6601MA, 92860Y LED, 92861Y LED)
99220W	Clear	Strobes (92572Y, 6811A, 6811MA, 6601A, 6601MA, 92860Y LED, 92861Y LED)
99220B	Blue	Strobes & Beacons (6811B, 6601B)
99220R	Red	Strobes & Beacons (6811R, 6601R)
99221Y	Yellow	Strobes (92862Y LED, 92863Y LED, 92573Y, 6600A, 6600MA, 6810A, 6810MA)
99221R	Red	Strobes & Beacons (6600R, 6810R)
99221W	Clear	Strobes & Beacons (6600W, 6810W)

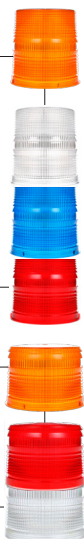

**ROUND, 7",
4-SCREW**

Part Number	Lens Color	Compatible Parts
99167Y	Yellow	Bus Lamps (90325Y, 6505)
99168C	Clear	Bus Lamps (6504, 90327R/Y), Signal-Stat (6503)
99168R	Red	Bus Lamps (90327R, 6503, 6504)
99168Y	Yellow	Bus Lamps (90327Y, 6503A, 6504)
99169R	Red	Bus Lamps (90326R, 6507)
99169Y	Yellow	Bus Lamps (90326Y, 6507)
99021R	Red	Bus Lamps (91312R, 91812R, 91315R)
99021Y	Yellow	Bus Lamps (91312Y, 91812Y)
99088C	Clear	Dome & Utility (80354, 80355, 80356, 80357, 90320R/Y, 90321R/Y)
99088R	Red	Lamps (80354, 80355, 90320R/Y, 90321R/Y)

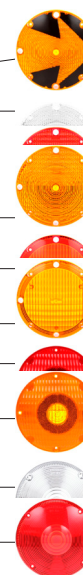

**ROUND, 7",
THREADED FIT**

Part Number	Lens Color	Compatible Parts
99250C	Clear	Strobes & Beacons (92565C, 92568C, 92592Y)
99250B	Blue	Strobes & Beacons (92565B, 92568B)
99250Y	Yellow	Strobes & Beacons (92569Y, 92565Y, 92566Y, 92568Y)
99252C	Clear	Strobes & Beacons (92564C)
99252Y	Yellow	Strobes & Beacons (92564Y)

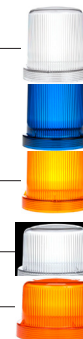

**ROUND, 8",
2-SCREW**

Part Number	Lens Color	Compatible Parts
99143C	Clear	Strobes (92500Y, 92506Y, 02513Y, 92513C)
99143Y	Yellow	Strobe (92600Y)



**OVAL, 1"X 3",
SNAP-FIT**

Part Number	Lens Color	Compatible Parts
8946	Red	M/C Lamps (1505, 1506)
8946A	Yellow	M/C Lamps (1505A, 1506A)
8946W	Clear	M/C Lamps (1505W, 1506W)
9061A	Yellow	M/C Lamps (1550, 1551)

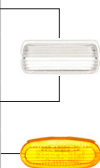

**OVAL, 1"X 4",
SNAP-FIT**

Part Number	Lens Color	Compatible Parts
99041R	Red	Grote, Signal-Stat
99041Y	Yellow	Grote, Signal-Stat
99050R	Red	M/C Lamps (26312R, 26317R)
99050Y	Yellow	M/C Lamps (26312Y, 26317Y)
99051R	Red	M/C Lamps (26310R)
99051Y	Yellow	M/C Lamps (26310Y)
8937	Red	M/C Lamps (1555)
8937A	Yellow	M/C Lamps (1555A)

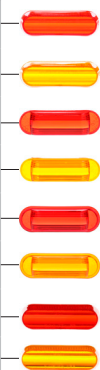

**OVAL, 2"X 3",
1-SCREW**

Part Number	Lens Color	Compatible Parts
8977A	Yellow	Dietz 2-18 Series
9087	Red	Cab Markers (1312A)
9087A	Yellow	Cab Markers (1312)

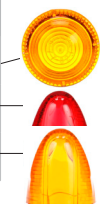

**OVAL, 2"X 4",
SNAP-FIT**

Part Number	Lens Color	Compatible Parts
99027Y	Yellow	26 Series PC Rated Bulb (26902Y)
99043R	Red	Betts Lamps
99043Y	Yellow	Betts Lamps
8933	Red	M/C Lamps (1263, 1264)
8933A	Yellow	Economy Mirrors (97628, 97629, 97627, 97630, 97631) M/C Lamps (1263, 1264A)
9007A	Yellow	M/C Lamps (1201, 1203, 1204, 1211A, 1213A, 1215, 1216A, 1253)
9007B	Blue	M/C Lamps (1201, 1203, 1204, 1211, 1213, 1215, 1216, 1253)
9007W	Clear	M/C Lamps (1201, 1203, 1204, 1211, 1213, 1215, 1216, 1253)
9007GA	Green	M/C Lamps (1201, 1203, 1204, 1211, 1213, 1215, 1216, 1253)
9006	Red	M/C Lamps (1201, 1203, 1204)
9006A	Yellow	M/C Lamps (1201, 1203A, 1204)
9093	Red	M/C Lamps (1258, 1259, 1262)
9093A	Yellow	M/C Lamps (1258, 1259A, 1262)
9093B	Blue	M/C Lamps (1258, 1259B, 1262)
9093W	Clear	M/C Lamps (1258, 1259, 1262)
9093GA	Green	M/C Lamps (1258, 1259, 1262)



**OVAL, 2"X 5",
1-SCREW**

Part Number	Lens Color	Compatible Parts
99067R	Red	Cab Marker (26765Y, 1320, 1320AD, 1320A, Signal-Stat 9067/A)
99067Y	Yellow	Cab Marker (26765Y, 1320, 1320AD, 1320A, Signal-Stat 9067/A)



**OVAL, 2"X 6~",
2-SCREW**

Part Number	Lens Color	Compatible Parts
9077	Red	M/C Lamps (1233, 1235, 1205)
9077A	Yellow	M/C Lamps (1233A, 1235, 1205)
9077W	Clear	M/C Lamps (1205, 1233, 1235)
99011R	Red	Front, Rear Lighting (60302R)
99011Y	Yellow	Lamps (60 Series)

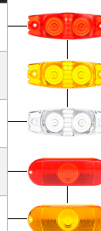

REPLACEMENT LENSES

**OVAL, 2"X 7",
SNAP-FIT**

Part Number	Lens Color	Compatible Parts
99184C	Clear	Dome & Utility (60340R/Y, 60345C, 60834C)
99184R	Red	Front, Rear Lighting (60340R, 60345C, 60834C, 60344R)
99184Y	Yellow	Front, Rear Lighting (60340Y, 60345C, 60834C, 60344Y)



OVAL

**OVAL, 3"X 5",
SNAP-FIT**

Part Number	Lens Color	Compatible Parts
9001	Red	502, 505, 510



RECTANGULAR

**OVAL, 3"X 7",
1-SCREW**

Part Number	Lens Color	Compatible Parts
80572	Clear	Headlamps-Fog & Driving Lamps (80520)
80573	Clear	Headlamps-Fog & Driving Lamps (80521)
80574	Yellow	Headlamps-Fog & Driving Lamps (80522)

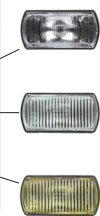

**OVAL, 5"X 7"
3-SCREW**

Part Number	Lens Color	Compatible Parts
99158Y	Yellow	92620Y

**RECTANGULAR, 1"X 2",
SNAP-FIT**

Part Number	Lens Color	Compatible Parts
99160C	Clear	M/C Lamps (26311, 26313) Signal Stat Lamps (1113, 1114)
9082	Red	M/C Lamps (1520, 1520HT, 1521, 1523)
9082A	Yellow	M/C Lamps (1520A, 1520 AHT, 1521, 1523)
9342	Red	M/C Lamps (1507)
9342A	Yellow	M/C Lamps (1507A)

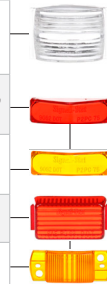

**RECTANGULAR, 1"X 3",
SNAP-FIT**

Part Number	Lens Color	Compatible Parts
9005	Red	M/C Lamps (1101, 1102, 1105, 1108, 9365, 9366, 9369)
9005A	Yellow	M/C Lamps (1101, 1102, 1105, 1108, 9365, 9366, 9369)
9005W	Clear	M/C Lamps (1101, 1102, 1105, 1108, 9365, 9366, 9369)
9059	Red	M/C Lamps (1550, 1551)
9059A	Yellow	M/C Lamps (1550, 1551)
9059W	Clear	M/C Lamps (1550, 1551)
9061	Red	M/C Lamps (1550, 1551)

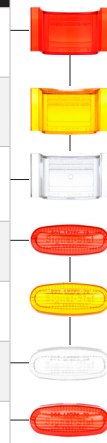

**RECTANGULAR, 1"X 6",
SNAP-FIT**

Part Number	Lens Color	Compatible Parts
8918	Red	Signal Lighting Lamps (4091)
8918A	Yellow	Signal Lighting Lamps (4091A)

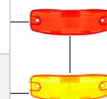

**RECTANGULAR, 1"X 23",
SNAP-FIT**

Part Number	Lens Color	Compatible Parts
99233C	Clear	-
99234C	Clear	-

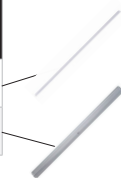

**RECTANGULAR, 2"X 2",
SNAP-FIT**

Part Number	Lens Color	Compatible Parts
99160R	Red	M/C Lamps (26311R, 26313R) Signal Stat (1113, 1114)
99160Y	Yellow	M/C Lamps (26311Y, 26313Y) Signal Stat (1113, 1114)

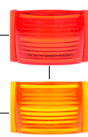

**RECTANGULAR, 2"X 3",
2-SCREW**

Part Number	Lens Color	Compatible Parts
8947	Red	M/C Lamps (1570) Trailer Lamps (533DK, 534D, 535D)
8947A	Yellow	M/C Lamps (1570A) Trailer Lamps (533DK, 534D, 535D)
9371	Red	1571
9371A	Yellow	1571AD

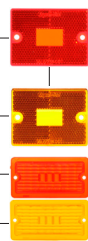

**RECTANGULAR, 2"X 4",
SNAP-FIT**

Part Number	Lens Color	Compatible Parts
8939A	Yellow	Pedestal Lamps (4742, 4754)
9007	Red	Headlamps-Fog & Driving (27004) Lighting Kit (80893) M/C Lamps (1201, 1203, 1204, 1211, 1213, 1215, 1216, 1253)
9057	Red	M/C Lamps (1221,1222)
9057A	Yellow	M/C Lamps (1221,1222A)



**RECTANGULAR, 2"X 4",
1-SCREW**

Part Number	Lens Color	Compatible Parts
99170R	Red	Bus Lamps (26353R, 1151)
99170Y	Yellow	Bus Lamps (26353Y, 1151)



**RECTANGULAR, 2"X 4",
2-SCREW**

Part Number	Lens Color	Compatible Parts
99238R	Red	M/C Lamps (2660, 2661)
99238Y	Yellow	M/C Lamps (2660A, 2661A)
9080A	Yellow	Pedestal Lamps (4810, 4842, 81331, 4800, 4801, 4805AAY115, 4805AAY118, 4805AY116, 4805AY117)

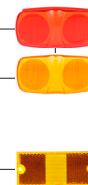

**RECTANGULAR, 2"X 5",
2-SCREW**

Part Number	Lens Color	Compatible Parts
99012R	Red	M/C Lamps (18300R)
99012Y	Yellow	M/C Lamps (18300Y)
8930	Red	M/C Lamps (26315R, 1117)
8930A	Yellow	M/C Lamps (26315Y, 1117)
9771A	Yellow	Lamps (9770A)

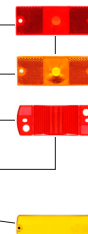

**RECTANGULAR, 2"X 6",
2-SCREW**

Part Number	Lens Color	Compatible Parts
8900	Red	1265, 1265A
8900A	Yellow	1265, 1265A



REPLACEMENT LENSES

**RECTANGULAR, 2"X 23",
SNAP-FIT**

Part Number	Lens Color	Compatible Parts
99236C	Clear	-

**RECTANGULAR, 2"X 47",
SNAP-FIT**

Part Number	Lens Color	Compatible Parts
99235C	Clear	-

**RECTANGULAR, 3"X 5",
SNAP-FIT**

Part Number	Lens Color	Compatible Parts
99086R	Red	Pedestal Lamps (70352, 70353, 70356 & 70357), Signal-Stat (4758, 4759, 8864/A)
99086Y	Yellow	Pedestal Lamps (70352, 70353, 70356 & 70357), Signal-Stat (4758, 4759, 8864/A)

**RECTANGULAR, 3"X 5",
2-SCREW**

Part Number	Lens Color	Compatible Parts
9372	Red	Signal Lighting Lamps (548, 549)
9372A	Yellow	Signal Lighting Lamps (548, 549A)
9373W	Clear	Dome & Utility (549SWD)
80579	Clear	Headlamps-Fog & Driving (80525, 80526)
80580	Yellow	Headlamps-Fog & Driving (80527)
99087R	Red	80308R, 81304R/Y
99087Y	Yellow	80308R, 81304R/Y

RECTANGULAR

**RECTANGULAR, 3"X 7",
2-SCREW**

Part Number	Lens Color	Compatible Parts
99172	Clear	Bus Lamps (81350 Dome)
80569	Yellow	Headlamps-Fog & Driving (80519)
80567	Clear	Headlamps-Fog & Driving (80513, 80514)
80568	Clear	Headlamps-Fog & Driving (80513, 80514)
97724	Clear	West Coast Mirrors 7 in x16 in Box Style

**RECTANGULAR, 3"X 8",
4-SCREW**

Part Number	Lens Color	Compatible Parts
9676	Red	Lamps (528, 529), Trailer Kit (530DK)

**RECTANGULAR, 4"X 5",
SNAP-FIT**

Part Number	Lens Color	Compatible Parts
99126R	Red Clear	Lamps (80317R, 80318R)
99127R	Red	Lamps (80317R, 80318R)

**RECTANGULAR, 4"X 5",
3-SCREW**

Part Number	Lens Color	Compatible Parts
8923	Red	Signal Lighting Lamps (4701, 4702, 4703, 4704)
8923A	Yellow	Signal Lighting Lamps (4701, 4702, 4703, 4704)

**RECTANGULAR, 4"X10.5",
1-SCREW**

Part Number	Lens Color	Compatible Parts
8925A	Yellow	Chrome Cab Marker (1350A)

**RECTANGULAR, 4"X 16",
8-SCREW**

Part Number	Lens Color	Compatible Parts
99245C	Clear	Dome & Utility (80251C)



**RECTANGULAR, 6"X 7",
SNAP-FIT**

Part Number	Lens Color	Compatible Parts
9072	Red	Lamps (5010 Series)



**RECTANGULAR, 6"X 7",
4-SCREW**

Part Number	Lens Color	Compatible Parts
9049	Red	4010 Series, Box Lamps (4025, 4026, 4027, 4028) Trailer Kits (5315Y101, 5316Y101)
9071	Red	Box Lamps (4015, 4016, 4017, 4018, 4023, 4024)



**RECTANGULAR, 7"X 13",
SNAP-FIT**

Part Number	Lens Color	Compatible Parts
99152	Yellow	Signal Lighting Lamps (40802, 40803, 40804, 40805)



**RECTANGULAR, 7"X 16",
6-SCREW**

Part Number	Lens Color	Compatible Parts
99151Y	Yellow	Light Bars (92520Y, 92521Y, 92522Y, 92523Y, 92524Y, 92525Y)



**RECTANGULAR, 10"X 15",
4-SCREW**

Part Number	Lens Color	Compatible Parts
99193Y	Yellow	Light Bars (92674Y, 92675Y, 92676Y, 92677Y)



**RECTANGULAR, 12"X 18",
4-SCREW**

Part Number	Lens Color	Compatible Parts
99203Y	Yellow	Light Bars (92674Y, 92675Y, 92677Y)



**SQUARE, 4"X 4",
SNAP-FIT**

Part Number	Lens Color	Compatible Parts
8006	Red	Direction Indicator Lamps, STT/B/U Lamps (8000, 8001, 8002)
8007	Clear	Direction Indicator Lamps, STT/B/U Lamps (8000, 8001, 8002)
8008	Yellow	Direction Indicator Lamps, STT/B/U Lamps (8000, 8001, 8002)



**SQUARE, 4"X 4",
4-SCREW**

Part Number	Lens Color	Compatible Parts
8960	Red	Pedestal Lamps (940, 941, 950, 955, 956, 957)
8960A	Yellow	Pedestal Lamps (940, 941, 950, 955, 956AA, 957AA)

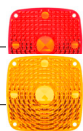

**SQUARE, 4.5"X 4.5",
4-SCREW**

Part Number	Lens Color	Compatible Parts
8948	Red	Trailer Lamps (533DK, 534D, 535D)
9083	Red	Pedestal Lamps (4805AY116, 4805AY117)
9083A	Yellow	Pedestal Lamps (4872AA, 4805AY116, 4805AY117)
9063	Red	Pedestal Lamps (4854, 4855, 4810, 4800, 4801)
9063A	Yellow	Pedestal Lamps (4874AY101, 4810, 4800, 4801)
9074A	Yellow	4852, 4853, 4868, 4869
9078A	Yellow	Pedestal Lamps (4854, 4855)
9079	Red	Pedestal Lamps (4842)
9079A	Yellow	Pedestal Lamps (4842, 81331, 4805AAY115, 4805AAY118)

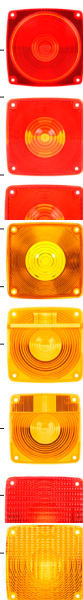

**SQUARE, 5"X 5",
SNAP-FIT**

Part Number	Lens Color	Compatible Parts
8938	Red	Pedestal Lamps (4742, 4754)
8938A	Yellow	Pedestal Lamps (4742, 4754)
9084A	Yellow	Pedestal Lamps (5800AA, 5800AAK)

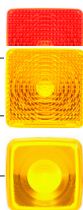

**SQUARE, 7"X 7",
4-SCREW**

Part Number	Lens Color	Compatible Parts
9382	Red	Bus Lamps (6500, 6502)
9382A	Yellow	Bus Lamps (6500A)
9382W	Clear	Bus Lamps (6500, 6502)
9384	Red	Bus Lamps (6501)
9384A	Yellow	Bus Lamps (6501A)

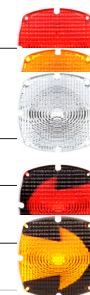

**TRIANGULAR, 2"X 7",
SNAP-FIT**

Part Number	Lens Color	Compatible Parts
07021	Yellow	25761Y

**TRIANGULAR
2.75"X 3.5", SNAP-FIT**

Part Number	Lens Color	Compatible Parts
99165Y	Yellow	Cab Marker (25762Y)
99063R	Red	26771R/Y
99063Y	Yellow	26771R/Y



**TRIANGULAR
3"X 4", 1-SCREW**

Part Number	Lens Color	Compatible Parts
8861	Red	Bus Lamps (1150)
8861A	Yellow	Bus Lamps (1150A)



**BEEHIVE, 2.5",
SNAP-FIT**

Part Number	Lens Color	Compatible Parts
9004	Red	Beehive Lamps, M/C Lamps (1001, 26740R, 26741R)
9004A	Yellow	Beehive Lamps, M/C Lamps (1001AD)
9004G	Green	Beehive Lamps
9004W	Clear	Beehive Lamps



Looking for even more product information?

Visit truck-lite.com



**Powerful Search
Function**









**360° Product
Images**



**Easy-To-Find
Replacement
Parts**

HALOGEN



Part Number	Lamp Style	Bulb Wattage	Volts	Compatible Parts
 80560	H3	100	12	Driving Lamp (613W), Fog Lamp (612W), Headlamp, Off-Road Lights, Work Lamp (610W)
 80561	H3	70	24	Auxiliary & Emergency Lamps, Flood Lamp (629WD), Spot Lamp (628WD), Work Lamp (637W)
 80562	H3	45	36	Driving Lamp (613W), Fog Lamp (612W), Material Handling Industry, Work Lamp (610W)
 80563	H1	55	12	Beacon (6822A, 6823A, 92602R, 92602B), Light Bar (92674Y)
 80564	SC Bayonet	50	12	335 Series Lamp
 80571	H3	55	12	Driving Lamps (613W, 80520, 80513, 80525), Flood Lamps (80491, 80494, 629WD, 80493), Fog Lamps (612W, 80521, 80522, 80514, 80519, 80526, 80527), Off-Road Lights, Spot Lamps (80492, 628WD), Work Lamps (80498, 627WD, 637W, 610W)
 92722		50	12	Light Bar (92669Y, 92668Y)

HALOGEN (CONTINUED)



	Part Number	Lamp Style	Bulb Wattage	Volts	Compatible Parts
	80596	9003LL	72/65	12	Dual Headlamp Systems, Headlamp (27012, 27009)
	80597	9004LL	70/50	12	Dual Headlamp Systems
	80598	9005LL	70	12	Dual Headlamp Systems
	80599	9006LL	55	12	Dual Headlamp Systems
	92883		23	12	92620Y

INCANDESCENT

INCANDESCENT



Part Number	Lamp Style	Bulb Wattage	Volts	Compatible Parts
80604	T4-5/8	20	12	Dome & Utility (20302, 20308), Turn Signal Lamp (20309Y, 20310Y)
80700	—	—	—	F15T8 Tubes

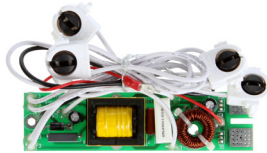

STROBE TUBE

STROBE TUBE



Part Number	Bulb Wattage	Volts	Compatible Parts
88-43210	25	12	300, 301, 302, 309 & 337 Series Strobe Lamps



ROTATOR ASSEMBLY



Part Number	Lighting Technology	Lamp Connection	Plug Side 2	Housing Material
92720	Halogen	Hardwired	Stripped End	Plastic

ROTATOR ASSEMBLY

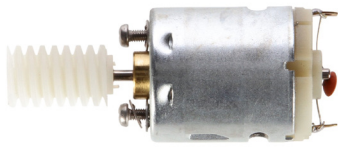

ROTATOR ASSEMBLY



Part Number	Lamp Connection	Housing Material
92721	Two Blade	Steel

ROTATOR ASSEMBLY



FREE FORM ROTATOR MODULE

FEATURES

- 18' harness exits on driver's side
- Built-in rear traffic director
- Extruded aluminum frame will not warp or bend
- Features dual decks for power & flexibility
- H1 55 watt halogen rotating assemblies
- Popular use for utility, construction, security & towing applications



Part Number	Lighting Technology	Lamp Connection	Plug Side 2	Housing Material
92800	Halogen	Hardwired	Blade Terminal Stripped End	Plastic

ROTATOR MODULE

STROBE MOUNTING MAGNET, STEEL



FEATURES

- Magnets are coated to reduce the likelihood of scratching the paint of a towed vehicle onto which these lamps are mounted

Part Number	Housing Material	Mount Type
217-58	Steel	110lb Pull Force

STROBE MOUNTING MAGNET, RUBBER



FEATURES

- Magnetic Mount Base

Part Number	Housing Material	Mount Type
92547	Steel	120lb Pull Force

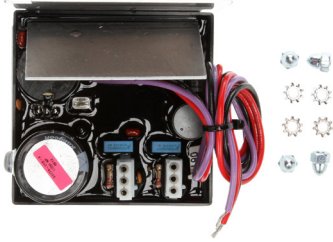

MINIBARS, HARDWIRED, STRIPPED END, 12-24V



Part Number	Lamp Connection	Plug Side 1	Plug Side 2	Housing Material	Housing Color
92716	Hardwired	Hardwired	Stripped End	Silver	Aluminum

ELECTRO-MECHANICAL, 2 BLADE TERMINAL



PART# 172, 182, 282 FEATURES

- Certification for 16 bulb capacity for hazard warning
- Flashes up to eight 32 CP bulbs per side, plus pilot bulb
- 35 amp capacity at 12VDC
- Low profile, only 1-1/4" height above terminals

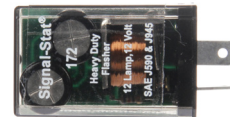
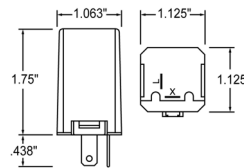

PART# 262 FEATURES

- Flashes at a rate of 60 to 120 FPM, with first flash less than 1.5 seconds after startup
- Bi-polar flasher functions continuously at 13V for 36 hours with 10-32 CP lamps, 20 AMP max
- Uses standard 1/4" male blade terminals
- Features double coil relay with electronic components
- Replaces Truck-Lite 97202/03/04 series

Part Number	Flash Rate Min_FPM	Flash Rate Max_FPM	Lamp Capacity	Terminal Count	Volts	Standards Met
172	70	120	12	2	12	J590, J945
182	70	120	16	2	12	J590, J945, J1054
262	60	120	10	2	12	J590, J945
282	70	120	20	2	12	J590, J945, J1054

ELECTRO-MECHANICAL, 3 BLADE TERMINAL



FEATURES

- Flashes at a rate of 70 to 120 FPM, with first flash less than 1.3 seconds after startup
- Functions at 13v for 36 continuous hours with 16-32 cp lamps at 35 amp max (#182 and 183), 20-32 cp lamps at 45 amp max (#282 and 283)
- Five available versions include 16-lamp with 2- or 3- terminal, 20-lamp with 2- or 3- terminal and alternating 10-lamp with 3- terminal
- ISO relay with electronic control circuits
- Replaces Truck-Lite 97205 & 97209

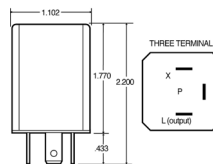

Part Number	Flash Rate Min_FPM	Flash Rate Max_FPM	Lamp Capacity	Terminal Count	Volts	Standards Met
173	70	120	12	3	12	J590, J945, J1054
183	70	120	16	3	12	J590, J945, J1054
283	70	120	20	3	12	J590, J945, J1054

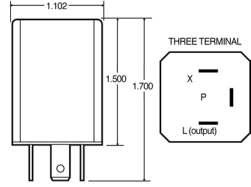

**ELECTRO-MECHANICAL,
3 BLADE TERMINAL**

FEATURES

- 2-4 lamp load capability with outage indication
- 8 for hazard warning
- Third prong used for ground function



Part Number	Flash Rate Min_FPM	Flash Rate Max_FPM	Lamp Capacity	Terminal Count	Volts	Standards Met
264	70	100	4	3	12	J590, J945
266	70	100	6	3	12	J590, J945

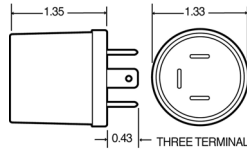

**ELECTRO-MECHANICAL,
3 BLADE TERMINAL**

FEATURES

- 2-4 lamp load capability with outage indication
- 8 for hazard warning
- Third prong used for ground function



Part Number	Flash Rate Min_FPM	Flash Rate Max_FPM	Lamp Capacity	Terminal Count	Volts	Standards Met
263	60	120	10	3	12	J590, J945
2634	60	120	10	3	24	J590, J945

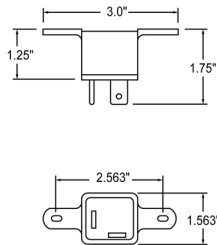

**ELECTRO-MECHANICAL,
2 BLADE TERMINAL, 2 SCREW**

FEATURES PART# 242

- Certification for 16 bulb capacity for hazard warning
- Flashes up to eight 32 CP bulbs per side, plus pilot bulb
- 35 amp capacity at 12VDC
- Low profile, only 1-1/4" height above terminals



Part Number	Flash Rate Min_FPM	Flash Rate Max_FPM	Lamp Capacity	Terminal Count	Volts	Standards Met
242	60	120	16	2	12	J590, J945t

ELECTRO-MECHANICAL, 2 SCREW, HARDWIRED



FEATURES

- Mack 47M019301P2 (SS# 250)
- Conforms to DOT and SAE specifications
- Test proven to exceed 1.5 million cycles of continuous operation at maximum capacity without failure
- Certified for ten bulb load hazard warning, five bulb load turn signal, plus pilot
- Polycarbonate housing and brass terminals for superior corrosion resistance and better conductivity
- #256 For school buses or emergency vehicles
- #256 Flashes two 75 watt sealed beams per circuit

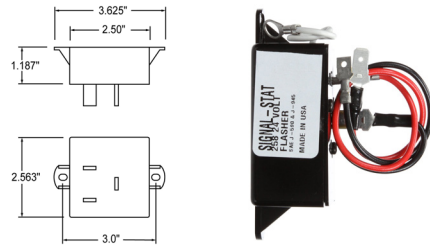

Part Number	Flash Rate Min_FPM	Flash Rate Max_FPM	Plug Side Two	Lamp Capacity	Volts	Standards Met
250	60	90	2 Spade Terminal, Ring Terminal	10	12	J590,J945,J1054
256	60	90	3 Spade Terminal Ring, Terminal	2	12	J590,J945,J1054
2584	60	120	Spade Terminal Ring, Terminal	10	12	J590,J945,J1054

ELECTRO-MECHANICAL, HARDWIRED



FEATURES

- Hardwired allowing alternating flashing of up to 20 LED lamps (10 lamps per side)
- Color coded wires, epoxy-sealed circuitry and installation instructions
- Operates on 12V or 24V systems
- Warning Lamp types flasher
- Maximum 5 amp load
- Flashes 3 times per 1/2 second

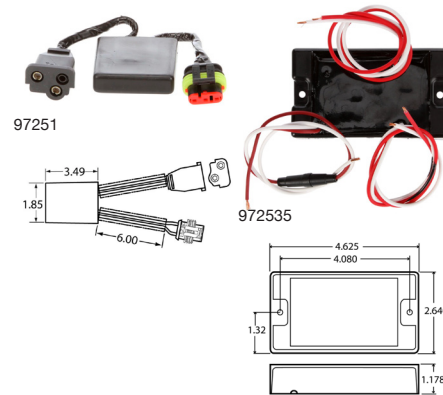

Part Number	Flash Rate Max_FPM	Plug Side Two	Volts
97235	360	Stripped End	12 24
97251	480	Fit 'N Forget S.S./ Straight Female PL-2	12 24

ELECTRO-MECHANICAL, LED 2 SCREW, HARDWIRED



FEATURES

- Designed for use in automotive and heavy duty applications
- Creates a strobe flash on an LED lamp
- Hardwired design eliminates pin corrosion
- Features coded wires and epoxy sealed circuitry for durability and long term use
- Designed to operate in temperature range -40°C to 85°C
- Full operation voltage range 12V to 24V
- Maximum current 7 amps
- Flashes 3 times per 1/2 second
- Uses 2 modules as alternating LED strobe without cutting or splicing

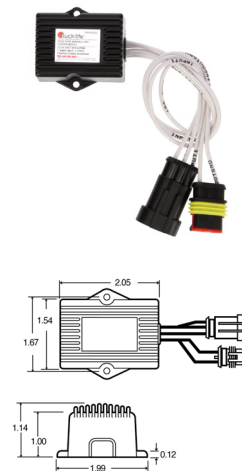

Part Number	Flash Rate Max_FPM	Plug Side Two	Volts
97253	360	Fit 'N Forget S.S./ 3 Position Connector 282105	12 24

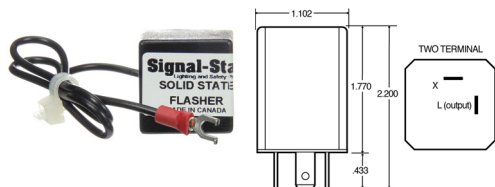

SOLID-STATE, LED FLASHER, HARDWIRED



FEATURES

- This solid-state flasher operates from 1 milliamp up to 6 amps - allowing the use of two incandescent signal lamps with LED S/T/T lamps
- Solid-state timing circuitry provides reliability
- Flashes at a rate of 90 FPM
- Size: 1-1/8" W x 1-5/8" H

Part Number	Flash Rate Max_FPM	Plug Side Two	Volts	Standards Met
285	90	Spade Terminal Fork Terminal	12	J590, J945

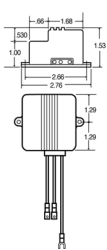

HEAVY-DUTY SOLID-STATE, LED+INCANDESCENT, 2 SCREW, HARDWIRED



FEATURES

- Rated for 42 amp load
- For use on double and triple trailer combination, sanitation vehicles, delivery and courier vehicles, heavy haulers and emergency vehicles
- Operates LED lamps as well as incandescent lamps
- Flasher unit includes 11" of wiring for remote mounting

Part Number	Flash Rate Min_FPM	Flash Rate Max_FPM	Plug Side Two	Volts	Amp	Pilot	Standards Met
270	80	100	2 Spade Terminal Fork Terminal	12	40	No	J590, J945, J1054
270Y1014	80	100	2 Spade Terminal Fork Terminal	24	40	No	J590, J945, J1054
275	80	100	3 Spade Terminal Fork Terminal	12	40	Yes	J590, J945, J105
276	81	99	3 Spade Terminal Fork Terminal	12	20	-	J590, J945, J1054

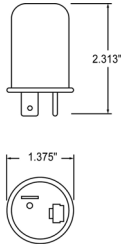

THERMAL, 2 BLADE TERMINALS

FEATURES

- Heavy duty, longer life, variable load
- Flashes up to three 32 cp bulbs per side, plus pilot bulb (550 only)
- Flashes up to six 32 cp bulbs for hazard warning
- Aluminum housing



Part Number	Flash Rate Min_FPM	Flash Rate Max_FPM	Volts	Standards Met
536	60	120	12	J590b J945
552	60	120	12	J2068

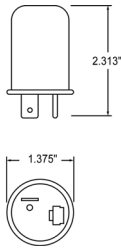

THERMAL, 3 BLADE TERMINALS

FEATURES

- Heavy duty, longer life, variable load
- Flashes up to three 32 cp bulbs per side, plus pilot bulb (550 only)
- Flashes up to six 32 cp bulbs for hazard warning
- Aluminum housing



Part Number	Flash Rate Min_FPM	Flash Rate Max_FPM	Volts	Standards Met	Notes
550	60	120	12	J590b J945	with Pilot

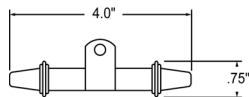

THERMAL, HARDWIRED

FEATURES

- 6 amp capacity @ 12 VDC
- Includes spade terminals for ease of installation
- Brass housing for corrosion resistance
- Mounts via single screw
- 4" lead wires



Part Number	Flash Rate Min_FPM	Flash Rate Max_FPM	Plug Side Two	Volts	Standards Met
245	60	120	Spade Terminal	12	J590, J945

UNIVERSAL

UNIVERSAL FLASHER CONNECTOR, 3 FEMALE BLADE TERMINALS



FEATURES

- Exclusive design accommodates 2 or 3 prong flashers
- Includes 15 amp blade type fuse
- Ring terminal on lead wire
- For use with 12V or 24V applications

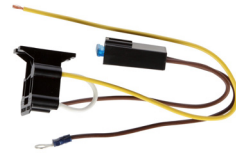

Part Number	Plug Side Two	Volts
9187	Stripped End Ring Terminal	12 24

FLASHER CONNECTOR

FLASHER CONNECTOR, 3 FEMALE BLADE TERMINALS



FEATURES

- Includes 15 amp blade type fuse
- Ring terminal on lead wire
- 7" color coded wire leads
- Insulated 16 gauge wire leads
- For use with 12V or 24V applications

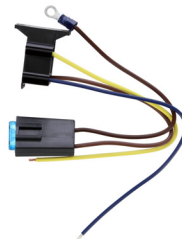

Part Number	Plug Side Two	Volts
9186	Stripped End/ Ring Terminal	12 24

DRL SYSTEM

DRL SYSTEM, HARDWIRED, BLUNT CUT



FEATURES

- Operates low beam headlights at reduced intensity (75%) for prolonged lamp life
- Unit features 15-second "time-in" delay and tail/ marker lamp activation
- Park brake disable feature locks out system when parking brake is engaged
- Electronics are sealed in epoxy for protection and are short circuit protected
- Exceeds GM and Ford's electrical, environmental, RFI and EMI specifications
- Meets or exceeds SAE, NHTSA and CSA guidelines

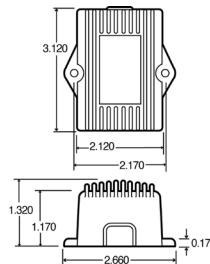

Part Number	Volts	Housing Material
97302	12	Steel



DELIVERING INNOVATION FOR
66 YEARS AND BEYOND.

5 BLADE TERMINAL

5 BLADE TERMINAL



- Heavy-duty relay
- These relays replace both Hella and Bosch units

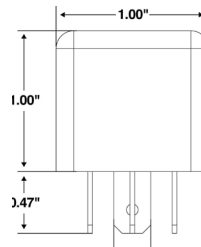

Part Number	Amps	Volts	Housing Material
190	40	12	PC

5 BLADE TERMINAL

5 BLADE TERMINAL



- Heavy-duty relay
- These relays replace both Hella and Bosch units

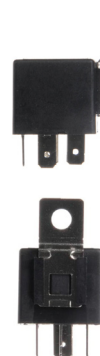
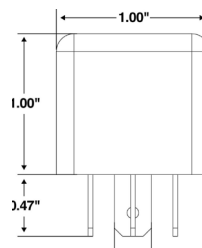

Part Number	Amps	Volts	Housing Material
191	40	12	PC
192	40	12	PC
192D	40	12	PC
1924	22	24	PC

Display packaging

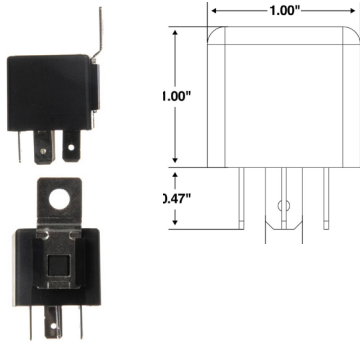

4 BLADE TERMINAL

- These relays replace both Hella and Bosch units



Part Number	Amps	Volts	Housing Material
194	40	12	PC

4 BLADE TERMINAL

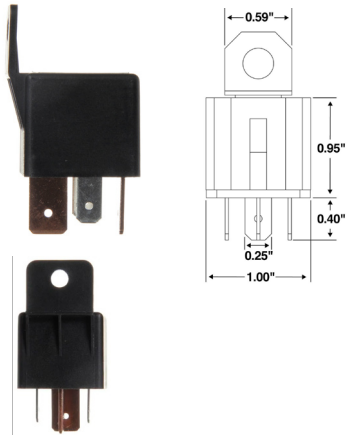

4 BLADE TERMINAL

- These relays replace both Hella and Bosch units



Part Number	Amps	Volts	Housing Material
195	70	12	PC

4 BLADE TERMINAL



4 BLADE TERMINAL, KIT

FEATURES

- Recommended for use where heavy amp draw is required
- Includes 20 feet of 14 gauge wire, connectors, mounting hardware and wiring diagram



Part Number	Amps	Volts	Housing Material
125	70	12	PC

4 BLADE TERMINAL

LIGHT MOUNTING

LIGHT HOUSING

Pages 316-317

LIGHT MOUNTING BRACKETS & FLANGES

Pages 318-344

Series	Page
10 Series	318-321
12 Series	321
15 Series	321-325
17 Series	326
18 Series	326
19 Series	326-329
21 Series	329
26 Series	329-330
30 Series	330-333
33 Series	334-336
35 Series	336
36 Series	336
40 Series	336-339
45 Series	340
60 Series	340-342
Bracket Mount	342-343
Covers	343-344

LIGHT MOUNTING HARDWARE

Pages 344-345

LIGHT MOUNTING GASKETS

Pages 345-349

GROMMET MOUNTS

Pages 350-355

Series	Page
10 Series	350-351
14 Series	352
15 Series	352
30 Series	352-353
33 Series	353
40 Series	354
44 Series	354
45 Series	354
60 Series	355

LIGHT HOUSING

WORK LAMP HOUSING, 1 STUD MOUNT, 5" ROUND



FEATURES

- Ideal for agricultural applications
- Screw-on bulb connections for positive contact and easy bulb replacement
- Single wire, stud ground
- Weather proof rubber shell protects sealed beam for longer life
- Shell remains flexible from -40 degrees to +125 degrees
- Adjustable bracket with 5/16" diameter stud

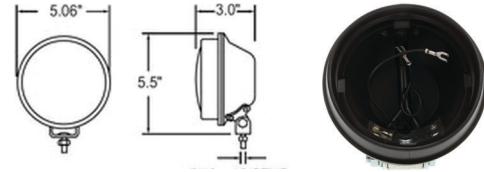

Part Number	Compatible Parts	Material
620H	620W, 620W-4, Par36	Rubber

LIGHT HOUSING

WORK LAMP HOUSING, 1 STUD MOUNT, 5" ROUND



FEATURES

- Durable synthetic rubber housing resists corrosion
- Includes mounting hardware
- Universal mount uses one 5/16"-18 stud

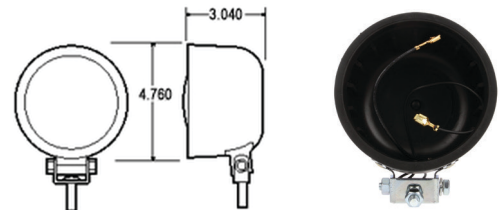

Part Number	Compatible Parts	Material
97980	80202, 80203, 80200, Par36	Rubber

LIGHT HOUSING

WORK LAMP HOUSING, 1 STUD MOUNT, 5" ROUND



FEATURES

- Screw-on bulb connections for positive contact and easy bulb replacement
- Single wire-stud ground
- Weatherproof rubber shell for extended bulb life
- Shell remains flexible from -40 degrees to +125 degrees F°
- 1/2" dia adjustable ball stud

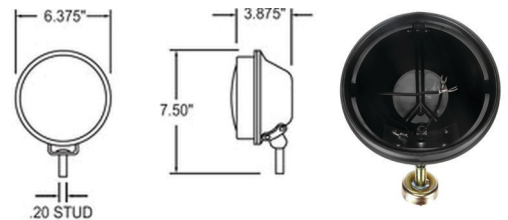

Part Number	Compatible Parts	Material
630H	630W, 630W-4, 632W, Par46	Rubber

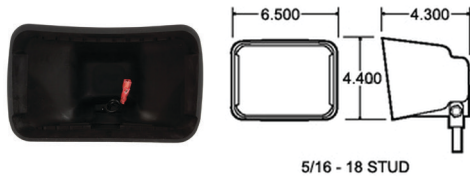

WORK LAMP HOUSING, 1 STUD MOUNT, RECTANGULAR

FEATURES

- Durable synthetic rubber housing resists corrosion
- Includes mounting hardware
- Universal mount uses one 5/16"-18 stud



Part Number	Compatible Parts	Material
97989	80388, 80389, 80394, 80395, 80396, 80397	Rubber

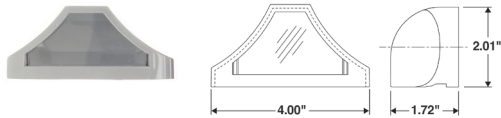

LICENSE PLATE LAMP LENS HOOD, GRAY

- Lens hood for 425



Part Number	Compatible Parts	Material
8951W	425	Gray ABS

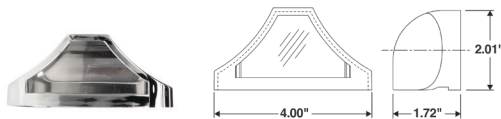

LICENSE PLATE LAMP LENS HOOD, CHROME

- Lens hood for 425



Part Number	Compatible Parts	Material
8952W	425	Chrome ABS



MODEL 60 HOUSING ASSEMBLY

Part Number	Compatible Parts	Material
60789	99011Y, 99011R	White PC

- HSNB-CHMSL
- Bulb Replacement, Mdl 60 Housing Assembly



10 SERIES

10 SERIES, SURFACE MOUNT, CAM ON/OFF BRACKET



FEATURES

- Rust resistant, stainless steel mount
- Quick cam-on, cam-off lamp installation
- Suitable for PC requirements on a 45-degree angle using all 2-1/2" diameter lamps
- Mounts with screws to surface
- Model 10 kits available
- Not recommended for use with Signal-Stat LED products
- Replaces Signal-Stat 9394

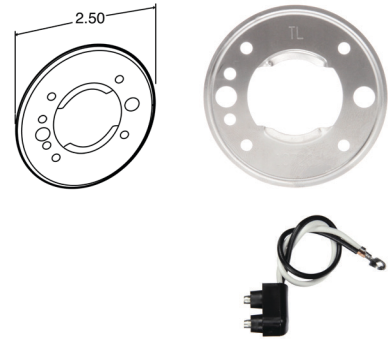

Part Number	Mount Material	Mount Color	Lamp Connection	Plug Side 1	Plug Side 2	Kit Includes
10720	Stainless Steel	Silver	—	—	—	—
10400	Stainless Steel	Silver	PL-10	PL-10	Stripped End/ Ring Terminal	10720 bracket, 94902 plug (KIT)

10 SERIES

10 SERIES, SURFACE MOUNT BRACKET



FEATURES

- Branch deflector cams-on 2 and 2 1/2" lamps
- High-impact plastic mount
- Requires 94924 side entry plug
- Suitable for PC requirements on a 45-degree angle when using LED or incandescent PC rated/combination lamps
- Not recommended for use with Signal-Stat LED products



Part Number	Mount Material	Mount Color	Back	Lamp Connection	Plug Side 1	Plug Side 2	Kit Includes
10721	PC	Clear	—	—	—	—	—
10724	PC	Gray	—	—	—	—	—
10727	PC	Clear	Rib Back	—	—	—	—
10728	PC	Gray	Rib Back	—	—	—	—
10410	PC	Gray	Rib Back	PL-10	PL-10	Stripped End/ Ring Terminal	10728 bracket, 94924 plug (KIT)

10 SERIES

10 SERIES, BRACKET MOUNT, 2 SCREW



FEATURES

- Black epoxy painted heavy gauge steel
- 10729 is designed for mounting grommets: #10700, #10701, #10713, #10714 and #10708, 10714, 107714
- 10730 is designed for mounting grommets: #10704 and #10706

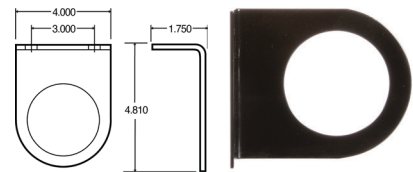

Part Number	Mount Material	Mount Color
10729	Steel	Black
10730	Steel	Black

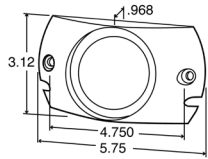

10 SERIES, SURFACE MOUNT BRACKET

FEATURES

- High-impact plastic deflector mount
- Design allows surface mounting of 2-1/2" lamps
- Suitable for PC requirements on a 45-angle when using LED or incandescent PC rated/combination lamps
- Use with 10700 grommet



Part Number	Mount Material	Mount Color
10731	PC	Black
10738	PC	Gray

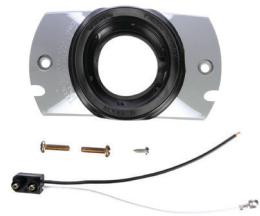

10414 - kit

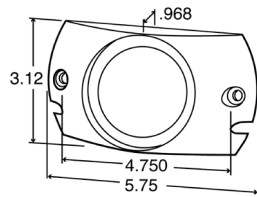

10 SERIES, SURFACE MOUNT BRACKET

FEATURES

- High-impact plastic deflector mount
- Design allows surface mounting of 2-1/2" lamps
- Suitable for PC requirements on a 45-angle when using LED or incandescent PC rated/combination lamps



Part Number	Mount Material	Mount Color	Lamp Connection	Plug Side 1	Plug Side 2	Kit Includes
10725	PC	Gray	—	—	—	—
10414	PC	Gray	PL-10	PL-10	Stripped End/ Ring Terminal	10725 bracket, 10700 grommet, 94902 plug, H5318 Grommet KIT

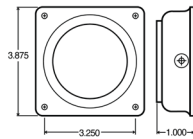

10 SERIES, SURFACE MOUNT BRACKET

FEATURES

- Design allows surface mounting of 2-1/2" lamps in a grommet
- Suitable for PC requirements on a 45-degree angle when using LED or incandescent PC rated/combination lamps



Part Number	Mount Material	Mount Color	Lamp Connection	Plug Side 1	Plug Side 2	Kit Includes
10722	Aluminum	Silver	—	—	—	—
10412	Aluminum	Silver	PL-10	PL-10	Stripped End/ Ring Terminal	10722 bracket, 10700 grommet, 94902 plug KIT

10 SERIES

10 SERIES, SURFACE MOUNT BRACKET , CLOSED BACK



FEATURES

- Design allows surface mounting of 2-1/2" lamps in a grommet
- Suitable for PC requirements on a 45-degree angle when using LED or incandescent PC rated/combination lamps

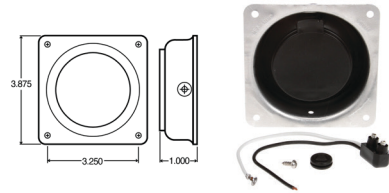

Part Number	Mount Material	Mount Color	Lamp Connection	Plug Side 1	Plug Side 2	Kit Includes
10413	Aluminum	Silver	PL-10	PL-10	Stripped End/ Ring Terminal	10722 bracket, 10702 grommet, 94902 plug

10 SERIES

10 SERIES, M/C ID BAR BRACKET



FEATURES

- Bracket is angle cut to fit most tanker applications
- Designed for mounting grommets requiring 2.781" hole, #10700, #10701, #10713, #10714 and #10708

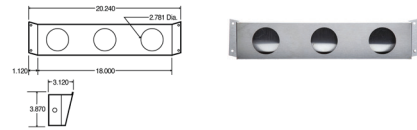

Part Number	Mount Material	Mount Color
10732	Stainless Steel	Silver

10 SERIES

10 SERIES, M/C ID BAR BRACKET



FEATURES

- Rugged stainless steel or black enameled ID bar
- Lamps are mounted on 6" or 9" centers
- Accepts 2" or 2.5" lamps



Part Number	Mount Material	Mount Color	Centers
00794	Stainless Steel	Silver	
00798	Steel	Black	6in
00799	Steel	Black	9in

10 SERIES

10 SERIES, M/C ID BAR BRACKET, 2.5", 2 SCREW



FEATURES

- Black epoxy painted heavy gauge steel
- Designed for mounting grommets: #10704 and #10706

Part Number	Mount Material	Mount Color
00814	Steel	Black

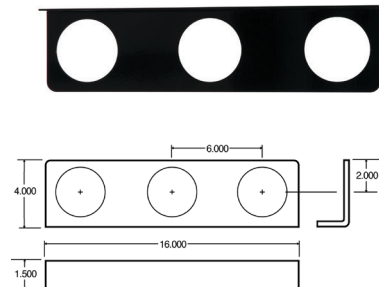

10 SERIES, M/C ID BAR BRACKET, 2.5", 4 SCREW

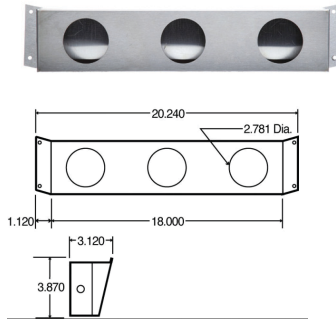

FEATURES

- Bracket is angle cut to fit most tanker applications
- Designed for mounting grommets requiring 2781" hole, #10700, #10701, #10713, #10714 and #10708



Part Number	Mount Material	Mount Color
10732	Stainless Steel	Silver

10 SERIES, FLANGE COVER

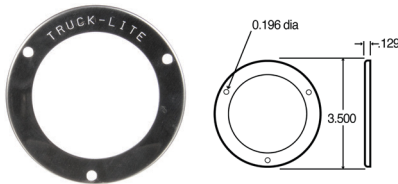

FEATURES

- Designed to enhance appearance of lamps
- Flange cover offers improved theft resistance
- Screws required



Part Number	Mount Material	Mount Color
10715	Stainless Steel	Silver

12 SERIES, SURFACE MOUNT BRACKET

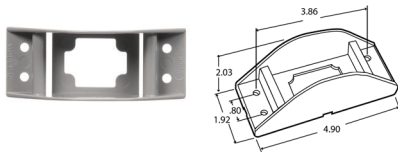

FEATURES

- High-impact plastic branch deflector mount
- Snap-in lamp design for easy replacement
- SAE PC rated for combination clearance/marker applications
- Standard replacement on UPS models



ACCESSORIES

- 97921 Lamp gasket,
- 97925 Bracket Gasket

Part Number	Mount Material	Mount Color
12723	ABS	Gray
12724	ABS	Brown
12725	ABS	Black

15 SERIES, SURFACE MOUNT BRACKET, 1"X2", 2 SCREW

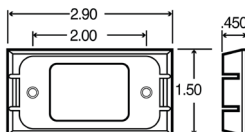

FEATURES

- Stylish design for contemporary look
- Sure contact, self-grounding feature
- Suitable for PC requirements on a 45-degree angle using incandescent lamps



Part Number	Mount Material	Mount Color
00790	ABS	Gray
00791	ABS	Chrome
00802	ABS	Black

15 SERIES

15 SERIES, SURFACE MOUNT BRACKET, 1"X2", 2 SCREW



FEATURES

- Stylish design for contemporary look
- Sure contact, self-grounding feature
- Submersible for marine use

Part Number	Mount Material	Mount Color
00792	ABS	Gray
00793	ABS	Chrome
00809	ABS	Black

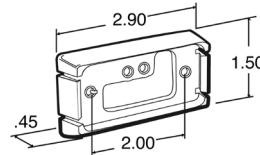

15 SERIES

15 SERIES, LICENSE PLATE BRACKET, 1"X 2", 2 SCREW



FEATURES

- Compatible with LED lamps 15205, 12V, and 15905, 24V, as well as incandescent lamps 15208, 12V and 15209, 24V
- Mounts to a right angle to the license plate
- Bracket is designed to prevent light from shining to rear, positioning lighting directly onto license plate
- Snap-fit lamp mount for quick installation and easy replacement
- An addition to our Model 15 license lamp brackets
- Bracket can be used to convert Model 19 incandescent configurations to Model 15 LED/incandescent configuration

Part Number	Mount Material	Mount Color
15736	PC	Black

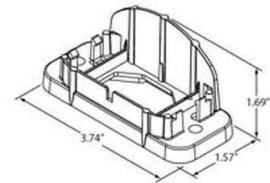
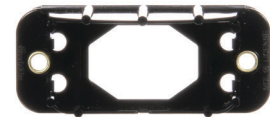

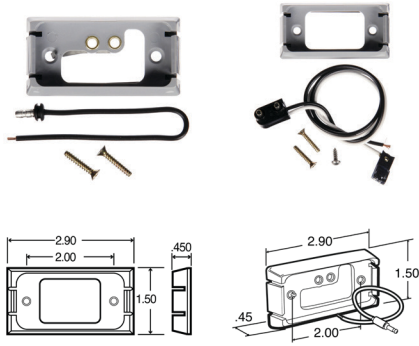

15 SERIES, SURFACE MOUNT BRACKET

FEATURES

- Stylish design for contemporary look
- Sure contact, self-grounding feature
- Suitable for PC requirements on a 45-degree angle using incandescent lamps



Part Number	Mount Material	Mount Color	Lamp Connection	Plug Side 1	Plug Side 2	Kit Includes
15404	ABS	Gray	PL-10	PL-10	Stripped End/Ground Clip	790 bracket, 94906 plug
15405	ABS	Chrome	PL-10	PL-10	Stripped End/Ground Clip	791 bracket, 94906 plug
15406	ABS	Gray	.156 Bullet Hot Wire	.156 Bullet Hot Wire	Stripped End	792 bracket, 96904 plug
15407	ABS	Chrome	.156 Bullet Hot Wire	.156 Bullet Hot Wire	Stripped End	793 bracket, 96904 plug, 97705 wire grommet
15408	ABS	Black	.156 Bullet Hot Wire	.156 Bullet Hot Wire	Stripped End	809 bracket, 96913 hot wire marine
15409	ABS	Chrome	.156 Bullet Hot Wire	.156 Bullet Hot Wire	Stripped End	793 bracket, 96913 hot wire marine

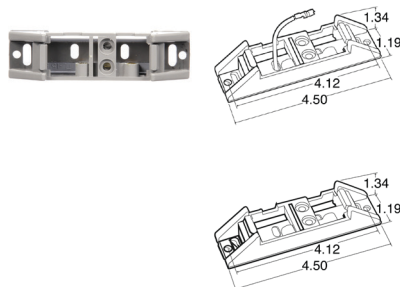

15 SERIES, SURFACE MOUNT, BRANCH DEFLECTOR MOUNT, 2 SCREW

FEATURES

- High-impact plastic construction
- Easy Snap-On lamp installation
- Standard 1" mounting holes
- Permanently affixed hot and ground contacts
- Suitable for PC requirements on a 45-degree angle with incandescent lamps
- Not recommended for use with license lamps



Part Number	Mount Material	Mount Color	Lamp Connection	Plug Side 1	Plug Side 2	Kit Includes
15720	ABS	Gray	—	—	—	—
15401	ABS	Gray	.156 Bullet Hot Wire	.156 Bullet Hot Wire	Stripped End	15720 bracket, 96904 plug



15 SERIES

15 SERIES, RAIL MOUNT, 2 SCREW, KIT



FEATURES

- Extra-strength plastic construction
- Top cut out area on mount #15727 for narrow rail design
- Easy snap-in lamp installation
- Suitable for PC requirements with incandescent lamps

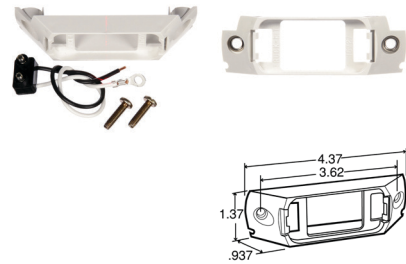

Part Number	Mount Material	Mount Color	Lamp Connection	Plug Side 1	Plug Side 2	Kit Includes
15727	ABS	White	—	—	—	—
15412	ABS	White	PL-10	PL-10	Stripped End/ Ring Terminal	15727 bracket, 94924 plug KIT

15 SERIES

15 SERIES, SURFACE MOUNT BRACKET



Part Number	Mount Material	Mount Color	Lamp Connection	Plug Side 1	Plug Side 2	Kit Includes
15728	ABS	White	—	—	—	—
15733	ABS	Gray	—	—	—	—
15414	ABS	White	PL-10	PL-10	Stripped End/ Ring Terminal	15728 bracket, 94924 plug KIT

15 SERIES

15 SERIES, SURFACE MOUNT, LICENSE PLATE LAMP BRACKET



FEATURES

- Snap-fit mount for quick installation and easy replacement
- Bracket may be surface mounted
- Recommended mounting locations available

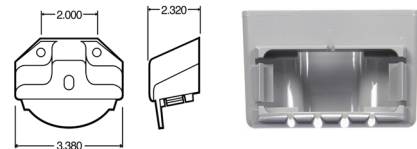

Part Number	Mount Material	Mount Color
15729	PC	Gray
15730	PC	Black
15732	PC	Chrome

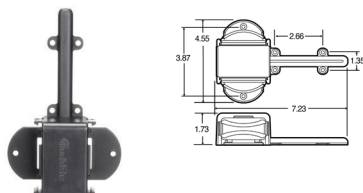

15 SERIES, FENDER MOUNT BRACKET

FEATURES

- Designed for use on most utility trailer fenders
- Available in LED or standard Model 15 kits
- Wire cover is marked in 1/2" increments for easy modifications
- LED and incandescent lamp kits are available



Part Number	Mount Material	Mount Color
15731	ABS	Black

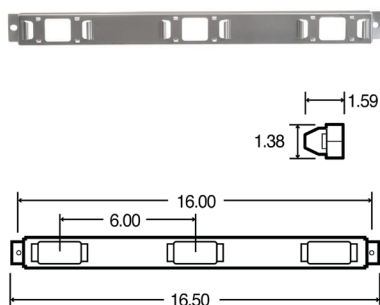

15 SERIES, M/C ID BAR BRACKET

FEATURES

- Rugged stainless steel ID bar designed to fit in limited mounting areas
- Lamps are mounted on 6" centers
- Direct replacement for Ford
- Fits in most narrow header rails
- Snap-lock tabs allow easy installation
- Upgrade to Truck-Lite LED lighting systems using 15 Series products



Part Number	Mount Material	Mount Color
00808	Stainless Steel	Silver

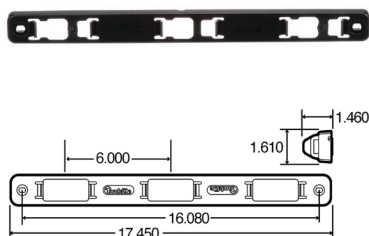

15 SERIES, M/C ID BAR BRACKET, BRACKET MOUNT, 2 SCREW

FEATURES

- High-impact polycarbonate ID bar designed to fit in limited mounting areas
- Lamps are mounted on 6 " centers
- Direct replacement for Ford
- Fits in most narrow header rails
- Snap-lock tabs allow for easy installation
- Replaces Signal-Stat 1515
- 3/8" Screw hole diameter
- Upgrade to Truck-Lite LED lighting systems using 15 Series products



Part Number	Mount Material	Mount Color
00817	PC	Black

17 SERIES

17 SERIES, VERTICLE MOUNT BRACKET, 2", 2 SCREW



FEATURES

- Designed to adapt the Model 17 products to a vertical mounting surface

Part Number	Mount Material	Mount Color
17720	Steel	Black

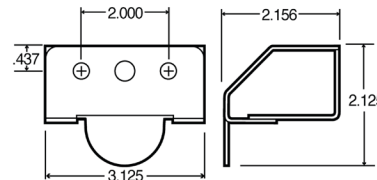

18 SERIES

18 SERIES, SURFACE MOUNT BRACKET, 2"X 5", 2 SCREW



Part Number	Mount Material	Mount Color
92882	PC	Black

19 SERIES

19 SERIES, SURFACE MOUNT BRACKET



FEATURES

- Designed for additional protection of Model 19 base mounts
- Aluminum mount designed with 3" center mounting holes
- Polycarbonate mount designed with 3" and 4.8" center mounting holes
- Not suitable for PC requirements
- Optional mounting gasket available to improve seal between lamp and body

Part Number	Mount Material	Mount Color
19724	Aluminum	Silver

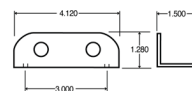

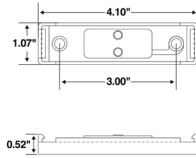

19 SERIES, SURFACE MOUNT CLOSED-BACK BRACKET

FEATURES

- Unique plug-in design for ease of installation
- Low profile, extra strength base
- Suitable for PC requirements on a 45-degree angle
- LED and incandescent lamp kits available



Part Number	Mount Material	Mount Color	Lamp Connection	Plug Side 1	Plug Side 2	Kit Includes
19721	PC	Gray	Hardwired	Hardwired	Stripped End	
19726	PC	Black	Hardwired	Hardwired	Stripped End	
19740	PC	Gray	Hardwired	Hardwired	.180 Bullet	



19720

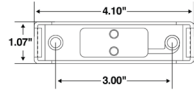

19739



19 SERIES, SURFACE MOUNT, CLOSED-BACK BRACKET MOUNT

FEATURES

- Unique plug-in design for ease of installation
- Low profile, extra strength base
- Suitable for PC requirements on a 45-degree angle
- LED and incandescent lamp kits available



Part Number	Mount Material	Mount Color	Lamp Connection	Plug Side 1	Plug Side 2
19720	PC	Gray	-	-	-
19729	PC	Black	-	-	-
19739	ABS	Chrome	Hardwired	Hardwired	Stripped End



19728

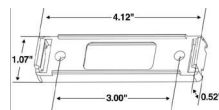

19737

19 SERIES, SURFACE MOUNT, OPEN-BACK BRACKET MOUNT

FEATURES

- Unique plug-in design for ease of installation
- Low profile extra-strength base
- Suitable for PC requirements on a 45-degree angle
- LED and incandescent lamp kits available



Part Number	Mount Material	Mount Color
19728	PC	Black
19737	PC	Gray

19 SERIES

19 SERIES, SURFACE MOUNT, BRACKET



FEATURES

- Popular in trailer and body applications
- Features unique plug-in design for ease of installation
- Must be mounted horizontally
- Low profile extra strength base

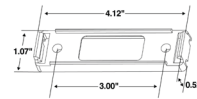

Part Number	Mount Material	Mount Color
19748	ABS	Chrome

19 SERIES

19 SERIES,SURFACE MOUNT, BRANCH DEFLECTOR BRACKET



FEATURES

- Designed for additional protection of Model 19 base mounts
- Aluminum mount designed with 3" center mounting holes
- Polycarbonate mount designed with 3" and 4.8" center mounting holes
- Not suitable for PC requirements
- Optional mounting gasket available to improve seal between lamp and body

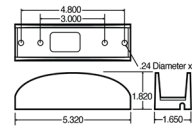

Part Number	Mount Material	Mount Color
19723	PC	Gray

19 SERIES

19 SERIES, SURFACE MOUNT, BRACKET



FEATURES

- Unique plug-in design for ease of installation
- Low profile extra strength base
- Suitable for PC requirements on a 45-degree angle
- LED and incandescent lamp kits available

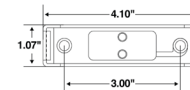

Part Number	Mount Material	Mount Color	Base Mount Radius
19722	PC	Gray	9in
19738	PC	Gray	6.25in
19750	PC	Gray	4.68in

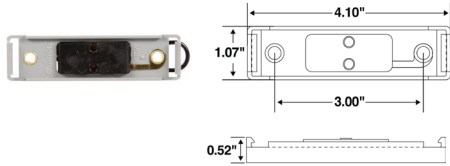

19 SERIES, SURFACE MOUNT BRACKET 2 SCREW KIT

FEATURES

- High-impact plastic mount
- Quick cam-on, cam-off lamp installation
- Suitable for PC requirements on a 45-degree angle using LED or incandescent PC rated/combinatin lamps
- Not recommended for use with Signal-Stat LED lamps



Part Number	Mount Material	Mount Color	Lamp Connection	Plug Side 1	Plug Side 2
19721	PC	Grey	Model 19 Connections	Model 19 Connections	Stripped End/ Ring Terminal
19726	PC	Black	Model 19 Connections	Model 19 Connections	Stripped End/ Ring Terminal

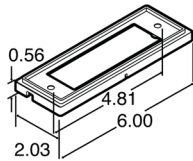

21 SERIES, SURFACE MOUNT BRACKET



Part Number	Mount Material	Mount Color
21720	PC	White
21721	PC	Black

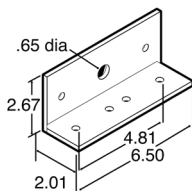

21 SERIES, MOUNT BRACKET, 6 SCREW

FEATURES

- 21722 mounting bracket features electro-painted reinforced steel
- Angle bracket is suitable for mounting the LED Model 21 horizontally
- 97034 is a self-adhesive flat gasket for various mounting applications
- 97036 is a sealing gasket for an improved seal at the rear of the lamp



Part Number	Mount Material	Mount Color
21722	Steel	Black



26 SERIES, SURFACE MOUNT BRACKET, 2"X 4", 2 SCREW



Part Number	Mount Material	Mount Color
92880	PC	Chrome

26 SERIES

26 SERIES, SURFACE MOUNT, BRANCH DEFLECTOR BRACKET



FEATURES

- Surface mounts on two screws at 1.5" centers
- Ground through base
- Popular for use on school and commercial buses
- Heavy duty steel and acrylic construction
- Lens attaches to base with one center screw
- Optional zinc-plated steel guard provides additional protection
- Replaces Signal-Stat 1151/1151A/9251

Part Number	Mount Material	Mount Color
26723	Steel	Chrome
26724	Steel	Chrome

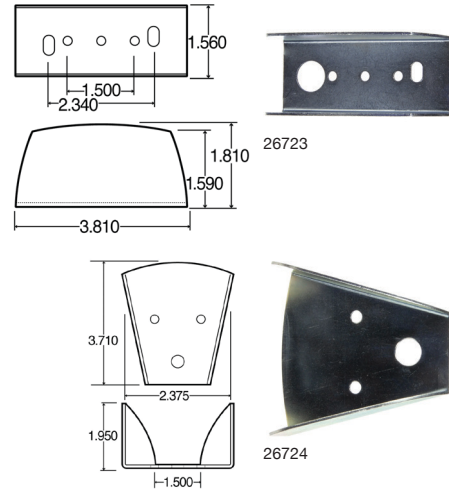

26 SERIES

26 SERIES, SURFACE MOUNT BRACKET



FEATURES

- Designed to enhance appearance of lamps
- Corrosion resistant chrome plating
- Sleek Design
- For use with the following part numbers: 26250R, 26250Y, 26251R, 26251Y, 26270R and 26270Y

Part Number	Mount Material	Mount Color
26002	ABS	Chrome

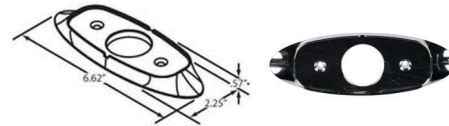

26 SERIES

26 SERIES, SURFACE MOUNT, LICENSE PLATE LAMP BRACKET



FEATURES

- High-impact housing with streamline design
- Mounts on 1-3/4" hole centers
- Replaces Signal-Stat 420W and 423W

Part Number	Mount Material	Mount Color
26380	PC	Gray

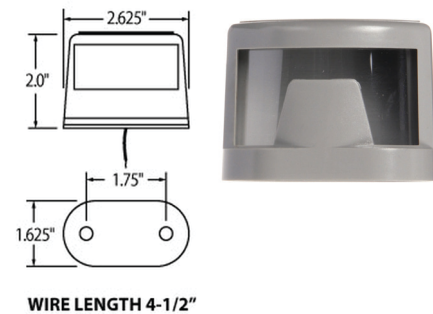

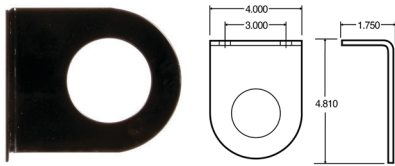

30 SERIES, BRACKET MOUNT, 2 SCREW

FEATURES

- Black epoxy painted heavy steel
- Used for mounting Model 30 grommets
- Replaces Signal-Stat 9397



Part Number	Mount Material	Mount Color
30728	Steel	Black

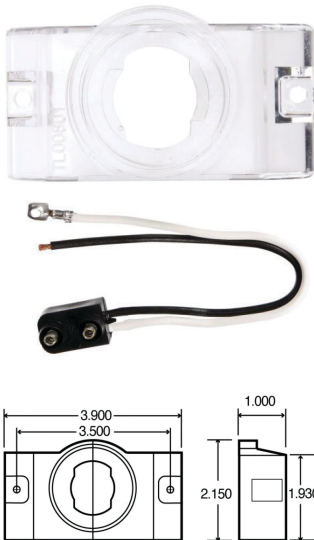

30 SERIES, BRACKET MOUNT, CAM ON/OFF BRACKET

FEATURES

- High-impact plastic mount
- Quick cam-on, cam-off lamp installation
- Suitable for PC requirements on a 45-degree angle using LED or incandescent PC-rated/combination lamps
- Not recommended for use with Signal-Stat LED lamps



Part Number	Mount Material	Mount Color	Kit Includes
00801	PC	Clear	-
30403	PC	Clear	00801 lamp, 94902 plug KIT

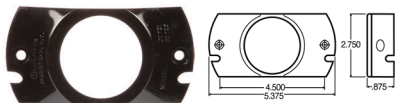

30 SERIES, SURFACE MOUNT BRACKET

FEATURES

- Black epoxy painted heavy steel
- Used for mounting Model 30 grommets
- Replaces Signal-Stat 9397



Part Number	Mount Material	Mount Color
30729	PC	Black

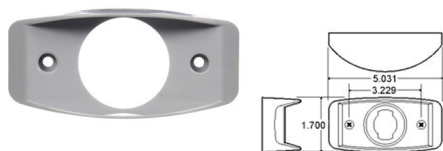

30 SERIES, SURFACE MOUNT BRANCH, DEFLECTOR BRACKET

FEATURES

- High-impact plastic deflector mount
- Inner bracket cams-on, cams-off lamp for quick installation
- Outer bracket provides additional protection
- Not recommended for PC requirements
- Designed for use with lamp #30200R/Y or #30250R/Y



Part Number	Mount Material	Mount Color
30731	ABS	Gray

30 SERIES

30 SERIES, SURFACE MOUNT, CAM ON/OFF BRACKET

FEATURES

- Rust-resistant, stainless-steel mount
- Quick cam-on, cam-off lamp installation
- Meets PC requirements on a 45-degree angle
- Mounts with screws to surface, not included
- Model 30 kits available
- Not recommended for Signal-Stat LED lamps
- Replaces Signal-State 9396

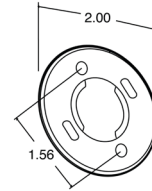

Part Number	Mount Material	Mount Color
30720	Stainless Steel	Silver

30 SERIES

30 SERIES, SURFACE MOUNT BRANCH, DEFLECTOR BRACKET WITH CAM



FEATURES

- High-impact plastic deflector mount
- Inner bracket cams-on, cams-off lamp for quick installation
- Outer bracket provides additional protection
- Not recommended for PC requirements
- Designed for use with lamp #30200R/Y or #30250R/Y

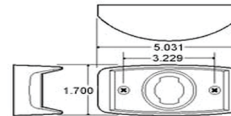

30730



30410

Part Number	Mount Material	Mount Color	Kit Includes
30730	ABS	Gray	-
30410	ABS	Gray	30730 bracket, 30731 bracket 

30 SERIES

30 SERIES, FLANGE COVER



FEATURES

- 30715 flange fits PC lamps only 30708 flange fits P2 lamps only
- Flange cover offers improved theft resistance of all incandescent flanged models and 30251R/Y or 30272R/Y LED model
- Screws required

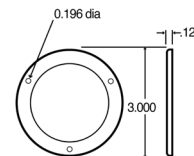

Part Number	Mount Material	Mount Color
30708	Stainless Steel	Silver
30715	Stainless Steel	Silver

30 SERIES, GROMMET COVER

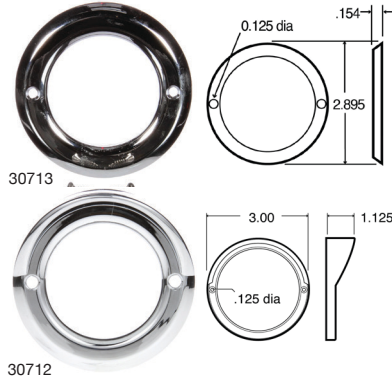

FEATURES

- Grommet cover designed to enhance appearance of lamps
- Screws required



Part Number	Mount Material	Mount Color
30713	Plastic	Chrome
30712	Plastic	Chrome

30 SERIES, SURFACE MOUNT BRACKET

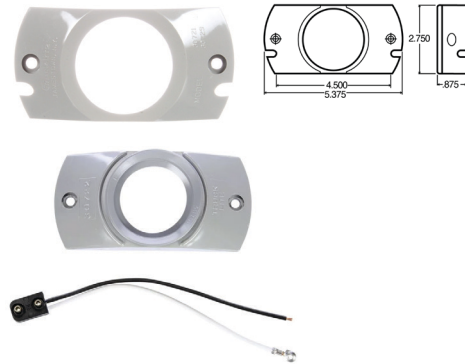

FEATURES

- High-impact plastic mount
- Design allows surface mounting of 2" diameter lamps
- Meets PC requirements on a 45-degree angle using LED or incandescent PC rated/combination lamp
- Replaces Signal-Stat 9395



Part Number	Mount Material	Mount Color	Application	Kit Includes
30721	PC	Gray	—	—
30722	PC	Gray	Not recommended for LED applications	—
30405	PC	Gray	—	30722 bracket, 30701 grommet, 94902 pigtail



30 SERIES, SURFACE MOUNT BRACKET, KIT

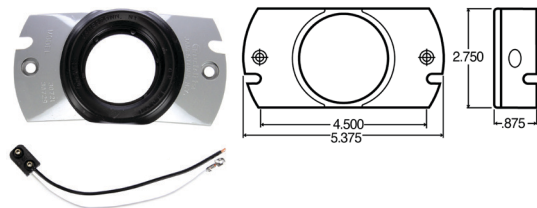

FEATURES

- High-impact plastic mount
- Design allows surface mounting of 2" diameter lamps
- Meets PC requirements on a 45-degree angle using LED or incandescent PC rated/combination lamp
- Replaces Signal-Stat 9395



Part Number	Mount Material	Mount Color	Lamp Connection	Plug Side 1	Plug Side 2	Kit Includes
30404	PC	Gray	PL-10	PL-10	Stripped End/Ring Terminal	94902 plug, 30721 mount, 30700 grommet



33 SERIES ADAPTER FOR 2" & 2.5" MOUNT



FEATURES

- Mounting plates can be installed into any 2" & 2.5" round mounting holes
- Provides an easy way to upgrade incandescent lamps or problematic LED lamps to high quality Truck-Lite 33 Series and 36 Series M/C lamps
- Adapter plates utilize the same mounting holes of standard 2" & 2.5" mounting flanges
- Constructed of impact-resistant polycarbonate for added strength and reliability

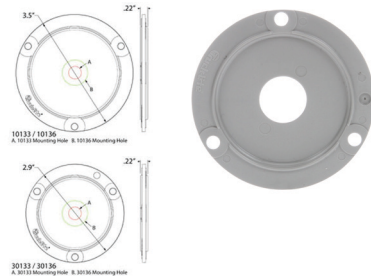

Part Number	Mount Material	Mount Color	Exit Hole	
10133	PC	Gray	-	33 series adapter for 2.5" installation
10136	PC	Gray	-	36 series adapter for 2.5" installation
30133	PC	Gray	0.74in	33 series adapter for 2" installation
30136	PC	Gray	0.38in	36 series adapter for 2" installation

33 SERIES, SURFACE MOUNT BRACKET, 1" X 2", 2 SCREW



FEATURES

- Made specifically for 36 Series Flex-Lite C/M Lamps
- Inner wings assure perfect placement every time
- Outer wings provide extra protection from branches and other objects brushing against the vehicle
- ABS allows for superior weatherability, leading to lower maintenance costs



Part Number	Mount Material	Mount Color
36705	ABS	Gray

33 SERIES, SURFACE MOUNT BRANCH, DEFLECTOR BRACKET



FEATURES

- Enables lamps to be mounted to surface, routing wiring outside vehicle, using mounting holes designed to easily retrofit 19 Series bracket installations
- High-impact plastic construction allowing use of grommet or flange mounts
- Suitable for PC lamp installation, when mounted on a 45-degree angle
- Branch Deflector Mounts (33710, 33712):
- High-impact polycarbonate construction, requires 3/4" hole for installation
- Designed to easily retrofit 19 Series bracket installations
- Suitable for PC-Rated lamps on 45 deg mounting angle

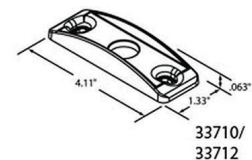

Part Number	Mount Material	Mount Color
33710	PC	White
33712	ABS	Gray

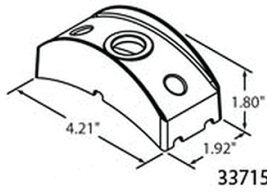

33715

33 SERIES, CORNER MOUNT BRANCH DEFLECTOR BRACKET FOR PC APPLICATION

FEATURES

- Enables lamps to be mounted to surface, routing wiring outside vehicle, using mounting holes designed to easily retrofit 19 Series bracket installations
- High-impact plastic construction allowing use of grommet or flange mounts
- Suitable for PC lamp installation, when mounted on a 45-degree angle
- 33715 curved deflector designed to mount on 4.6" radius corner
- High-impact polycarbonate construction, requires 3/4" hole for installation
- Designed to easily retrofit 19 Series bracket installations
- Suitable for PC-Rated lamps on 45 deg mounting angle



Part Number	Mount Material	Mount Color
33715	ABS	Gray

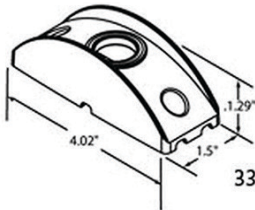

33711

33 SERIES, SURFACE MOUNT BRANCH DEFLECTOR BRACKET

FEATURES

- Enables lamps to be mounted to surface, routing wiring outside vehicle, using mounting holes designed to easily retrofit 19 Series bracket installations
- High-impact plastic construction allowing use of grommet or flange mounts
- Suitable for PC lamp installation when mounted on a 45-degree angle
- Designed to easily retrofit 19 Series bracket installations
- Suitable for PC-Rated lamps on 45-degree mounting angle



Part Number	Mount Material	Mount Color
33711	ABS	Gray

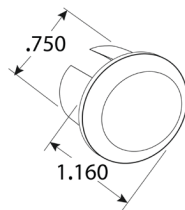

FEATURES

- Flush Mounts, 3/4" diameter lamps to vehicle with snap fit, no screws required
- Sealing grommets secure lamps to vehicle, while assuring a 99.9 percent leak-proof seal
- Chrome-plated flange improves the appearance on vehicle
- Suitable for PC requirements when using LED PC rated/combination lamps
- Security ring can be installed onto flange mount installations to prevent lamps from theft (US Patent 7,572,043)



Part Number	Mount Material	Mount Color
33800	Nylon	Black
33810	Nylon	Chrome

33 SERIES

33 SERIES, RECESSED MOUNT BRACKET



Part Number	Mount Material	Mount Color
33805	ABS	Black

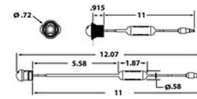

35 SERIES

35 SERIES, SURFACE MOUNT BRANCH DEFLECTOR BRACKET



FEATURES

- Extruded aluminum-armored mounting bracket protects individual lamps from physical damage
- Wiring routed through .65" access hole in base of mount

Part Number	Mount Material	Mount Color
35720	Aluminum	Silver

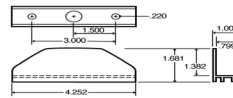

35 SERIES

35 SERIES, M/C ID BAR BRACKET



FEATURES

- Designed to fit applications requiring minimal space
- Slim 1" width is perfect for upper rail mounting
- Draws less current, allowing more power for other vehicle requirements

Part Number	Mount Material	Mount Color	Centers
00815	Aluminum	Silver	6 inch centers
00816	Aluminum	Silver	9 inch centers

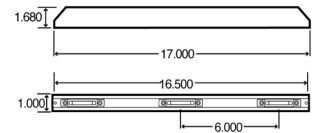

36 SERIES

36 SERIES, LICENSE PLATE LAMP BRACKET



FEATURES

- Side mount options can be mounted without any mounting brackets or fasteners

Part Number	Mount Material	Mount Color
36710	ABS	Gray
36711	ABS	Black

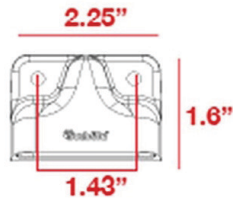

40 SERIES

40 SERIES, BRACKET MOUNT, 2 SCREW



FEATURES

- Black painted reinforced steel
- Designed with 4-1/2" hole for mounting 4" lamps
- Available with or without flange

Part Number	Mount Material	Mount Color
40720	Steel	Black

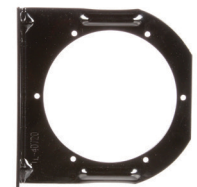
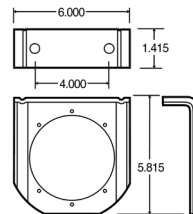

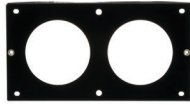

40 SERIES, BRACKET MOUNT, 2 SCREW

FEATURES

- Large outer lens for greater visibility
- Includes slotted bracket for ease of installation and adjustment
- Available with enclosed housing for extra protection



Part Number	Mount Material	Mount Color
40810	Steel	Black

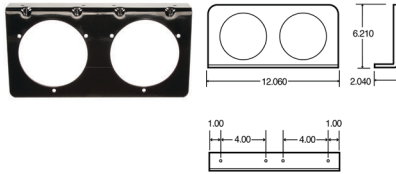

40 SERIES, BRACKET MOUNT, 4 SCREW

FEATURES

- Black epoxy painted steel
- Designed for two 4" lamps in 4 1/2" hole
- Replaces Signal-Stat 9239



Part Number	Mount Material	Mount Color
40715	Steel	Black

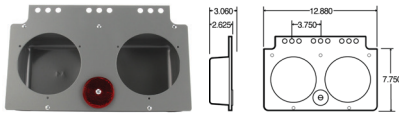

40 SERIES, LIGHT MODULE HOUSING

FEATURES

- Designed as replacement for many OEM trailer applications
- Includes red reflector
- Accepts all 4" grommet or flanged mount lamps
- Replaces Signal-Stat 9524



Part Number	Mount Material	Mount Color
40725	Steel	Gray



40 SERIES, REPLACEMENT TRAILER BOX FLANGE

FEATURES

- Metal mounting flange with high-impact plastic module box
- Optional mounting gasket #97938 available to provide extra seal between module and body



Part Number	Mount Material	Mount Color
40721	Steel	Black

40 SERIES

40 SERIES, FLANGE MOUNT, 5 SCREW



FEATURES

- Black painted reinforced steel
- Designed with 4-1/2" hole for mounting 4" lamps
- Available with or without flange

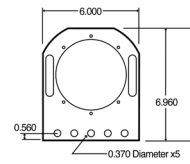

Part Number	Mount Material	Mount Color
40719	Steel	Black

40 SERIES

40 SERIES, SLOTTED-BACK MOUNT, 2 SCREW



FEATURES

- large outer lens for greater visibility
- Includes slotted bracket for ease of installation and adjustment
- Available with enclosed housing for extra protection
- Part #40802 shown above
- Use part numbers 40812 and 40830 for LED versions

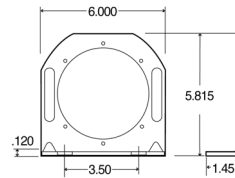

Part Number	Mount Material	Mount Color
40726	Steel	Black



40 SERIES

40 SERIES, FLANGE COVER, 4"



FEATURES

- Designed to enhance the appearance of lamps
- Flange cover offers improved theft resistance
- Three screws required

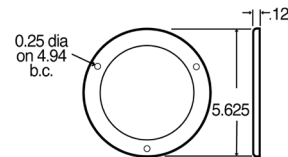

Part Number	Mount Material	Mount Color
44708	Polished Stainless Steel	Silver
44709	Stainless Steel	Black

40 SERIES

40 SERIES, SECURITY FLANGE, 4"



FEATURES

- Helps protect LED lamps from theft, by locking them in place
- Snap-and-go installation greatly reduces installation time, eliminating threaded for screw holes or mounting screws
- Fits Truck-Lite Super 44 6-Diode LED lamps



Part Number	Mount Material	Mount Color	
97334	Stainless Steel	Chrome	7 & 10 gauge applications
97337	Stainless Steel	Chrome	8 gauge applications



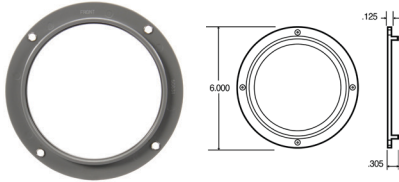

40 SERIES, ADAPTER FLANGE, 4"

FEATURES

- High-impact plastic construction
- Converts 4-3/4" hole to a 4-1/2" hole
- Replaces Signal-Stat 9117



Part Number	Mount Material	Mount Color
50831	ABS	Gray

40 SERIES

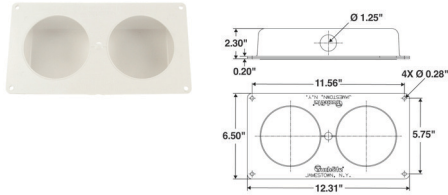

40 SERIES, LIGHT MODULE HOUSING, 4 SCREW

FEATURES

- Metal mounting flange with high-impact plastic module box
- Optional mounting gasket #97938 available to provide extra seal between module and body



Part Number	Mount Material	Mount Color
40722	ABS	White

40 SERIES

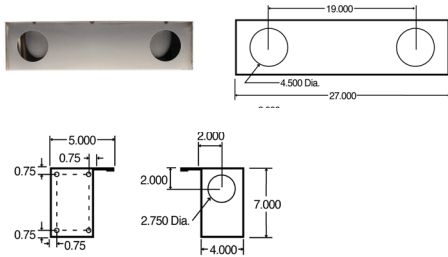

40 SERIES, LIGHT MODULE HOUSING

FEATURES

- Popular on most tanker applications
- Designed for use with two 4" and one 2-1/2" grommet mounted lamps



Part Number	Mount Material	Mount Color	Position
40680	Stainless Steel	Silver	LH
40681	Stainless Steel	Silver	RH

40 SERIES

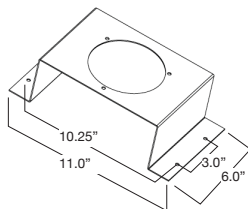

MODEL 44, BRACKET MOUNT, 4" 4 SCREW

FEATURES

- Popular for tanker requirements
- Stainless steel constructions
- Available in flange or standoff versions
- Designed for model 44 products with grommet mount



Part Number	Mount Material	Mount Color
40730	Stainless Steel	Silver

MODEL 44

45 SREIES

45 SERIES, LIGHT ANGLE BRACKET, 2 SCREW BRACKET MOUNT



FEATURES

- Features rust-resistant black epoxy painted reinforced steel
- Mounts lamps using the 45700 grommet|Available with or without flange
- Replaces Signal-Stat 9287

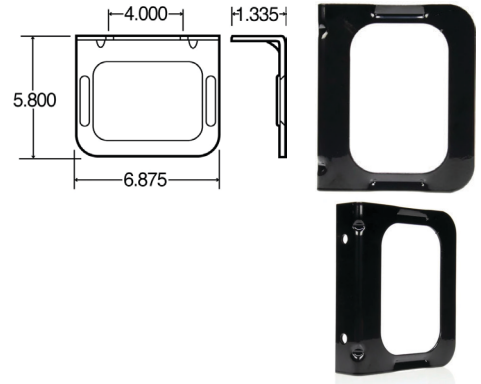

Part Number	Mount Material	Mount Color
45720	Rubber	Black

45 SREIES

45 SERIES, LIGHT MODULE HOUSING, 4 STUD MOUNT



FEATURES

- Rugged thermoplastic rubber housing
- High-impact polypropylene cover
- Unique housing offers shock absorbency and allows lamp replacement without tools



Part Number	Mount Material	Mount Color
45323	Rubber	Black

45 SREIES

45 SERIES, 3 LAMP BRACKET MOUNT, 3"X 5"



FEATURES

- Rust-resistant black epoxy painted reinforced steel
- Mounts lamps using the 45700 grommet
- Available with or without flange
- Replaces Signal-Stat 9287

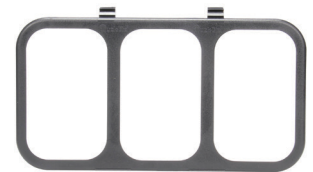

Part Number	Mount Material	Mount Color
45333	Steel	Black

60 SERIES

60 SERIES, MOUNT BRACKET W/CLAMPS, 2"X 6", 2 SCREW



FEATURES

- Designed for 60 series products with grommet or flange mounts
- Available with or without flange

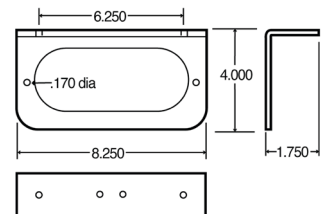
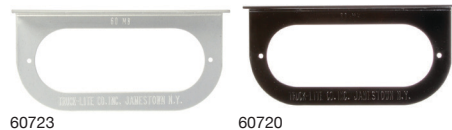

Part Number	Mount Material	Mount Color	Mount
60720	Steel	Black	L Bracket
60722	Steel	Black	Flat
60723	Aluminum	Silver	L Bracket
60724	Aluminum	Silver	Flat

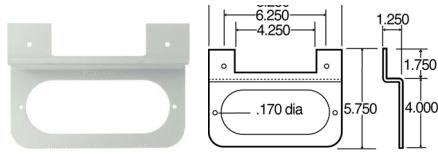

60733

**60 SERIES, MOUNT BRACKET,
2"X 6", 2 SCREW**

FEATURES

- Z configuration is designed for mounting side turn lamps on most trailers
- Notched flange version offers solution for trailer frame interference
- Designed for use with grommet or flange mounted 60 series products



Part Number	Mount Material	Mount Color	
60728	Steel	Gray	Z Configuration
60733	Steel	Gray	Notched Flange

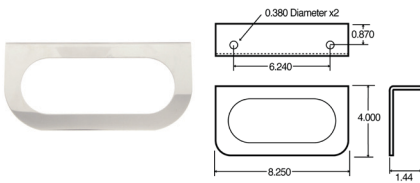

**60 SERIES, MOUNT BRACKET,
2"X 6", 2 SCREW**

FEATURES

- L configuration is designed for mounting side turn lamps on most trailers
- Notched flange version offers solution for trailer frame interference
- Designed for use with grommet or flange mounted 60 series products



Part Number	Mount Material	Mount Color
60730	Stainless Steel	Silver

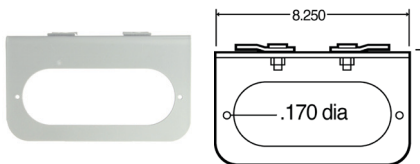

**60 SERIES, MOUNT BRACKET,
WITH CLAMPS, 2"X 6", 2 SCREW**

FEATURES

- Designed for use with grommet or flange mounted 60 series products



Part Number	Mount Material	Mount Color
60729	Stainless Steel	Silver

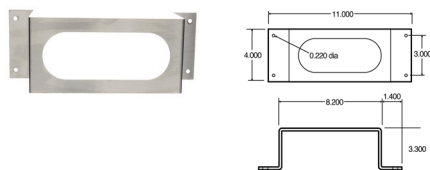

**60 SERIES, SURFACE MOUNT BRACKET,
2"X 6", 4 SCREW**

FEATURES

- Popular for tanker requirements
- Stainless steel constructions
- Available in flange or standoff versions
- Designed for 60 series products with grommet mount
- Replaces Signal-Stat 9292S



Part Number	Mount Material	Mount Color
60731	Stainless Steel	Silver

60 SERIES

60 SERIES, 2 LAMP MOUNT BRACKET, 2"X 6", 2 SCREW



FEATURES

- Bright finished stainless steel for corrosion resistance, added strength and durability
- Designs available for mounting two, three or four lamp systems
- Replaces Signal-Stat 9290S

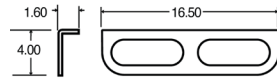

Part Number	Mount Material	Mount Color
60737	Stainless Steel	Chrome

60 SERIES

60 SERIES, M/C ID BAR BRACKET, 2"X 6" 2 SCREW



FEATURES

- Bright finished stainless steel for corrosion resistance, added strength and durability
- Designs available for mounting two, three or four lamp systems
- Replaces Signal-Stat 9290S



Part Number	Mount Material	Mount Color
60738	Stainless Steel	Chrome

60 SERIES

60 SERIES, FLANGE COVER, 2"X 6", 2 SCREW



FEATURES

- Flange cover provides improved theft resistance of LED lamps
- Two screws required

Part Number	Mount Material	Mount Color
60719	Polished Stainless Steel	Chrome
60718	Un-Polished Stainless Steel	Silver

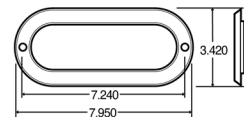

BRACKET MOUNT

BRANCH DEFLECTOR BRACKET, 2 SCREW



- Features
- Use safeguard for extra lamp protection
- Used for 26 series lamps
- Chrome-plated die-cast with mounting holes
- Replaces Truck-Lite 2672 Size: 3-3/8" L x 1-3/16" H x 2-1/8" W

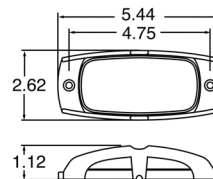

Part Number	Mount Material	Mount Color
9179	Stainless Steel	Silver



AUXILLARY WORK LAMP BRACKET, 2 SCREW

- 9293: For forward and back swivel on auxiliary beams
- For mounting on tubular frame or flat surface on 2" centers
- 9291: Two 1/2" mounting holes
- Size: 3-3/8" L x 1-3/16" H x 2-1/8" W



Part Number	Mount Material	Mount Color
9291	Stainless Steel	Silver

BRACKET MOUNT

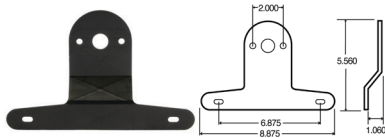

LICENSE PLATE BRACKET, 2 SCREW

FEATURES

- High-impact plastic
- Universal mount



Part Number	Mount Material	Mount Color
80720	Plastic	Black
80722	Plastic	Black

BRACKET MOUNT

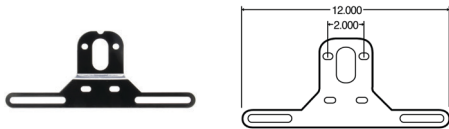

LICENSE PLATE BRACKET, 1" X 2", 2 SCREW

FEATURES

- Designed for universal mounting applications
- Features extra-strong steel construction
- Intended for use with Model 15 license lamps



Part Number	Mount Material	Mount Color
42722	Steel	Black

1 IN X 2 IN



3 STUD BOX LAMP MOUNT, 4"

FEATURES

- GMC# 477332(LH)
- Jeep# SF5758254(LH)
- Dodge# 4114562(RH)
- GMC# 477331(RH)
- Jeep# SF5758255(RH)



Part Number	Mount Material	Mount Color
9288	Steel	Black

4 IN

6 IN

6", WORK LAMP COVER



Part Number	Mount Material	Mount Color
80602	Rubber	Black



3 X 6 IN

3"X6", FOG LAMP COVER



Part Number	Mount Material	Mount Color
80603	Rubber	Black



HARDWARE

TURN SIGNAL SWITCH MOUNTING HARDWARE



Part Number
9190



HARDWARE

WORK LIGHTS MOUNTING HARDWARE



Part Number
92816

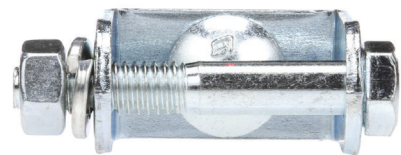

HARDWARE

MARKER CLEARANCE LIGHTS MOUNTING HARDWARE



Part Number
95910



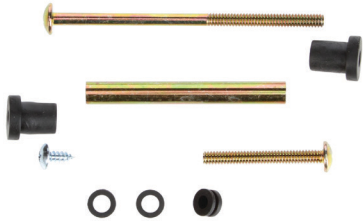

CAB MARKER MOUNTING HARDWARE

Part Number
95911



HARDWARE



PEDESTAL LIGHT MOUNTING HARDWARE

Part Number
97126



HARDWARE

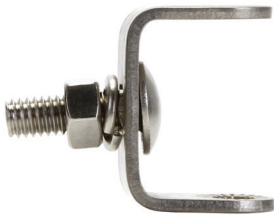

WORK LIGHTS MOUNTING HARDWARE

FEATURES

- Stainless steel mounting hardware
- 5/16"-18 stud Mount

Part Number
97432



HARDWARE

LIGHT MOUNTING GASKETS



Part Number	Compatible Part Numbers	Material
97987	22002R, 22002Y, 22004R, 22004Y, 22006R, 22006Y, 22016Y, 22202R, 22202Y	Foam



Part Number	Compatible Part Numbers	Material
97706	4015, 4016, 4017, 4018, 4023, 4023Y106, 4024, 4024Y106, 4025, 4026, 4027, 4028, 5315Y101, 5316Y101	Foam

GASKET

GASKET



Part Number	Compatible Part Numbers	Material
88-02210	3762, 3763, 3860, 3861, 3862, 3863	Rubber



Part Number	Compatible Part Numbers	Material
88-88130	8945, 8945A	Rubber

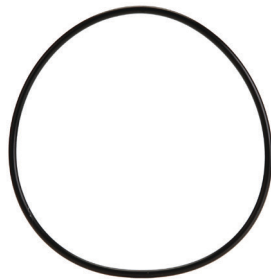

Part Number	Compatible Part Numbers	Material
9120	SS 5800 Series	Rubber



Part Number	Compatible Part Numbers	Material
9180	1204, 1205, 1233, 1235, 1203, 1203A, 1203G, 1233, 1233A	Rubber

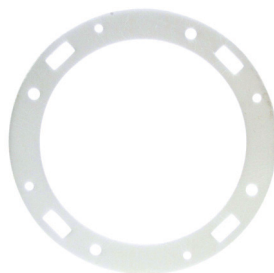

Part Number	Compatible Part Numbers	Material
9520	6503, 6503A, 6506, 90325Y, 90326R, 90326Y, 90327R, 90327Y	Foam

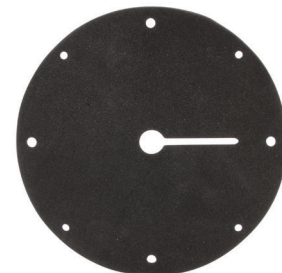

Part Number	Compatible Part Numbers	Material
9521	Arrow T/S Products	Foam

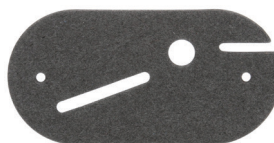

Part Number	Compatible Part Numbers	Material
9522	Shock/Mount Two Bulb	Foam



Part Number	Compatible Part Numbers	Material
9523	Shock/Mount Extended Lens	Foam



Part Number	Compatible Part Numbers	Material
07022	Cab Marker Lamp (25761Y)	Foam

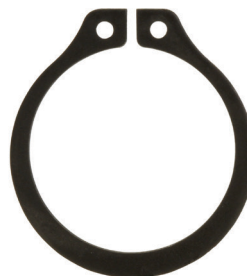

Part Number	Compatible Part Numbers	Material
92808	92676Y, 92677Y	Steel

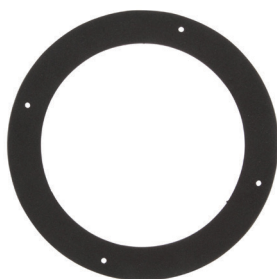

Part Number	Compatible Part Numbers	Material
97031	SS 5800 Series	Rubber

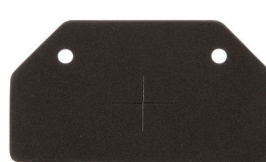

Part Number	Compatible Part Numbers	Material
97032	1204, 1205, 1233, 1235, 1203, 1203A, 1203G, 1233, 1233A	Rubber

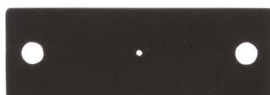

Part Number	Compatible Part Numbers	Material
97034	2150, 2150A, 2152, 2152A, 21001R, 21001Y, 21002R, 21002Y, 21005R, 21005Y, 21051R, 21051Y, 21056R, 21056Y, 21075R, 21075Y, 21080R, 21080Y, 21090Y, 21091Y, 21092Y, 21094Y, 21095Y, 21096Y, 21200R, 21200Y, 21201R, 21201Y, 21205R, 21205Y, 21210Y, 21217R, 21251R, 21251Y, 21253Y, 21256Y, 21275R, 21275Y, 21501R, 21501Y, 21506R, 21506Y, 21507R, 21507Y, 21880R, 21880Y, 21256R	Foam



Part Number	Compatible Part Numbers	Material
97035	35001R, 35001Y, 35080R, 35080Y, 35200R, 35200Y, 35201R, 35201Y, 35880R, 35880Y, 35890R, 35890Y	Foam



Part Number	Compatible Part Numbers	Material
97036	2150, 2150A, 2152, 2152A, 21001R, 21001Y, 21002R, 21002Y, 21005R, 21005Y, 21051R, 21051Y, 21056R, 21056Y, 21075R, 21075Y, 21080R, 21080Y, 21090Y, 21091Y, 21092Y, 21094Y, 21095Y, 21096Y, 21200R, 21200Y, 21201R, 21201Y, 21205R, 21205Y, 21210Y, 21217R, 21251R, 21251Y, 21253Y, 21256Y, 21275R, 21275Y, 21501R, 21501Y, 21506R, 21506Y, 21507R, 21507Y, 21880R, 21880Y, 21256R	Foam



Part Number	Compatible Part Numbers	Material
97038	35001R, 35001R1, 35001R3, 35001Y, 35001Y1, 35001Y3, 35080R, 35080Y, 35200R, 35200R3, 35200Y, 35200Y3, 35201R, 35201Y, 35375R, 35375Y, 35880R, 35880Y, 35890R, 35890Y	Foam

GASKET

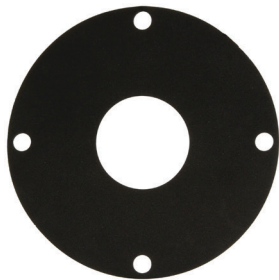

Part Number	Compatible Part Numbers	Material
97039	91241Y, 91242R, 91243Y, 91244R	Foam



Part Number	Compatible Part Numbers	Material
97046	26 Series Lamps	Foam



Part Number	Compatible Part Numbers	Material
97050	19723, 19724, 19736	Foam

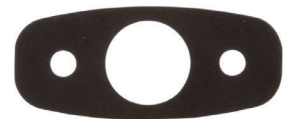

Part Number	Compatible Part Numbers	Material
97073	26250R, 26250Y, 26251R, 26251Y	Foam

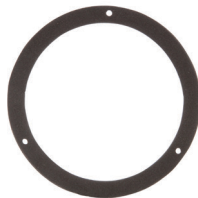

Part Number	Compatible Part Numbers	Material
97079	10051R, 10051R, 10051Y, 10079R, 10079Y, 10089R, 10089Y, 10090R, 10090Y, 10091R, 10091Y, 10092R, 10092Y, 10251R, 10251Y, 10271Y, 10279R, 10288R, 10288Y, 10289R, 10289Y, 10379R, 10379Y, 10389R, 10389Y, 10391R, 10391Y	Foam

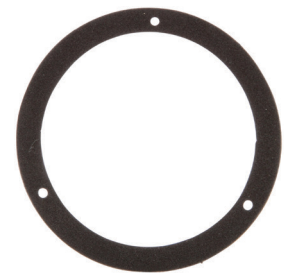

Part Number	Compatible Part Numbers	Material
97080	30221R, 30221Y, 30222R, 30222Y	Foam

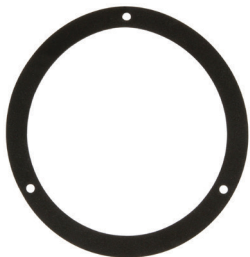

Part Number	Compatible Part Numbers	Material
97093	80334R, 80335R, 80336R, 80342, 80344, 80345, 81300R, 81300Y, 81301R, 81301Y	Foam

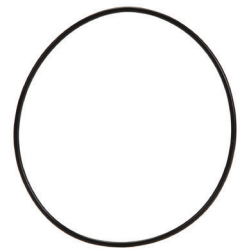

Part Number	Compatible Part Numbers	Material
97094	80334R, 80334R3, 80335R, 80336R, 80342, 80344, 80345, 81300R, 81300Y, 81301R, 81301Y	Foam



Part Number	Compatible Part Numbers	Material
97701	25766R, 25766Y	Foam

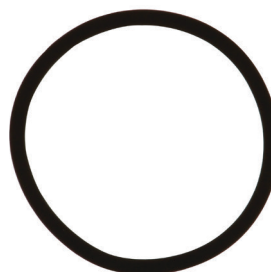

Part Number	Compatible Part Numbers	Material
97905	26760Y	Foam



Part Number	Compatible Part Numbers	Material
97921	12200C, 12200R, 12200Y, 12201R, 12201Y	Foam



Part Number	Compatible Part Numbers	Material
97925	12200C, 12200R, 12200Y, 12201R, 12201Y	Foam



Part Number	Compatible Part Numbers	Material
97921	12200C, 12200R, 12200Y, 12201R, 12201Y	Foam

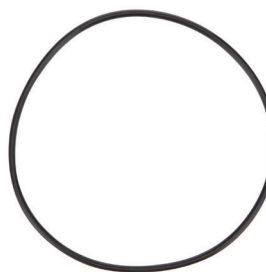

Part Number	Compatible Part Numbers	Material
97933	50800, 50801	Rubber



Part Number	Compatible Part Numbers	Material
97945	80302R, 80302Y, 80304, 80334R, 80335R, 80336R, 80342, 80344, 80345, 81300R, 81300Y, 81301R, 81301Y	Stainless Steel



Part Number	Compatible Part Numbers	Material
97947	26740R, 26741Y	Stainless Steel

HARDWARE

PEDESTAL LIGHTS MOUNTING HARDWARE



Part Number
97126



HARDWARE

PLOW LIGHT AND AUXILIARY HEADLIGHT MOUNT



Part Number
07168

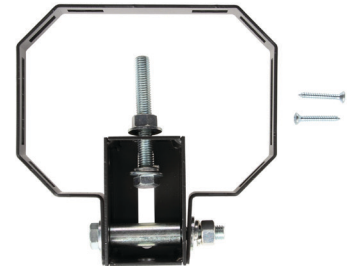

10 SERIES

10 SERIES, 2.5", OPEN BACK



FEATURES | 10700/10713

- Flush mounts 2-1/2" diameter lamps
- Wide groove for panel thickness up to .250"
- Narrow groove for panel thickness up to .125"
- Suitable for PC requirements on a 45-degree angle when using LED or incandescent PC-rated/combination lamps

FEATURES | 10704/10706

- Designed for recess mounting
- Suitable for PC requirements on a 45-degree angle when using LED or incandescent PC-rated/combination lamps
- Adapts to surface thickness up to .125"

FEATURES | 10708

- Designed for edge lighting
- Suitable for PC requirements on a 45-degree angle using all 2-1/2" diameter lamps
- Adapts to surface thickness up to .25

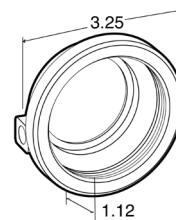

10700/10713



10704/10706

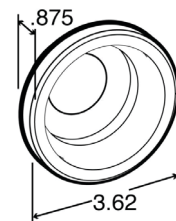

10708

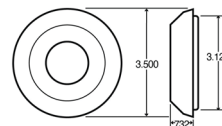

Part Number	Mount Material	Mount Color	Groove	
10700	PVC	Black	Wide	-
10704	PVC	Black	Normal	-
10706	PVC	White	Normal	For 3" Hole
10708	Rubber	Black	Wide	For 3" Hole
10713	PVC	Black	Narrow	

10 SERIES, GROMMET COVERS

Part Number	Mount Material	Mount Color
10719	Plastic	Chrome
10740	Plastic	Chrome

10719 VISOR COVER



10740 GROMMET COVER



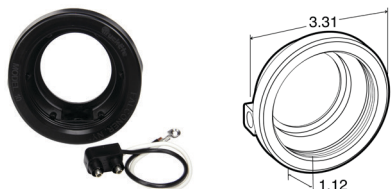

10 SERIES, 2.5", OPEN BACK, KIT



FEATURES

- Flush mounts 2-1/2" diameter lamps
- Wide groove for panel thickness up to .250"
- Narrow groove for panel thickness up to .125"
- Suitable for PC requirements on a 45-degree angle when using LED or incandescent PC-rated/combination lamps
- Closed-back versions recommended for open installation where splash plate is not used
- Replaces Signal-Stat 9119 and 9156

Part Number	Mount Material	Mount Color	Lamp Connection	Plug Side 1	Plug Side 2	Kit Includes
10401	PVC	Black	PL-10	PL-10	Stripped End/Ring Terminal	10700 grommet, 94902 plug
10403	Rubber	Black	PL-10	PL-10	Stripped End/Ring Terminal	10708 grommet, 94902 plug

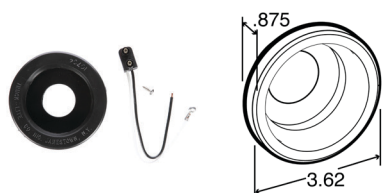

10 SERIES, 2.5", DEEP BACK, KIT



FEATURES

- Designed for recess mounting
- Suitable for PC requirements on a 45-degree angle when using LED or incandescent PC-rated/combination lamps
- Adapts to surface thickness up to .125"
- Replaces Signal-Stat 9121

Part Number	Mount Material	Mount Color	Lamp Connection	Plug Side 1	Plug Side 2	Kit Includes
10404	PVC	Black	PL-10	PL-10	Stripped End/Ring Terminal	10704 grommet, 94902 plug KIT



10 SERIES, 2.5", CLOSED BACK



FEATURES

- Flush mounts 2-1/2" diameter lamps
- Wide groove for panel thickness up to .250"
- Narrow groove for panel thickness up to .125"
- Suitable for PC requirements on a 45-degree angle when using LED or incandescent PC-rated/combination lamps
- Closed-back versions recommended for open installation where splash plate is not used
- Replaces Signal-Stat 9119 and 9156

Part Number	Mount Material	Mount Color	Groove	Lamp Connection	Plug Side 1	Plug Side 2	Kit Includes
10702	PVC	Black	Wide	-	-	-	-
10714	PVC	Black	Narrow	-	-	-	-
10718	Rubber	Black	-	-	-	-	-
10402	PVC	Black	-	PL-10	PL-10	Stripped End/Ring Terminal	10702 Closed Back Grommet , 94902 plug KIT

14 SERIES

**14 SERIES, 2" X 3",
OPEN BACK**



Part Number	Mount Material	Mount Color
14700	PVC	White
14701	PVC	Black

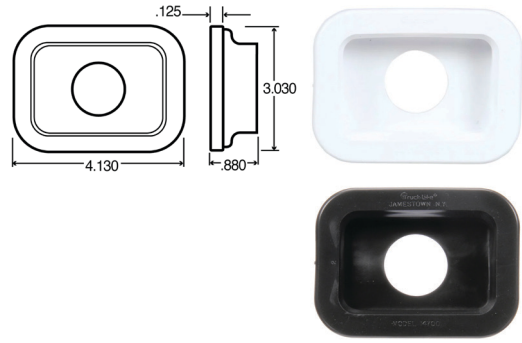

15 SERIES

**15 SERIES, 1" X 2",
OPEN BACK**



FEATURES

- Flush mount vinyl PVC grommet
- Mounts in panel thickness up to .250"
- Suitable for PC requirements on a 45-degree angle with incandescent lamps

Part Number	Mount Material	Mount Color
15702	PVC	Black

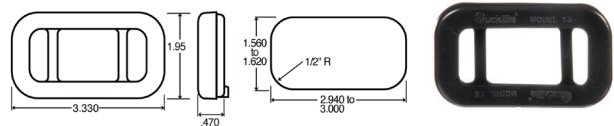

30 SERIES

**30 SERIES, 2",
OPEN BACK**



FEATURES

- Flush mounts 2" diameter lamps
- Wide groove for panel thickness up to .250"
- Suitable for PC requirements when using LED or incandescent PC-rated/combo lamps
- Closed-back versions recommended for open installation where splash plate is not used

Part Number	Mount Material	Mount Color	Groove
30700	PVC	Black	
30701	PVC	Gray	
30706	PVC	White	
30707	PVC	Gray	Wide
30711	Rubber	Black	



**30 SERIES GROMMET
30707 / 30711**

Part Number	Mount Material	Mount Color	Lamp Connection	Plug Side 1	Plug Side 2	Kit Includes
30401	PVC	Black	PL-10	PL-10	Stripped End/Ring Terminal	30700 Grommet, 94902 Plug



**30 SERIES, 2",
CLOSED BACK**



FEATURES

- Flush mounts 2" diameter lamps
- Wide groove for panel thickness up to .250"
- Suitable for PC requirements when using LED or incandescent PC-rated/combination lamps
- Closed-back versions recommended for open installation where splash plate is not used
- Replaces Signal-Stat 9139



Part Number	Compatible Part Numbers	Material	Exit Hole
30702	PVC	Black	0.75 in
30704	PVC	Black	0.5 in

Part Number	Mount Material	Mount Color	Lamp Connection	Plug Side 1	Plug Side 2	Kit Includes
30402	PVC	Black	PL-10	PL-10	Stripped End/Ring Terminal	30702 Closed Back Grommet, 94902 Plug ^(KIT)

**33 SERIES, 0.75",
OPEN BACK**

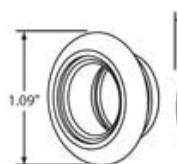

FEATURES

- Flush Mounts, 3/4" diameter lamps to vehicle with snap fit, no screws required
- Sealing grommets secure lamps to vehicle, while assuring a 99.9% leakproof seal
- Suitable for PC requirements when using LED PC-rated/combination lamps
- 33725 is a deep grommet used in license plate lamps



Part Number	Mount Material	Mount Color	Grommet Type	Plate Thickness
33720	Rubber	Black	Sealing Grommet	0.070-0.125
33725	Rubber	Black	Sealing Grommet	0.125-0.250
33705	Rubber	Black	License Grommet	

**33 SERIES, 0.75",
CLOSED BACK**



FEATURES

- Flush Mounts, 3/4" diameter lamps to vehicle with snap fit, no screws required
- Sealing grommets secure lamps to vehicle, while assuring a 99.9% leakproof seal
- Chrome-plated flange improves the appearance on vehicle
- Suitable for PC requirements when using LED PC-rated/combination lamps
- Security ring can be installed onto flange mount installations to prevent lamps from theft (US Patent 7,572,043)



Part Number	Mount Material	Mount Color
33702	PVC	Black

40 SERIES

40 SERIES, 4", OPEN BACK



FEATURES

- Flush mounts 4" diameter lamps in a 4 1/2" hole
- Designed to provide additional shock absorbency to extend lamp life
- TPR grommet designed for extreme environmental applications and eliminates outgassing



Part Number	Mount Material	Mount Color	Lamp Connection	Plug Side 1	Plug Side 2	Kit Includes
40700	PVC	Black	—	—	—	—
40701	PVC	Gray	—	—	—	—
40702	PVC	White	—	—	—	—
40703	PVC	Brown	—	—	—	—
40819	TPR	Black	—	—	—	—
40403	PVC	Black	PL-3	PL-3	Stripped End/Ring Terminal	40700 grommet, 94993 plug KIT

44 SERIES

44 SERIES, 4", GROMMET COVER, OPEN BACK



FEATURES

- Designed to enhance the appearance of lamps
- Flange cover offers improved theft resistance
- Three screws required

Part Number	Mount Material	Mount Color	
44700	Plastic	Chrome	with Visor
44701	Plastic	Chrome	no Visor

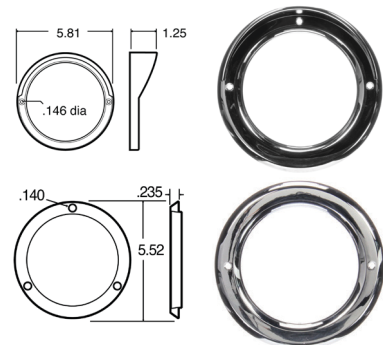

44 SERIES

44 SERIES, 4", GROMMET, SECURITY



FEATURES

- Offers theft resistance by eliminating opportunity to remove lamp from outside of vehicle
- With "Pull-Through" design PVC construction allows lamp to fall back into mounting box upon great impact, reducing chance of damage
- Easily mounts over any Truck-lite Super 44 Series 4" flanged LED lamp

Part Number	Mount Material	Mount Color
44710	PVC	Black

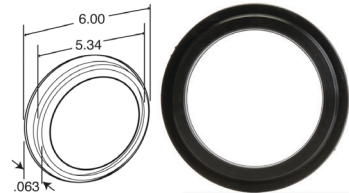

45 SERIES

45 SERIES, 3"X 5", OPEN BACK



FEATURES

- Designed for flush mounting 45 Series lamps
- Standard grommet mounts in plate thickness of .06" to .375
- LLV grommet designed specifically for Model 45 LLV lamps mounted in plate thickness of .09" to .125"
- Replaces Signal-Stat 9175 and 9329

Part Number	Mount Material	Mount Color	Grommet Type
45700	PVC	Black	Standard
45701	PVC	Black	LLV

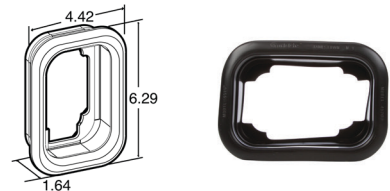

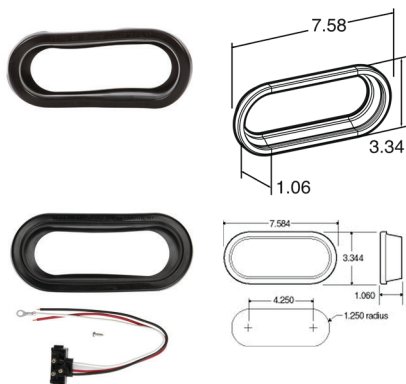

60 SERIES, 2"X 6", OVAL GROMMET OVAL OPEN BACK

FEATURES

- Flush mounts the 60 Series lamps
- Provides lamps with additional shock absorbency to extend lamp life
- TPR grommet designed for extreme environmental applications and eliminates outgassing
- Closed-back recommended for LED products only and protects against corrosion and stone damage



Part Number	Mount Material	Mount Color	Grommet Type	Lamp Connection	Plug Side 1	Plug Side 2	Kit Includes
60700	PVC	Black	—	—	—	—	—
60701	PVC	Black	LLV	—	—	—	—
60708	TPR	Black	—	—	—	—	—
60403	PVC	Black	—	PL-3	PL-3	Stripped End/Ring Terminal	60700 grommet, 94993 plug KIT



60 SERIES, 2"X 6", CLOSED BACK

FEATURES

- Flush mounts the 60 Series lamps.
- Closed-back recommended for LED products only and protects against corrosion and stone damage.



Part Number	Mount Material	Mount Color
60704	PVC	Black

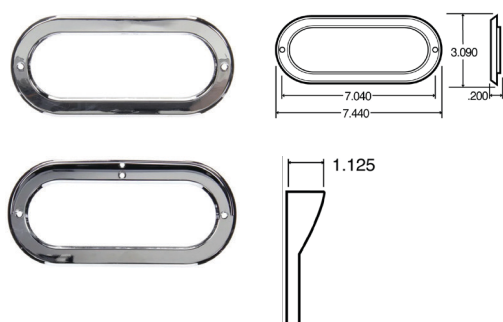

60 SERIES, 2"X 6", GROMMET COVER

FEATURES

- Grommet cover features chrome plated plastics to enhance appearance of lamps
- Two screws required



Part Number	Mount Material	Mount Color	
60703	PVC	Black	
60705	—	—	with Visor

HARNESSES SYSTEMS & WIRING

Category	Page
Plugs	360-375
Sockets	376-377
Strings	378-379
Harness Systems	380-383
	88 SERIES
	Main Cables 384-386
	License Harness 387-388
	S/T/T Harness 388
	Junction Box Adaptor 388
	ABS Harness 389
	ID Harness 389-391
	Marker/Clearance Harness 391
	50 SERIES
	Main Cables 392
	S/T/T Harness 392-394
	ID Harness 394-396
	ABS Harness 396
	Marker/Clearance Harness 396-397
Junction Box	398-399
Heat Shrink Tube	399
Fuses	400
Junction Box Accessories	400-401
Wire Splices	402
Conductor Fittings & Clips	402-403
Nose Boxes	404
Nose Boxes Accessories	405-406
Receptacles	407
Trailer Cords	408
Trailer Connector Cable Plugs	409

HOW TO SELECT SIZE OF ELECTRIC CABLE

Voltage drop is the primary consideration in selecting the proper electrical wire size. The length of wire in a circuit is the major contributing factor to voltage drop. The table below may be used in determining adequate wire gauge sizes for specific lengths of cable when the amperage requirements are known.

Example: A lamp is 38 ft. from the power source and requires 10 amperes. This figure, when rounded upwards to the nearest column heading given in the table, is 40 ft. The wire gauge in the “40-ft. Column” corresponding to 10 amperes is No. 12.

Total length of cable in circuit from battery to most distant lamp

12 Volt System

Amperes (Approx.)	Up To 30 Feet	40 Feet	50 Feet	60 Feet	80 Feet	100 Feet	120 Feet
	Gauge		Gauge	Gauge	Gauge	Gauge	Gauge
1.0	14	14	14	14	14	14	14
2	14	14	14	14	14	14	14
3	14	14	14	14	14	14	12
4	14	14	14	14	14	12	12
5	14	14	14	14	12	12	12
6	14	14	14	14	12	12	10
7	14	14	14	12	12	10	10
8	14	14	12	12	10	10	10
10	14	12	12	12	10	10	8
11	14	12	12	10	10	8	8
12	14	12	12	10	10	8	8
15	12	12	10	10	8	8	8
18	12	10	10	8	8	8	8
20	12	10	10	8	8	8	6
25	12	10	8	8	8	6	6
30	12	10	8	8	8	6	6
35	12	10	8	8	6	6	6

*Recommended minimum wire gauge size for stop light and ground circuits.

- Single trailer (up to 50' length)
- Doubles trailer (2-28' lengths)
- Doubles trailer (2-40' lengths)
- Triples trailer (3-28' lengths)

Stop Light (Red)

- 12 Gauge
- 12 Gauge
- 10 Gauge
- 10 Gauge

Ground (White)

- 10 Gauge
- 10 Gauge
- 8 Gauge
- 8 Gauge

Cable size gauge no. (Copper)	length of wire in feet	Maximum current carrying capacity with 0.5 volt drop	wire resistance ohms (Ω) per foot
20 Ga.	10 Ft.	4.74 Amps	0.01054 Ω /ft.
18 Ga.	10 Ft.	7.53 Amps	0.00663 Ω /ft.
16 Ga.	10 Ft.	11.98 Amps	0.00417 Ω /ft.
14 Ga.	10 Ft.	19.05 Amps	0.00262 Ω /ft.
12 Ga.	10 Ft.	30.30 Amps	0.00165 Ω /ft.
10 Ga.	10 Ft.	48.16 Amps	0.00103 Ω /ft.
8 Ga.	10 Ft.	76.59 Amps	0.00065 Ω /ft.

SAE J560 Standards Conductor Identification

Wire Color	Lamp and Signal Circuits	
Wht	White	Ground return to towing vehicle
Blk	*Black	Clearance, side marker & license plate lamps
Yel	Yellow	Left hand turn signal & hazard signal lamps
Red	Red	Stop lamps and antilock devices
Grn	Green	Right hand turn signal & hazard signal lamps
Brn	*Brown	Tail, clearance, side marker lamps & identification lamps
Blu	Blue	Auxiliary/ABS power

*It is recommended to balance the circuits as practicable.

Note: This table gives you the resistance of wire per foot so with ohms law V=I x R you can calculate voltage drops on any of the above wire gauges at any current level and length. For example, voltage drop in 50 ft. 10 AWG wire with 20 amp load is V=20 amp x (0.00103 Ω /ft.) x 50 ft. = 1.03 volts. Be sure to include both the positive and negative leads when calculating total wire length.

Voltage Drop/Foot/Ampere

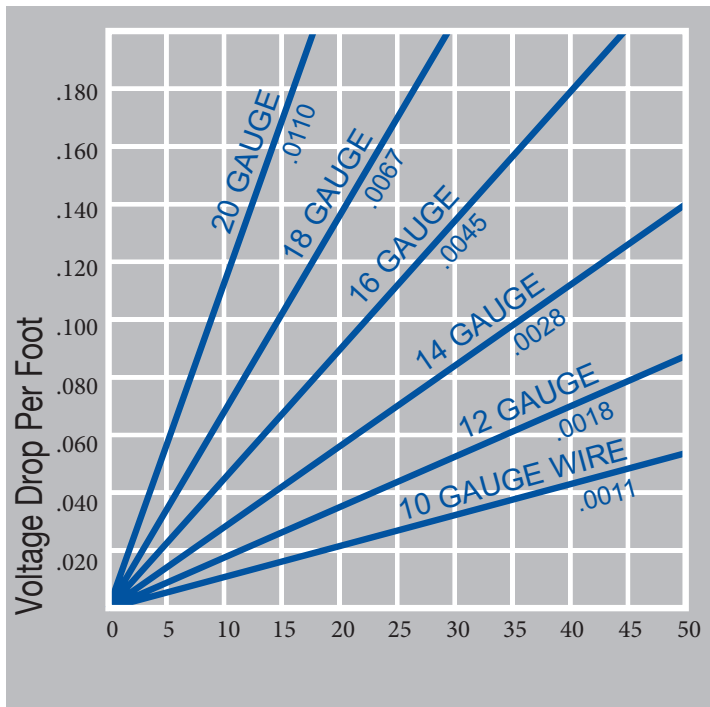

TRAILER WIRING CHARTS
 Informative, easy to read charts on wire gauge sizes, voltage drop/foot/ampere and suggested wire run sizes.

Wire Size

TOTAL FOOTAGE OF WIRE FROM POWER SOURCE TO THE MOST DISTANT ELECTRIC LAMP

24 VOLT SYSTEM (AMPERES)	12 VOLT SYSTEM (AMPERES)	10'	20'	30'	40'	50'	60'	70'	80'	90'	100'
		GAUGE	GAUGE	GAUGE	GAUGE	GAUGE	GAUGE	GAUGE	GAUGE	GAUGE	GAUGE
2.0	1.0	18	18	18	18	18	18	18	18	18	18
3.0	1.5	18	18	18	18	18	18	18	18	18	18
4.0	2.0	18	18	18	18	18	18	18	16	16	16
6.0	3.0	18	18	18	18	18	16	16	16	14	14
8.0	4.0	18	18	18	16	16	16	14	14	14	12
10.0	5.0	18	18	18	16	14	14	14	12	12	12
12.0	6.0	18	18	16	16	14	14	12	12	12	12
14.0	7.0	18	18	16	14	14	12	12	12	10	10
16.0	8.0	18	16	16	14	12	12	12	10	10	10
20.0	10.0	18	16	14	12	12	12	10	10	10	10
22.0	11.0	18	16	14	12	12	10	10	10	10	8
24.0	12.0	18	16	14	12	12	10	10	10	8	8
30.0	15.0	18	14	12	12	10	10	10	8	8	8
36.0	18.0	16	14	12	10	10	8	8	8	8	8
40.0	20.0	16	12	12	10	10	8	8	8	8	6

PLUGS

PLUG DUMMY, .180 RECEPTACLE

	Part Number	Warranty
	97002	1-Year

FEATURES

- For use with Model 19 incandescent lamps
- 16 gauge GPT wire

PLUGS

19 SERIES HOT WIRE

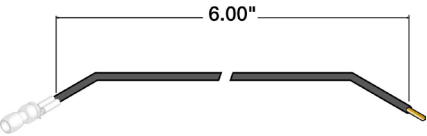
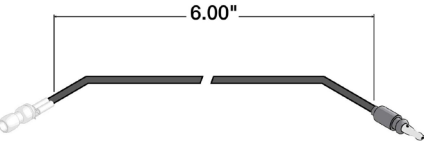
	Part Number	Plug Side 2	Number of Wires	Wire Type	Warranty
	96904	Stripped End	1	GPT	1-Year
	96919	.180 Bullet	1	GPT	1-Year

FEATURES

- For use with Model 19 incandescent lamps
- 16 gauge GPT wire

PLUGS

MODEL 19 PIGTAIL

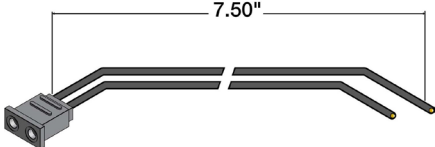
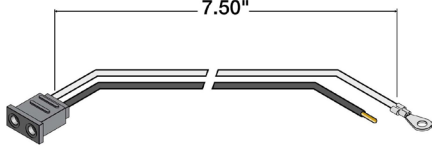
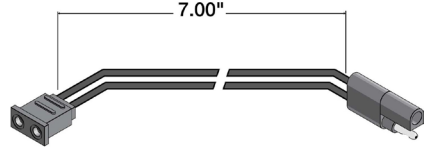
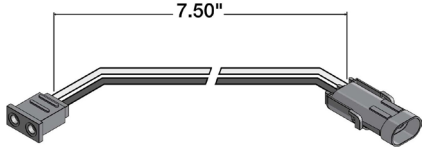

	Part Number	Plug Side 2	Number of Wires	Wire Type	Warranty
	94727	Blunt Cut	2	GPT	1-Year
	94729	Stripped End/ Ring Terminal	2	GPT	1-Year
	94821	Bi-poe Connector	2	GPT	1-Year
	95332 96248	Packard Connector 12010973	2	GPT	1-Year

FEATURES

- For use with Model 19 incandescent lamps
- 16 gauge GPT wire

2 POSITION .180 BULLET

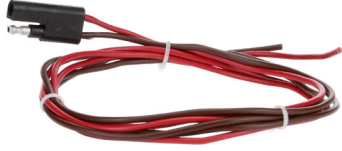
PLUGS

	Part Number	Plug Side 2	Wire Length	Number of Wires	Wire Type	Warranty
	94811	Blunt Cut	50in	2	GPT	1-Year
	94812	Blunt Cut	50in	2	GPT	1-Year
	94813	Blunt Cut	50in	2	GPT	1-Year

2 MALE BLADE TERMINAL

PLUGS

	Part Number	Plug Side 2	Wire Length	Number of Wires	Wire Type	Warranty
	94954	2 Female Blade Terminal	12.06in	2	GPT	1-Year

3 BLADE TERMINAL

PLUGS

	Part Number	Plug Side 2	Wire Length	Number of Wires	Wire Type	Warranty
	9260	Stripped End	14in	3	GPT	1-Year

PLUGS

3 FEMALE BLADE TERMINALS

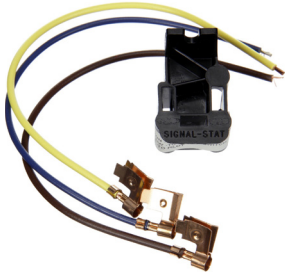
	Part Number	Plug Side 2	Wire Length	Number of Wires	Wire Type	Warranty
	9183	Stripped End	7.5in	3		1-Year

PLUGS

3 PIN FEMALE CONNECTOR 17921

	Part Number	Plug Side 2	Wire Length	Number of Wires	Wire Type	Warranty
	95119	Stripped End	7.25in	2	GPT	1-Year

PLUGS

VOLTAGE REGULATOR

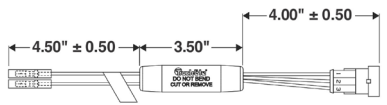
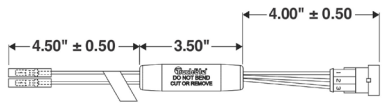
	Part Number	Plug Side 2	Lamp Model	Position	Wire Type	Warranty
	97437	2 .180" Receptacle	35	Upper	GPT	1-Year
	97364	2 .180" Receptacle	33	Upper	GPT	1-Year

PLUGS

VOLTAGE REGULATOR STRAIGHT PL-3 | FIT 'N FORGET S.S

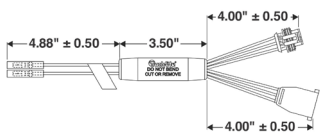
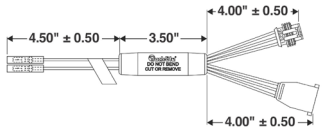
	Part Number	Plug Side 2	Wire Length	Lamp Model	Wire Type	Warranty
	97344	Female .180 Bullet	10.63in	35	GPT	1-Year
	97366	Female .180 Bullet	11.5in	33	GPT	1-Year

UPPER STOP VOLTAGE REGULATOR

PLUGS

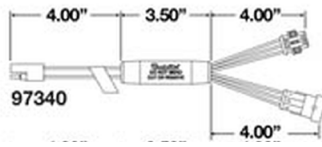
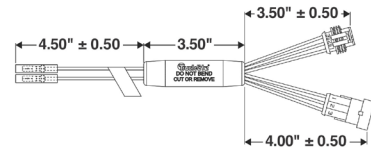
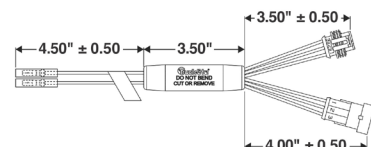
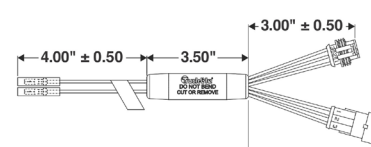
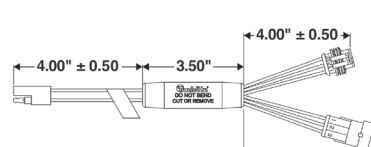
	Part Number	Plug Side 2	Lamp Model	Wire Type	Warranty
	97340	2 Position Plug	35	GPT	1-Year
	97342	.180" Receptacle	35	GPT	1-Year
	97349	.180" Receptacle	10	GPT	1-Year
	97345	.180" Receptacle	33	GPT	1-Year
	97365	2 Position Plugs	33	GPT	1-Year

5 FEMALE BLADE TERMINAL

PLUGS

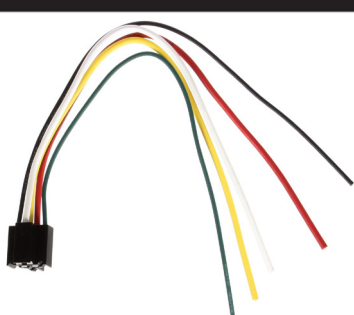
	Part Number	Plug Side 2	Wire Length	Number of Wires	Wire Type	Warranty
	9185	Blunt Cut	12in	5	GPT	1-Year

5 PIN PACKARD CONNECTOR 1208891

PLUGS

	Part Number	Plug Side 2	Number of Wires	Wire Type	Warranty
	9470	Stripped End Ring Terminal	5	GPT	1-Year

DEUTSCH CONNECTOR

PLUGS



	Part Number	Plug Side 2	Number of Wires	Wire Type	Warranty
	94236	Packard Connector 12015793	3	GPT	1-Year

FEMALE .180 BULLET

PLUGS

	Part Number	Plug Side 2	Number of Wires	Wire Type	Warranty	Wire Color
	94923	Stripped End	1	GPT	1-Year	
	95121	Stripped End	1	SXL	1-Year	Black
	95122	Stripped End	1	SXL	1-Year	White
	95123	Stripped End	1	SXL	1-Year	Red/White
	95124	Stripped End	1	SXL	1-Year	Green
	95125	Stripped End	1	GPT	1-Year	Purple
	96253	Packard Connector 12010973	2	GPT	1-Year	

MALE PIN PLUGS

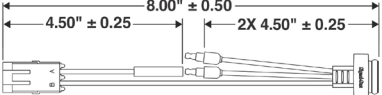
	Part Number	Plug Side 2	Wire Length	Number of Wires	Wire Type	Warranty
 male pin marker/clearance 90 degree	96106	.180 Bullet Ring Terminal	5.9in	2	GPT	1-Year
 180 male pin STT plug	96107	Stripped End Ring Terminal	9.84in	3	GPT	1-Year
 two pin straight/major function	96108	Stripped End Ring Terminal	9.84in	2	GPT	1-Year
 4.50" ± 0.25 8.00" ± 0.50 2X 4.50" ± 0.25	96251	.180 Bullet Female .180 Bullet Packard Connector 12010973	4.5in	4	GPT	1-Year

PLUGS

FEMALE PL-2
SURE SEAL ADAPTER

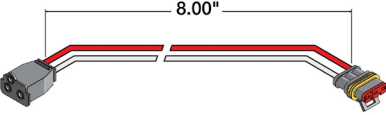
	Part Number	Plug Side 2	Wire Length	Number of Wires	Wire Type	Warranty
 8.00"	94789	Fit 'N Forget S.S.	8in	2	GPT	Lifetime

PLUGS

FEMALE PL-3

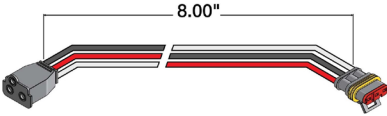
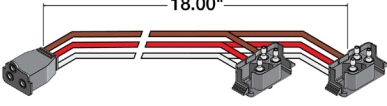
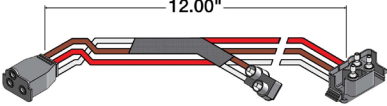
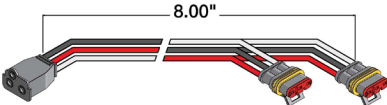
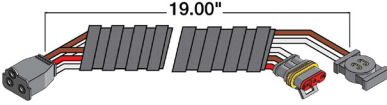
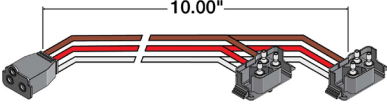
	Part Number	Plug Side 2	Wire Length	Wire Type	Warranty
 8.00"	94706	Fit 'N Forget S.S.	8in	GPT	Lifetime
 18.00"	94750	Right Angle PL-3 / Right Angle PL-3	18in	GPT	1-Year
 12.00"	94751	Right Angle PL-3/ PL-10	12in	GPT	1-Year
 8.00"	94769	2 Fit 'N Forget S.S.	8in	GPT	Lifetime
 19.00"	94770	Fit 'N Forget S.S.	19in	GPT	Lifetime
 10.00"	94932	Right Angle PL-3 / Right Angle PL-3	10in	GPT	1-Year

PLUGS

PLUGS

FEMALE PL-3 | RIGHT ANGLE PL-3

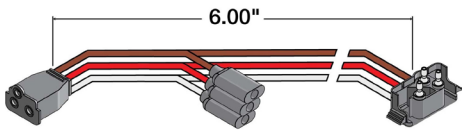
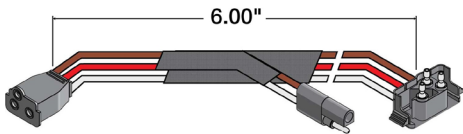
	Part Number	Plug Side 2	Number of Wires	Wire Type	Warranty
	94760	.156" Receptacle	6	GPT	1-Year
	94853	2 Position Plug	5	GPT	1-Year

PLUGS

FEMALE RIGHT ANGLE .180 BULLET TERMINAL

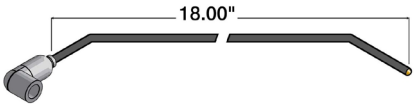
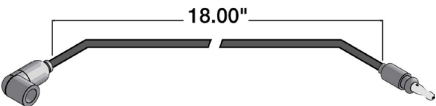
	Part Number	Plug Side 2	Number of Wires	Wire Type	Warranty
	94922	Blunt Cut	1	GPT	1-Year
	95051	.180 Bullet	1	GPT	1-Year



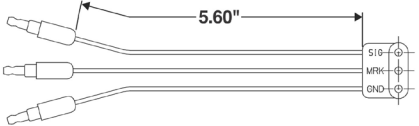
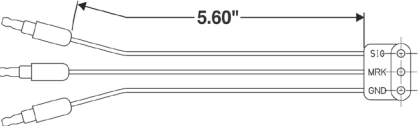

PLUGS

FEMALE TA-1415

	Part Number	Plug Side 2	Number of Wires	Wire Type	Warranty
	9462	.180 Bullet	3	GPT	1-Year
	9463	.180 Bullet Ring Terminal	3	GPT	1-Year

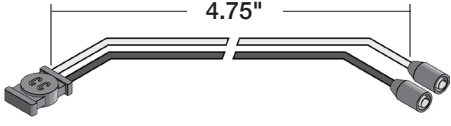
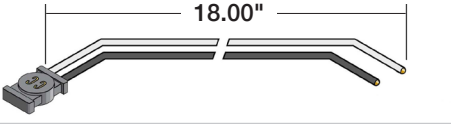
FIT 'N FORGET M/C

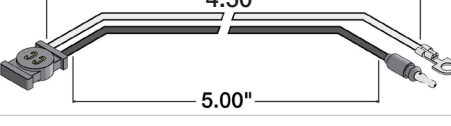
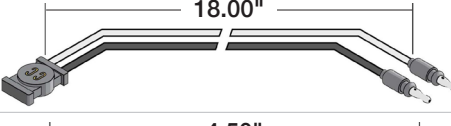
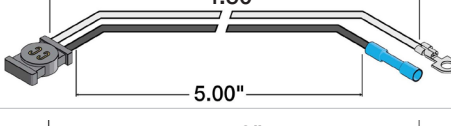
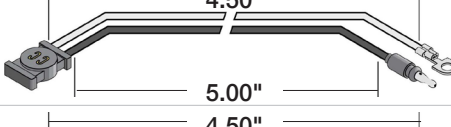
(CONTINUED ON NEXT PAGE)

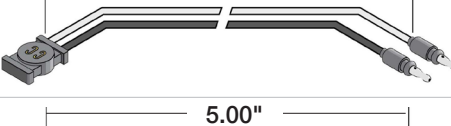
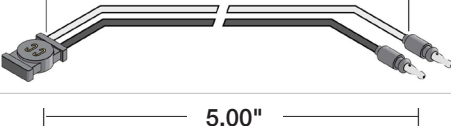
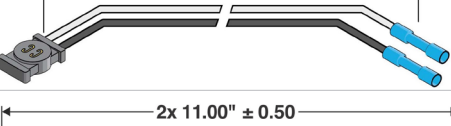
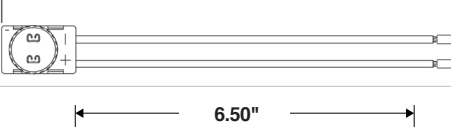
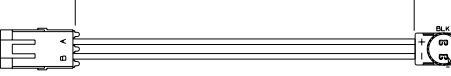
	Part Number	Plug Side 2	Number of Wires	Wire Type	Warranty
	93745	Female PL-10	2	GPT	Lifetime
	94609	Blunt Cut	2	GPT	1-Year
	94624	Packard Connector 12010973	2	GPT	Lifetime
	94718	.180 Bullet Ring Terminal	2	GPT	Lifetime
	94736	.180 Bullet	2	GPT	Lifetime
	94861	Heat Shrink Splices Ring Terminal	2	GPT	Lifetime
	94862	.180 Bullet Ring Terminal	2	GPT	Lifetime
	94888	.156 Bullet Ring Terminal	2	GPT	Lifetime
	95306	.180 Bullet	2	GPT	Lifetime
	97005	.180 Bullet	2	GPT	Lifetime
	97006	Heat Shrink Splices	2	GPT	Lifetime
	94237	Stripped End	2	GPT	1-Year
	96252	Packard Connector 12124582	2	GPT	1-Year

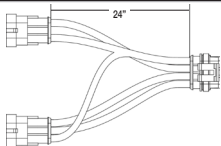
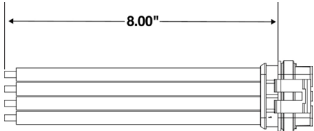

FIT 'N FORGET 4 PIN S.S

	Part Number	Plug Side 2	Wire Length	Number of Wires	Wire Type	Warranty
	94966	LED Super Seal/ 3 Position Connector 282105	24in	4	GPT	1-Year
	94831	Stripped End	8in	4	GPT	1-Year

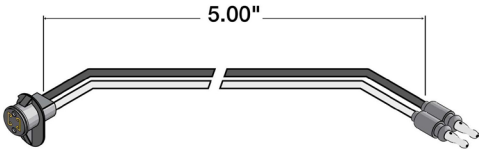
M/C SELF SEAL

	Part Number	Plug Side 2	Wire Length	Number of Wires	Wire Type	Warranty
	95410	.180 Bullet	5in	2	GPT	Lifetime

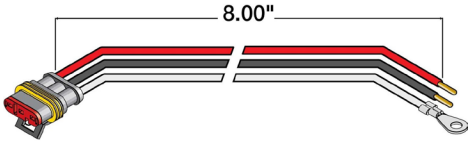
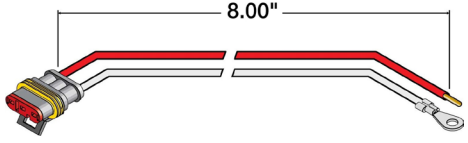
FIT 'N FORGET SURE SEAL

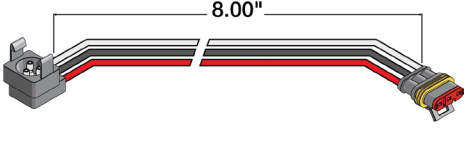
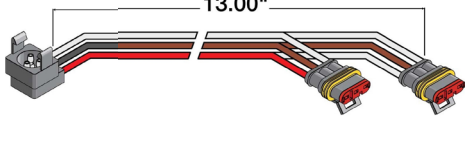
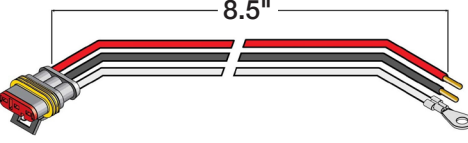
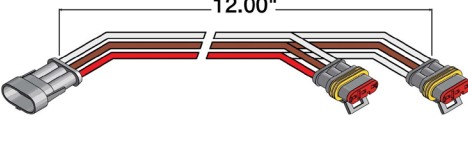
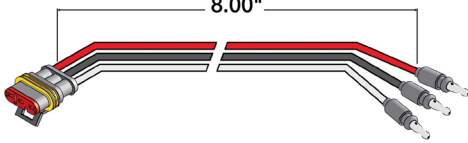
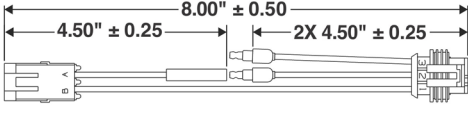
	Part Number	Plug Side 2	Wire Length	Number of Wires	Wire Type	Warranty
	94707	Stripped End Ring Terminal	8in	3	GPT	Lifetime
	94759	Stripped End Ring Terminal	8in	2	GPT	Lifetime
	94766			3	GPT	1-Year
	95001	Male Pin	8in	3	GPT	Lifetime
	95002	Male Pin	13in	6	GPT	Lifetime
	95220	Stripped End Ring Terminal	8.5in	3	GPT	1-Year
	95399	3 Position Connector 282105	12in	6	GPT	Lifetime
	95424	.180 Bullet	8in	3	GPT	Lifetime
	96247	.180 Bullet Female .180 Bullet Packard Connector 12010973	4.5in	4	GPT	1-Year

PLUGS

H4 CONNECTOR

	Part Number	Plug Side 2	Wire Length	Number of Wires	Wire Type	Warranty
	96630	H13 Connector	5in	3	SXL	1-Year
	96830	H13 Connector	4.5in	6	SXL	1-Year

PLUGS

2DI, 9007, H4, 7" ROUND COMPOSITE HEADLAMP ADAPTERS

	Part Number	Plug Side 2	Wire Length	Number of Wires	Wire Type	Warranty
	95400	H4 Connector	4in	3	GPT	1-Year
	95846	3 Blade Terminal	5.5in	3	GPT	1-Year



PLUGS

MALE PIN

	Part Number	Plug Side 2	Wire Length	Number of Wires	Wire Type	Warranty
	94865	Right Angle PL-3 Right Angle PL-3	10in	6	GPT	1-Year
	94897	Right Angle PL-3	5in	3	GPT	1-Year

PACKARD CONNECTOR

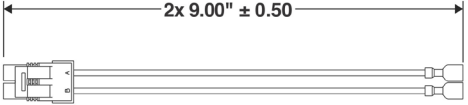
PLUGS

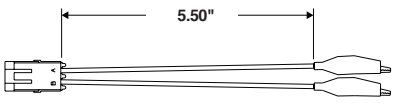
	Part Number	Plug Side 2	Wire Length	Number of Wires	Wire Type	Warranty
	96256	Female Blade Terminal	8in	2	GPT	1-Year
	96254	Packard Connector 12010973	8in	2	GPT	1-Year
	96255	2 Alligator Clip	5.5in	2	GPT	1-Year

RING TERMINAL

PLUGS

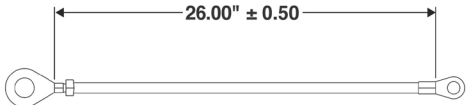
	Part Number	Plug Side 2	Wire Length	Number of Wires	Wire Type	Warranty
	96927	Ring Terminal	26in	1	GPT	1-Year

SUPER 21 PLUG

PLUGS

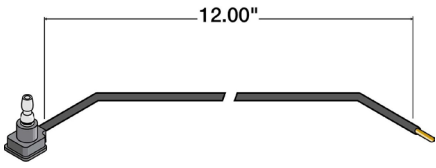
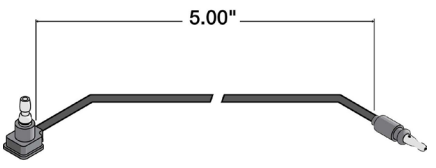
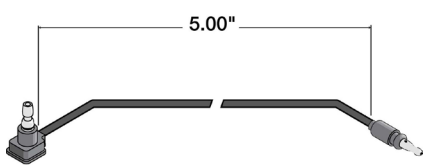
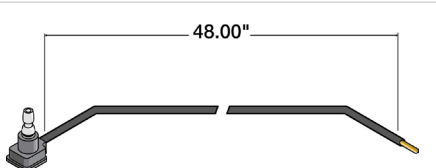
	Part Number	Plug Side 2	Wire Length	Number of Wires	Wire Type	Warranty
	96930	Stripped End	12in	1	GPT	1-Year
	96932	.180 Bullet	5in	1	GPT	1-Year
	96934	.156 Bullet	5in	1	GPT	1-Year
	96936	Stripped End	48in	1	GPT	1-Year

PL-10

	Part Number	Plug Side 2	Wire Length	Number of Wires	Wire Type	Warranty
	94848	Female .156 Bullet	4.5in	2	GPT	1-Year
	94850	.156 Bullet	6.5in	2	GPT	1-Year
	94854	Stripped End Ring Terminal	6in	2	GPT	1-Year
	94902	Stripped End Ring Terminal	7in	2	GPT	1-Year
	94909	Stripped End Ring Terminal	12in	2	GPT	1-Year
	94916	Stripped End Ring Terminal	18in	2	GPT	1-Year
	94919	Stripped End Ring Terminal	6.5in	2	GPT	1-Year
	94920	Stripped End Ground Clip	6in	2	GPT	1-Year
	94972	.180 Bullet	6.5in	2	GPT	1-Year
	96249	Packard Connector 12010973	7in	2	GPT	1-Year

RIGHT ANGLE PL-10

PLUGS

	Part Number	Plug Side 2	Wire Length	Number of Wires	Wire Type	Warranty
	94924	Stripped End Ring Terminal	6.65in	2	GPT	1-Year
	94964	.156 Bullet Ring Terminal	6in	2	GPT	1-Year

RIGHT ANGLE PL-2

PLUGS

	Part Number	Plug Side 2	Number of Wires	Wire Type	Warranty
	94992	Stripped End Ring Terminal	2	GPT	1-Year
	94837	Packard Connector 12020398	2	SXL	1-Year
	94838	Packard Connector 12020398	2	SXL	1-Year
	94851	Packard Connector 12020398	2	SXL	1-Year
	94868	Packard Connector 1500027	2	GPT	1-Year
	94991	Stripped End Ring Terminal	2	GPT	1-Year

RIGHT ANGLE PL-3

PLUGS

	Part Number	Plug Side 2	Number of Wires	Wire Type	Warranty	Bulk Y/N
	94993	Stripped End Ring Terminal	3	GPT	1-Year	No
	94768	Fit 'N Forget S.S.	3	GPT	Lifetime	No
	94802	.156 Bullet Ring Terminal	3	GPT	1-Year	No
	94839	Packard Connector 12015793	3	SXL	1-Year	No
	94840	Packard Connector 12015793	3	SXL	1-Year	No
	94841	Packard Connector 12020398	3	SXL	1-Year	No
	94882	.180 Bullet	3	GPT	1-Year	No
	94931	Stripped End Ring Terminal	3	GPT	1-Year	No

STRAIGHT PL-2

PLUGS

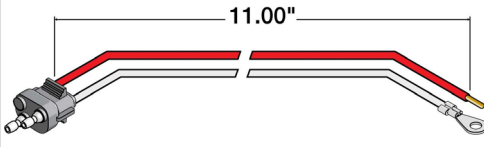
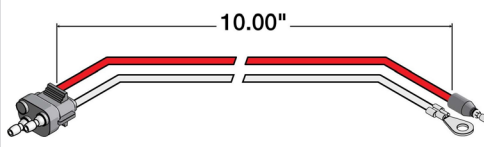
	Part Number	Plug Side 2	Wire Length	Number of Wires	Wire Type	Warranty
	94925	Stripped End Ring Terminal	11in	2	GPT	1-Year
	94961	.156 Bullet Ring Terminal	10in	2	GPT	1-Year

STRAIGHT PL-3

PLUGS

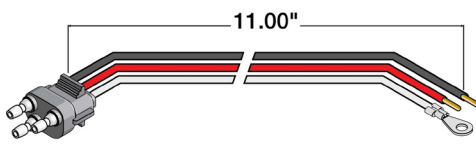
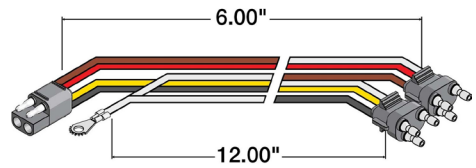
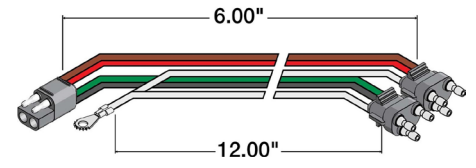
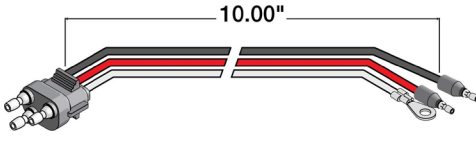
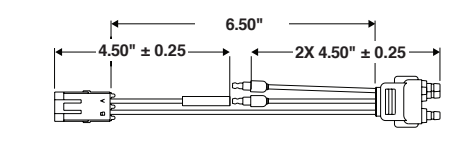
	Part Number	Plug Side 2	Wire Length	Number of Wires	Wire Type	Warranty
	94926	Stripped End Ring Terminal	11in	3	GPT	1-Year
	94948	Ring Terminal Molded Four Position .180	12in	6	GPT	1-Year
	94949	Ring Terminal Molded Four Position .180	12in	6	GPT	1-Year
	94962	.156 Bullet Ring Terminal	10in	3	GPT	1-Year
	96250	.180 Bullet Female .180 Bullet Packard Connector 12010973	6.5in	4	GPT	1-Year

7 CONDUCTOR

BULK CABLE

	Part Number	Plug Side 2	Length	Gauge	Wire Type	Warranty
	52700	Blunt Cut	12000in	8/10/12	GPT	1-Year

1156 & 1157 COMPATIBLE BULB

SOCKET

1156 BULB



FEATURES

- For use with Model 40 bulb replaceable lamps
- 16 gauge GPT wire
- Tin-plated brass terminals
- Bulb # 1156 included

Part Number	Plug Side 2	Length	Compatible Bulbs
94937	Stripped End / Ring Terminal	7.5in	1156
94938	Stripped End / Ring Terminal	7.5in	1157

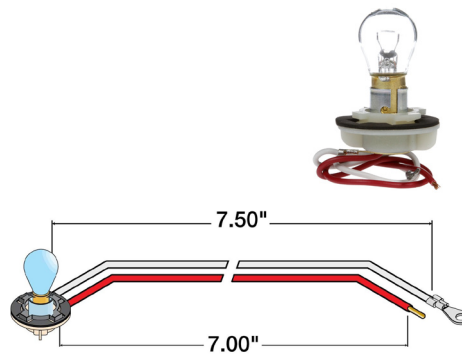

1157/1034 COMPATIBLE BULBS

SOCKET

1157/1034 BULBS



FEATURES

- With "in-line" guide pin for lamps with indexing, bayonet, candelabra type bases (e.g. nos. 1157*, 1034* bulbs)
- Supersedes part #9161

Part Number	Plug Side 2	Length	Compatible Bulbs	Light Type
9101	Stripped End	8in	1157 1034	S/T/T
9105	Stripped End	8in	1157 1034	Pedestal

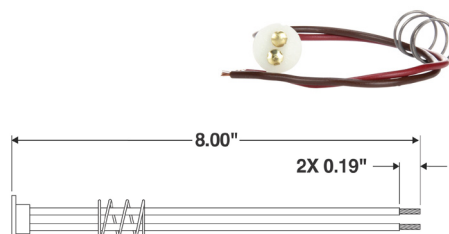

194 COMPATIBLE BULB

SOCKET

194 BULB



FEATURES

- For use with 18300R/Y and 25760 bulb replaceable lamps
- Bulb not included
- 18 gauge wires
- Available with black or white socket

Part Number	Plug Side 2	Length	Compatible Bulbs
94940	Stripped End / Ring Terminal	12in	194

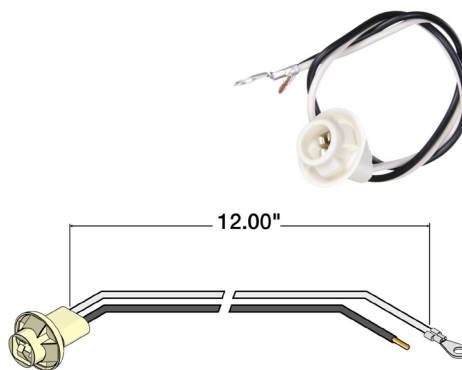

3157 COMPATIBLE BULB

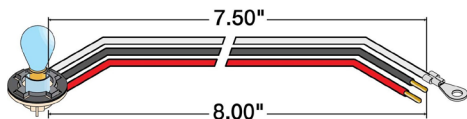

FEATURES

- 9467 - For use with Model 40 bulb replaceable lamps
- 16 gauge GPT wire
- Tin-plated brass terminals
- Bulb #1157 included
- 95407/95415 - For use with Model 60 and Model 91 bulb replaceable lamps
- 16 gauge GPT wire
- Tin-plated brass terminals
- Bulb #3157 included



Part Number	Plug Side 2	Length	Compatible Bulbs
95407	Stripped End / Ring Terminal	9in	3157
95415	Stripped End / Ring Terminal	9in	3157
9467	Packard Connector 12010717	7in	3157

SOCKET

3157 BULBS

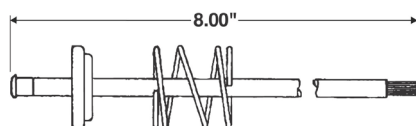
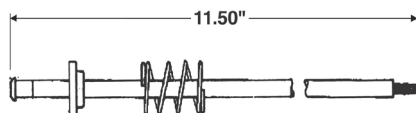

53/57/1895 & 67/1073/1156 COMPATIBLE BULBS

FEATURES

- 9103 - For lamps with miniature bayonet type bases
- 9102, 9160, 9162 - For lamps with bayonet, candelabra type bases
- Supersedes part #9164



Part Number	Plug Side 2	Length	Compatible Bulbs	Light Type
9102	Stripped End	8in	67 1073 1156	Pedestal
9103	Stripped End	11.5in	53 57 1895	
9104	Stripped End	8in	67 1073 1156	
9160	Stripped End	8in	67 1073 1156	Back-Up, Black Wire
9162	Stripped End	8in	67 1073 1156	Pedestal, Black Wire

SOCKET

MULTI BULBS

**MARKER/CLEARANCE,
FIT 'N FORGET**



FEATURES

- Keeps water, salt and other corrosives from LED lamps
- Combine with LED lamps for Lifetime Lighting Warranty eligibility
- 16 gauge GPT wire
- Brass terminals
- For use with bumpers and skirts

	Part Number	Plug Side Two	Center Distance	Number of Wires	Number of Plugs
<p>A= 10.00" B= 48.00"</p>	95460	Stripped End	10in	2	5
<p>A= 10.00" B= 48.00"</p>	95461	Stripped End	10in	2	7
<p>A= 10.00" B= 48.00"</p>	95462	Stripped End	10in	2	9
<p>A= 10.00" B= 48.00"</p>	95463	Stripped End	10in	2	11
<p>A= 4.50" B= 48.00"</p>	95464	Stripped End	4.5in	2	4
<p>A= 4.50" B= 48.00"</p>	95465	Stripped End	4.5in	2	6
<p>A= 4.50" B= 48.00"</p>	95466	Stripped End	4.5in	2	8
<p>A= 4.50" B= 48.00"</p>	95467	Stripped End	4.5in	2	10

STRINGS

MARKER/CLEARANCE

FIT 'N FORGET

MARKER/CLEARANCE,
PL-10

FEATURES



- For use with bumpers and skirts
- 16 gauge GPT wire



	Part Number	Plug Side Two	Number of Wires	Center Distance	Number of Plugs
<p>A=10.00" B=48.00"</p>	95450	Stripped End	2	10in	5
<p>A=10.00" B=48.00"</p>	95451	Stripped End	2	10in	7
<p>A=10.00" B=48.00"</p>	95452	Stripped End	2	10in	9
<p>A=10.00" B=48.00"</p>	95453	Stripped End	2	10in	11
<p>A=4.00" B=48.00"</p>	95454	Stripped End	2	4in	4
<p>A=4.00" B=48.00"</p>	95455	Stripped End	2	4in	6
<p>A=4.00" B=48.00"</p>	95456	Stripped End	2	4in	8
<p>A=4.00" B=48.00"</p>	95457	Stripped End	2	4in	10

ID | LICENSE

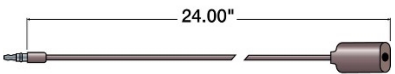
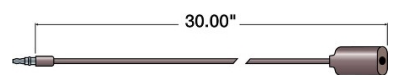
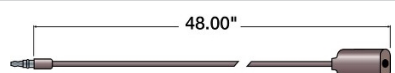
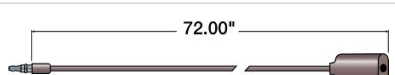
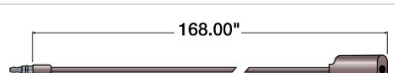
**ID/LICENSE HARNESS FEED
SINGLE RECEPTACLE**

	Part Number	Plug Side 1	Plug Side 2	Wire Color	Wire Gauge	Warranty
	96979	.180 Bullet	Receptacle .180	Black	14	5-Year
	96966	.180 Bullet	Receptacle .180	Black	14	5-Year
	96959	.180 Bullet	Receptacle .180	Black	14	5-Year
	96967	.180 Bullet	Receptacle .180	Black	14	5-Year
	96969	.180 Bullet	Receptacle .180	Black	14	5-Year
	96970	.180 Bullet	Receptacle .180	Black	14	1-Year

ID | LICENSE

**ID/LICENSE HARNESS FEED
DOUBLE RECEPTACLE**

	Part Number	Plug Side 1	Plug Side 2	Wire Color	Wire Gauge	Warranty
	96955	.180 Bullet	Double Receptacle .180	Black	14	5-Year
	97060	.180 Bullet	Double Receptacle .180	Black	14	5-Year
	96960	.180 Bullet	Double Receptacle .180	Black	14	5-Year
	96973	.180 Bullet	Double Receptacle .180	Black	14	5-Year
	96974	.180 Bullet	Double Receptacle .180	Black	14	5-Year
	97061	.180 Bullet	Double Receptacle .180	Black	14	5-Year
	96953	.180 Bullet	Double Receptacle .180	Black	14	5-Year
	96975	.180 Bullet	Double Receptacle .180	Black	14	5-Year
	97062	.180 Bullet	Double Receptacle .180	Black	14	5-Year
	96954	.180 Bullet	Double Receptacle .180	Black	14	5-Year

ID HARNESS, 3 PLUG

ID



3 PLUG

	Part Number	Plug Side 1	Plug Side 2	Wire Color	Wire Gauge	Warranty
	93906	PL-10	Stripped End Ring Terminal	Black, White	14	1-Year
	96955	PL-10	Stripped End Ring Terminal	Black, White	14	1-Year
	97060	PL-10	.180 Bullet Ring Terminal	Black, White	14	1-Year
	93945	PL-10	Stripped End	Black, White	16	1-Year
	96960	Fit 'N Forget M/C	.180 Bullet	Black, White	16	1-Year
	96973	Fit 'N Forget M/C	.180 Recepticle Ring Terminal	Black, White	16	1-Year
	96974	Fit 'N Forget M/C	.180 Bullet	Black, White	16	1-Year
	97061	Fit 'N Forget M/C	Butt Splice	Black, White	16	1-Year
	96953	Fit 'N Forget M/C	.156 Bullet Ring Terminal	Black, White	16	1-Year
	96975	Fit 'N Forget M/C	.180 Bullet Ring Terminal	Black, White	16	1-Year
	97062	Fit 'N Forget M/C	.180 Bullet	Black, White	16	1-Year
	94892	Fit 'N Forget M/C	.156 Bullet Ring Terminal	Black, White	16	1-Year
	94898	Fit 'N Forget M/C	.156 Bullet Ring Terminal	Black, White	16	1-Year

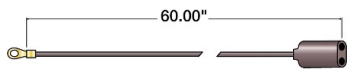
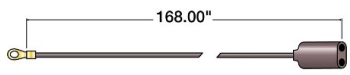
MARKER & CLEARANCE HARNESS FEED

	Part Number	Plug Side 1	Plug Side 2	Wire Color	Wire Gauge	Warranty
	96928	Ring Terminal	Receptacle .180	Black	14	5-Year
	96978	Ring Terminal	Receptacle .180	Black	14	5-Year

MARKER & CLEARANCE|ID HARNESS, 1 PLUG

	Part Number	Plug Side 1	Plug Side 2	Wire Color	Wire Gauge	Length	Warranty
	94781	Fit 'N Forget M/C	Stripped End	Black, White	18	197 in.	5-Year
	94782	Fit 'N Forget M/C	Stripped End	Black, White	18	120 in.	5-Year

MARKER & CLEARANCE|TURN SIGNAL HARNESS, 1 PLUG

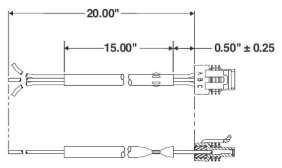
	Part Number	Plug Side 1	Plug Side 2	Wire Color	Wire Gauge	Warranty
	9465	Packard Connector 12162182	Blunt Cut	Black, Red, White	18	1-Year

BACK-UP|LICENCE|STOP/TURN/TAIL HARNESS, 1 PLUG

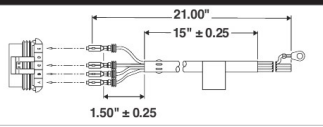
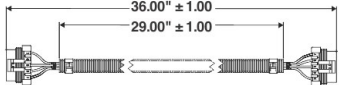
	Part Number	Plug Side 1	Plug Side 2	Wire Color	Wire Gauge	Warranty
	9464	Packard Connector 1265862	Stripped End Ring Terminal	Black, Blue, Red, White	18	1-Year
	9469	Packard Connector 1265862	Packard Connector 1265862	Black, Blue, Red, White	16	5-Year

MARKER/CLEARANCE

MARKER/CLEARANCE

BACK-UP/LICENCE

BACK-UP/LICENCE

**SIGNAL-STAT STOP/TURN/TAIL
CROSS OVER HARNESS**

STOP/TURN/TAIL

	Part Number	Plug Side 1	Plug Side 2	Wire Color	Wire Gauge	Warranty
	9466	Packard Connector 12162183	Ring Terminal Blunt Cut	Black, Blue, Green, Red, White	18	1-Year

SNOW PLOW|ATL HARNESS

SNOW PLOW/ATL

	Part Number	Number of Plugs	Plug Side 1	Plug Side 2	Wire Color	Wire Gauge	Length	Warranty
	80830	2	Meyer Plug Ring Terminal	Blunt Cut	Black, Brown, Blue, Green, Pink, Red, Yellow, White	16	114 in.	1-Year
	80831	2	Meyer Plug Ring Terminal	Blunt Cut	Red, Brown, Blue, Pink, White	16	120 in.	1-Year
	80839	2	Packard Connector 115324197 Ring Terminal	Blunt Cut	Black, Brown, Blue, Green, Pink, Red, Yellow, White	16	114 in.	1-Year
	80930	4	Packard Connector 12010975 08917442 12124580	Ring Terminal Female Blade Terminal	Blue, White, Red, Black, Green, Pink, Yellow, Purple, Brown, Grey, Orange, Pink	16	80 in.	1-Year
	80898	4	Packard Connector 12020827 12020717	Blunt Cut	Black, Blue, Green, Red, Yellow, White	14	94 in.	1-Year
	80976	4			White, Red, Green, Brown, Grey, Purple	16	10 in.	1-Year

88 SERIES

MAIN CABLES

**88 SERIES,
MAIN CABLE, 6 CONDUCTOR**

FEATURES

- Cut length available in 12" increments

	Part Number	Wire Color	Wire Gauge	Warranty
	88601	Black, Brown, Green, Red, Yellow, White	10 12	5-Year

88 SERIES

MAIN CABLES

**88 SERIES,
MAIN CABLE, 7 CONDUCTOR**

FEATURES

- Cut length available in 12" increments

	Part Number	Wire Color	Wire Gauge	Warranty
	88701	Black, Brown, Blue, Green, Red, Yellow, White	10 12	5-Year
	88703	Black, Brown, Blue, Green, Red, Yellow, White	8 10 12	5-Year
	88810	Black, Brown, Blue, Green, Red, Yellow, White	10 12	5-Year
	88820	Black, Brown, Blue, Green, Red, Yellow, White	8 10 12	5-Year

FEATURES

- Cut length available in 12" increments

**88 SERIES,
MAIN CABLE, 7 CONDUCTOR,
INTEGRATED NOSE BOX**

	Part Number	Wire Color	Wire Gauge	Warranty
	89810	Black, Brown, Blue, Green, Red, Yellow, White	10 12	5-Year
	88892	Black, Brown, Blue, Green, Red, Yellow, White	8 10 12	5-Year

FEATURES

- Cut length available in 12" increments

**88 SERIES,
MAIN CABLE, 7 CONDUCTOR,
INTEGRATED NOSE BOX
W/DROPOUTS**

	Part Number	Wire Color	Wire Gauge	Warranty
	88896	Black, Brown, Blue, Green, Red, Yellow, White	8 10 12	5-Year

88 SERIES

MAIN CABLES

88 SERIES

MAIN CABLES

88 SERIES

REAR HARNESS

**88 SERIES,
MAIN CABLE, 7 CONDUCTOR,
W/BREAKOUTS**

FEATURES

- Dimensions "A" indicated standard stocked length harness
- Cut length available in 12" increments

	Part Number	Wire Color	Wire Gauge	Warranty
	88750	Black, Brown, Blue, Green, Red, Yellow, White	10 12	5-Year
	88751	Black, Brown, Blue, Green, Red, Yellow, White	8 10 12	5-Year
	89751	Black, Blue, Brown, Green, Red, Yellow, White	8 10 12	5-Year

88 SERIES

REAR HARNESS

**88 SERIES,
MAIN CABLE, 7 CONDUCTOR,
ADAPTORS**

FEATURES

- Cut length available in 12" increments

	Part Number	Wire Color	Wire Gauge	Warranty
	88905	Black, Brown, Blue, Green, Red, Yellow, White	8 10 12	5-Year
	88962	Black, Brown, Blue, Green, Red, Yellow, White	10 8 20	5-Year
	88900	Black, Brown, Blue, Green, Red, Yellow, White	8 10 12	5-Year

88 SERIES, REAR SILL HARNESS

TURN SIGNAL | LICENSE,
RIGHT ANGLE PL-3 / .180" RECEPTACLE

88 SERIES

S/T/T HARNESS

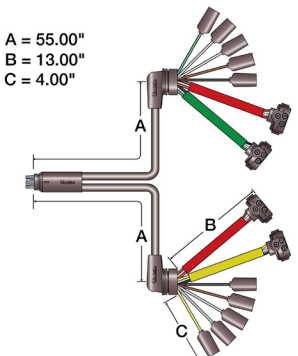
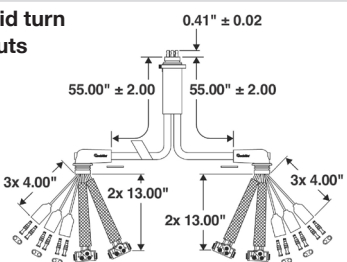
	Part Number	Wire Color	Wire Gauge	Position	Warranty
 <p>A = 55.00" B = 13.00" C = 4.00"</p>	88910	Black, Brown, Green, Red, Yellow, White	14	Rear	5 Year
<p>w/o mid turn dropouts</p>  <p>0.41" ± 0.02 55.00" ± 2.00 55.00" ± 2.00 2x 13.00" 3x 4.00" 2x 13.00" 3x 4.00"</p>	88915	Black, Brown, Green, Red, Yellow, White	14	Rear	5 Year



88 SERIES, REAR SILL HARNESS

TURN SIGNAL | LICENSE,
FIT 'N FORGET / .180" RECEPTACLE

88 SERIES

S/T/T HARNESS

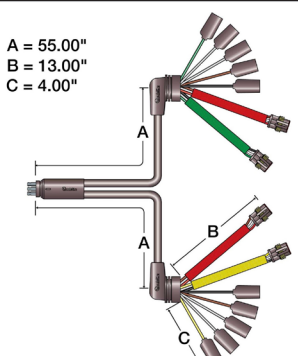
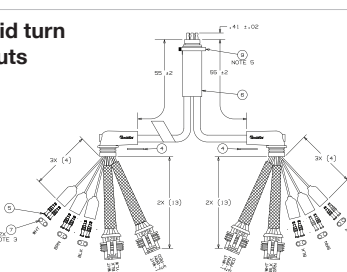
	Part Number	Wire Color	Wire Gauge	Position	Warranty
 <p>A = 55.00" B = 13.00" C = 4.00"</p>	88930	Black, Brown, Green, Red, Yellow, White	14	Rear	5 Year
<p>w/o mid turn dropouts</p>  <p>0.41" ± 0.02 55.00" ± 2.00 55.00" ± 2.00 2x 13.00" 3x 4.00" 2x 13.00" 3x 4.00"</p>	88932	Black, Brown, Green, Red, Yellow, White	14	Rear	5 Year

88 SERIES

S/T/T HARNESS

AUX / ABS

88 SERIES, REAR SILL HARNESS

STOP/TURN/TAIL | LICENSE

W/ABS RIGHT ANGLE PL-3 / .180" RECEPTACLE

	Part Number	Wire Color	Wire Gauge	Position	Warranty
<p>A = 55.00" B = 13.00" C = 4.00" D = 10.00"</p>	88911	Black, Blue, Brown, Green, Red, Yellow, White	14	Rear	5 Year

88 SERIES

S/T/T HARNESS

AUX / ABS

88 SERIES, REAR SILL HARNESS

STOP/TURN/TAIL | LICENSE

W/ABS FIT 'N FORGET / .180" RECEPTACLE



	Part Number	Wire Color	Wire Gauge	Position	Warranty
<p>A = 55.00" B = 13.00" C = 4.00" D = 10.00"</p>	88931	Black, Blue, Brown, Green, Red, Yellow, White	14	Rear	5 Year

88 SERIES

J. BOX ADAP.

88 SERIES, JUNCTION BOX ADAPTOR

	Part Number	Number of Plugs	Wire Color	Wire Gauge	Length	Position	Warranty
	88824	1	Black, Brown, Blue, Green, Red, Yellow, White	14	17in	Upper	1 Year

**88 SERIES,
ABS HARNESS**

	Part Number	Wire Color	Wire Gauge	Warranty
	88100	Blue, Red, White	12	5 Year
	88902	Black, Brown, Blue, Green, Red, Yellow, White	8 10 12	5 Year

88 SERIES

ABS HARNESS

**88 SERIES,
LICENSE HARNESS**

	Part Number	Wire Color	Wire Gauge	Length	Warranty
	88357	Black, White	14	36in	5 Year

88 SERIES

LICENSE HARNESS

**88 SERIES,
ID/LICENSE HARNESS**

FEATURES

- A range of cut length harnesses are available in 12" increments on "B" dimension

	Part Number	Number of Plugs	Wire Color	Wire Gauge	Position	Warranty
<p>A = 4.00" B = 60.00" C = 6.00" D = 15.00" E = 20.00"</p>	88308	4	Brown, White	14	Lower	5 Year
<p>A = 4.00" B = 60.00" C = 6.00" D = 14.25" E = 19.50"</p>	88338	4	Black, White	14	Lower	5 Year

88 SERIES

ID HARNESS

**88 SERIES,
ID HARNESS, REAR**

	Part Number	Number of Plugs	Wire Color	Wire Gauge	Position	Warranty
	95809	3	Brown, White	14	Lower	5 Year

**88 SERIES,
ID HARNESS, LOWER**

FEATURES

- A range of cut length harnesses are available in 12" increments on "B" dimension

	Part Number	Number of Plugs	Wire Color	Wire Gauge	Position	Warranty
<p>A = 4.00" B = 60.00" C = 6.00" D = 15.00"</p>	88300	3	Brown, White	14	Lower	5 Year
<p>A = 4.00" B = 60.00" C = 6.00" D = 8.25"</p>	88367	3	Black, White	14	Lower	5 Year
<p>A = 4.00" B = 192.00" C = 6.00" D = 8.25"</p>	88368	3	Black, White	14	Lower	5 Year
<p>A = 4.00" B = 192.00" C = 6.00" D = 14.25"</p>	88372	3	Black, White	14	Lower	5 Year

88 SERIES

ID HARNESS

88 SERIES

ID HARNESS

**88 SERIES,
ID HARNESS, UPPER**

	Part Number	Number of Plugs	Wire Color	Wire Gauge	Length	Position	Warranty
	88301	3	Brown, White	14	188in	Upper	5 Year
	88358	4	Black, White	14	207.63in	Upper	1 Year
	95879	5	Black, White	14	265in	Upper	5 Year

FEATURES

- A range of cut length harnesses are available in 12" increments

**88 SERIES,
MARKER CLEARANCE HARNESS**

	Part Number	Number of Plugs	Wire Color	Wire Gauge	Warranty
	88303	1	Brown, White	14	5 Year
	88307	1	Brown, White	14	5 Year
	88342	2	Black, White	14	5 Year
	88373	1	Brown, White	14	5 Year
	88385	1	Brown, White	14	5 Year
	88377	1	Black, White	16	5 Year
	87357	1	Black White	14	5-Year
	87358	1	Brown White	14	5-Year
	88401	2	Black White	14	5-Year

50 SERIES

MAIN CABLES

**50 SERIES,
MAIN CABLE, 6|7 CONDUCTOR**

FEATURES

- A range of cut length harnesses are available in 12” increments

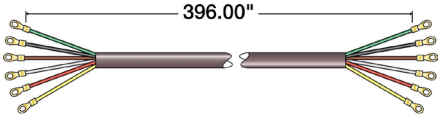
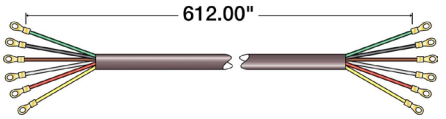
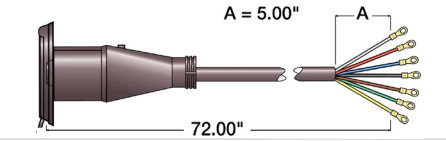
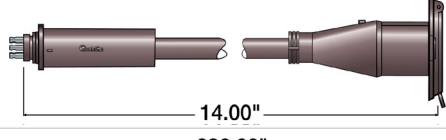
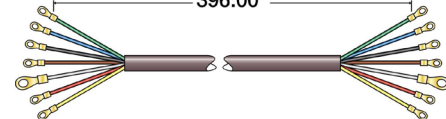
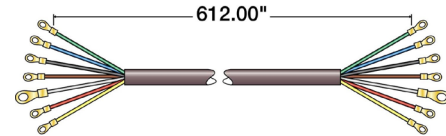
	Part Number	Conductors	Wire Color	Wire Gauge	Warranty
	50133	6	Black, Brown, Green, Red, Yellow, White	10 12	5-Year
	50151	6	Black, Brown, Green, Red, Yellow, White	10 12	5-Year
	50776	7	Black, Brown, Blue, Red, White, Yellow	8 10 12	
	50969	7	Black, Brown, Blue, Green, Red, Yellow, White	8 10 12	
	52733	7	Black, Brown, Blue, Green, Red, Yellow, White	8 10 12	
	52751	7	Black, Brown, Blue, Green, Red, Yellow, White	8 10 12	



50 SERIES

M/C | S/T/T HARNESS

**50 SERIES,
MARKER/CLEARANCE |
STOP/TURN/TAIL HARNESS**

FEATURES

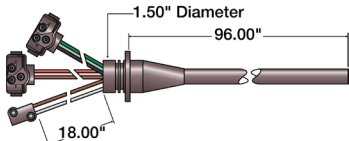
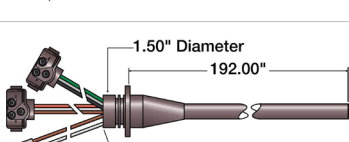
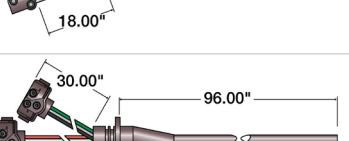
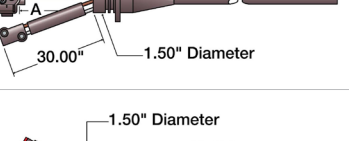
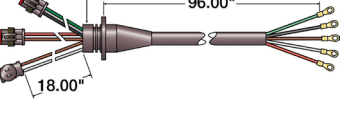
- A range of cut length harnesses are available in 12” increments

	Part Number	Number of Plugs	Wire Color	Wire Gauge	Position	Warranty
	50208	3	Black, Brown, Green, Red, White	14	Right Hand Side	5-Year
	50209	3	Black, Brown, Red, Yellow, White	14	Left Hand Side	5-Year
	50210	3	Black, Brown, Green, Red, White	14	Right Hand Side	5-Year
	50211	3	Black, Brown, Yellow, Red, White	14	Left Hand Side	5-Year
	50230	3	Black, Brown, Green, Red, White	14	Right Hand Side	5-Year
	50231	3	Black, Brown, Yellow, Red, White	14	Left Hand Side	5-Year
	50242	3	Black, Brown, Green, Red, White	16	Right Hand Side	5-Year
	50243	3	Black, Brown, Yellow, Red, White	16	Left Hand Side	5-Year

**50 SERIES,
STOP/TURN/TAIL HARNESSES**

FEATURES

- A range of cut length harnesses are available in 12" increments

	Part Number	Number of Plugs	Wire Color	Wire Gauge	Position	Warranty
	50200	2	Black, Brown, Green, Red, White	14	Right Hand	5-Year
	50201	2	Black, Brown, Yellow, Red, White	14	Left Hand	5-Year
	50202	2	Black, Brown, Green, Red, White	14	Right Hand	5-Year
	50203	2	Black, Brown, Yellow, Red, White	14	Left Hand	5-Year
	50240	2	Black, Brown, Green, Red, White	16	Right Hand	5-Year
	50241	2	Black, Brown, Yellow, Red, White	16	Left Hand	5-Year
	50282	2	Black, Brown, Yellow, Red, White	16	Right Hand Side	1-Year
	50283	2	Black, Brown, Yellow, Red, White	16	Left Hand Side	1-Year
	50325	1	Black, Red, White	14		5-Year
	50338	1	Black, Red, White	14		5-Year
	51270	3	Black, Brown, Green, Red, White	16	Right Hand	5-Year
	51271	3	Black, Brown, Yellow, Red, White	16	Left Hand	5-Year
	51325	1	Black, Red, White	14		5-Year

**50 SERIES,
STOP/TURN/TAIL , 3 PLUG**

FEATURES

- A range of cut length harnesses are available in 12" increments

	Part Number	Number of Plugs	Wire Color	Wire Gauge	Position	Warranty
	50204	3	Black, Brown, Green, Red, White	14	Right Hand	5-Year
	50205	3	Black, Brown, Red, Yellow, White	14	Left Hand	5-Year
	50250	3	Black, Brown, Green, Red, White	14	Right Hand	5-Year
	50251	3	Black, Brown, Yellow, Red, White	14	Left Hand	5-Year

**50 SERIES,
TURN/TAIL HARNESS**

FEATURES

- A range of cut length harnesses are available in 12” increments

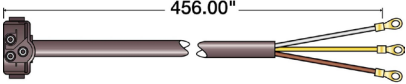
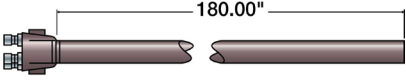
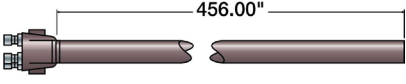
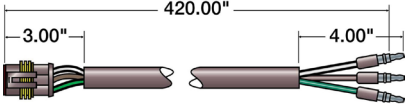
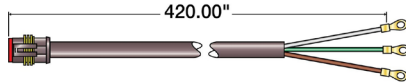
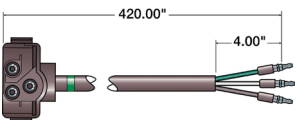
	Part Number	Number of Plugs	Wire Color	Wire Gauge	Position	Warranty
	50266	1	White, Green, Brown	14	Right Hand Side	5-Year
	50267	1	White, Yellow, Brown	14	Left Hand Side	5-Year
	50342	1	White, Green, Brown	14	Right Hand Side	5-Year
	50343	1	White, Yellow, Brown	14	Left Hand Side	5-Year
	50344	1	Black, Green, White	14	Right Hand Side	5-Year
	50345	1	Black, Yellow, White	14	Left Hand Side	5-Year
	51342	1	Brown, Green, White	16	Right Hand Side	5-Year
	51343	1	Brown, Yellow, White	16	Left Hand Side	5-Year
	51344	1	Brown, Green, White	14	Right Hand Side	5-Year
	51345	1	Brown, Yellow, White	14	Left Hand Side	5-Year
	51355	1	Brown, Yellow, White	14	Left Hand Side	5-Year
	51356	1	Brown, Green, White	14	Right Hand Side	5-Year

**50 SERIES,
5 PLUG ID HARNESS | MARKER/CLEARANCE**

- Standard length shown between blunt cut and end seal on diagram

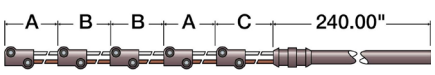
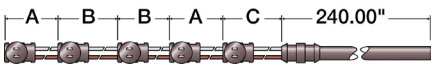
	Part Number	Number of Plugs	Wire Color	Wire Gauge	Position	Warranty
<p>A = 20.00" B = 15.00" C = 6.00"</p> 	50302	5	Brown White	14	Upper	5-Year
<p>A = 50.00" B = 10.00" C = 6.00"</p> 	50388	5	Brown White	14		5-Year

50 SERIES

TURN/TAIL HARNESS

50 SERIES

5 PLUG ID HARNESS W/ M/C

**50 SERIES,
ID HARNASS**

FEATURES

- A range of cut length harnesses are available in 12" increments

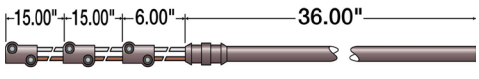
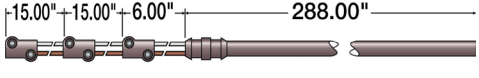
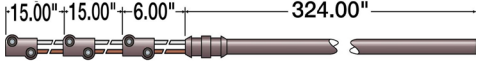
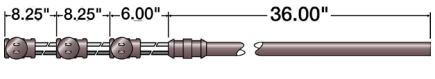
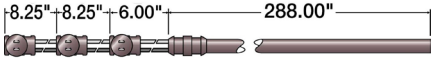
	Part Number	Number of Plugs	Wire Color	Wire Gauge	Position	Warranty
	50300	3	Brown, White	14		5-Year
	50301	3	Brown, White	14		5-Year
	50334	3	Brown, White	14		5-Year
	50367	3	Black White	14	Lower	5-Year
	50368	3	Black White	14	Upper	5-Year

FEATURES

- Standard stock length is on the diagram blunt cut to end seal

**50 SERIES,
ID | LICENSE HARNASS**

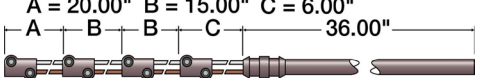
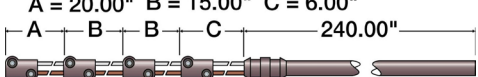
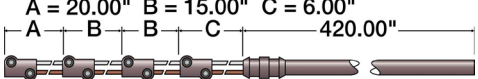
	Part Number	Number of Plugs	Wire Color	Wire Gauge	Position	Warranty
	50308	4	Brown, White	14	Lower	5-Year
	50335	4	Brown, White	14	Upper	5-Year
	50341	4	Brown, White	14	Upper	5-Year

50 SERIES

ID HARNASS

50 SERIES

ID | LICENSE HARNASS

**50 SERIES,
ABS HARNESS**

- Standard stock length is represented by the overall dimension on diagram

	Part Number	Number of Plugs	Wire Color	Wire Gauge	Warranty
	52100	2 (ABS Power harness with fault lamp harness)	Blue, Red, White	12	5-Year
	52200	1	Green, White	14	5-Year
	52203	1	Green, White	14	5-Year

**50 SERIES,
MARKER/CLEARNACE HARNESS,
1 PLUG**

FEATURES

- A range of cut length harnesses are available in 12” increments

	Part Number	Wire Color	Wire Gauge	Warranty
	50307	Black, White	14	5-Year
	50303	Brown, White	14	5-Year
	50351	Brown, White	14	5-Year
	50373	Black, White	14	5-Year
	50304	Brown, White	14	5-Year
	50374	Brown, White	14	5-Year
	50310	Black, White	14	5-Year
	50376	Black, White	14	5-Year
	50305	Brown, White	14	5-Year
	50375	Brown, White	14	5-Year

**50 SERIES,
MARKER/CLEARANCE HARNESS, 2 PLUG**

50 SERIES

	Part Number	Wire Color	Wire Gauge	Warranty
	50309	Brown White	14	5-Year
	50324	Brown White	14	5-Year
	50357	Brown White	14	5-Year
	51375	Brown White	14	5-Year
	50377	Brown White	14	5-Year

**50 SERIES,
MARKER/CLEARANCE HARNESS**

50 SERIES

MARKER/CLEARANCE HARNESS

FEATURES

- Wire Color: Brown/White
- Wire Gauge: 14
- Warranty: 5-Year
- A range of cut length harnesses are available in 12" increments

	Part Number	Plug
	50319	1 M/C Jumper
	50321	1
	50322	M/C with Jumper
	50331	1
	50350	1
	50356	M/C Jumper
	50381	M/C with Jumper
	50382	M/C with Jumper

continued...	Part Number	Plug
	50383	1
	50384	1
	50385	1
	51409	M/C Feed Jumper

SUPER 50, JUNCTION BOX, ROUND



FEATURES

- Made of high-impact, chemical-resistant plastic
- Mounted by four holes on 5-1/2" diameter circle
- Contains 8 pre-tapped holes to accept compression fittings or filler plugs



Part Number	Mounting Type	Housing Material	Number of Ports	Terminal Connections	Kit Includes/ Replacement Parts
50400	Surface	Plastic	8	8	50800 junction box, 50816 junction box cap, 50820 terminal block, four 50830 filler plugs and mounting and assembly screws
50401	Buckplate	Plastic	8	8	50801 junction box, 50816 junction box cap, 50820 terminal block, four 50830 filler plugs and mounting and assembly screws
50800	Surface	Plastic	8	0	
50801	Buckplate	Plastic	8	0	

(KIT)

(KIT)

SUPER 50, JUNCTION BOX, RECTANGULAR



FEATURES

- With 50% more harness ports, alleviates the need for multiple boxes, while allowing for the addition of more harness systems and increased lighting needs
- Larger box makes it easier to work on internal connections
- Clear lid offers easy viewing of connections without having to remove lid, saving time when trying to identify lighting system problems
- Made of high-impact, chemical-resistant, approved insulating plastic providing a long service life and eliminating the time and money needed for repair and replacement
- Mounted by four eyelet-reinforced holes in base of box for increased durability
- Contains 12 pre-tapped holes to accept compression fittings or filler plugs allowing for greater configuration versatility
- Uses 50 Series compression fittings or 50830 filler plugs (6 included in kit)

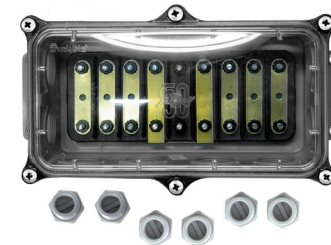
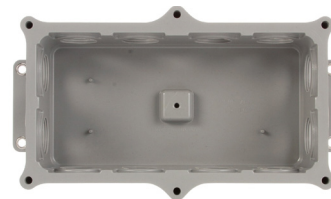

Part Number	Mount Type	Housing Color	Housing Material	Number of Ports	Terminal Connections	Kit Includes/ Replacement Parts
50601	Surface	Gray	Plastic	12	16	
50600	Surface	Gray Clear	Plastic	12	16	50601 junction box, 50832 junction box cap, 50602 hardware, terminal block

(KIT)

QUICK CONNECTION BOX
BUCKPLATE MOUNT,
RECTANGULAR



FEATURES

- Provides a secure connection to consumer trailers through a stripped wire connection or a stripped wire connection with a standard 4-pin flat molded connector
- Sealed connector to the main power harness in the truck
- Adhesive-lined heat shrinks protect the main harness connection to the box
- Quick connect box can be easily replaced if necessary
- The hinge pin has been designed to fit tightly into the hinge, keeping the lid on the box and reduces the chance for water to get into the connection terminals
- The black color of the box will allow it to blend into the rear bumper mounting location
- Easily adaptable for trailers, box trucks, retail vehicles, and box vans with a hitch set-up
- Mounting holes are in the same locations the current Phillips boxes
- 1/4" bolt used to mount the box



Part Number	Housing Color	Housing Material	Number of Ports	Terminal Connections	More Info
96511	Black	Nylon	1	4	w/o boat mold
96512	Black	Nylon	1	5	w/ boat mold



SIGNAL-STAT,
SURFACE MOUNT,
RECTANGULAR

FEATURES

- Seven #10-32 studs
- Scientifically engineered supporting ribs for extra strong construction
- Non-corrosive
- Mounting: Two holes on 7.69" centers
- Size: 8-1/2"L X 3-1/4"W X 2-1/8"H



Part Number	Housing Color	Housing Material	Number of Ports	Terminal Connections
3121	Black	Plastic	7	7



97956



97955

HEAT SHRINK TUBING

FEATURES

- Custom length available in 12" increments



Part Number	Gauge Wire	Conductor Size Min.	Conductor Size Max
97956	10-12	10	12
97955	14-16	14	16

JUNCTION BOXES

BUCKPLATE MOUNT

JUNCTION BOXES

SIGNAL-STAT

10-12 GAUGE

FUSES



FEATURES

- Ready to install, 6 or 12 volt
- Engineered for greater ease of use, fuse snaps into place
- Circuit may be examined without removal of fuse
- 6" 16 gauge looped wire
- Nylon housing assures greater durability
- Use to protect radios, fog lights, etc.

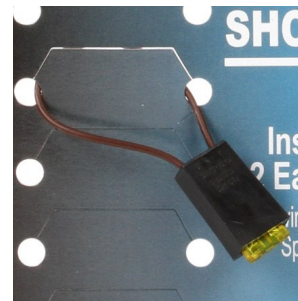

Part Number	Amps	Volts	Housing Material	Housing Material	Display
9414BL	20	6 or 12	Black	Nylon	No
9415BL	30	6 or 12	Black	Nylon	No
9410BL	30	12	Black	Nylon	Yes

50 SERIES, JUNCTION BOX LID



FEATURES | Kit

- Clear lid offers easy viewing of connections without having to remove lid, saving time when trying to identify lighting system problems
- Gasket on lid helps eliminate damage from moisture and corrosives
- High-impact, chemical resistant, approved insulated plastic provides long life, eliminates time & money for repair & replacement
- Replacement lid, gasket & screws

FEATURES | Gasket

- Clear lid offers easy viewing of connections without having to remove lid, saving time when trying to identify lighting system problems
- Gasket on lid helps to eliminate damage from moisture and corrosives within the box, reducing costly repairs

Part Number	Housing Material	Housing Color	Kit Includes
50606	PC	Clear	Lid & Screws (x6)
50607	PC		Lid, Gasket
50832	PC	Clear	Lid, Gasket, Screws (x6)

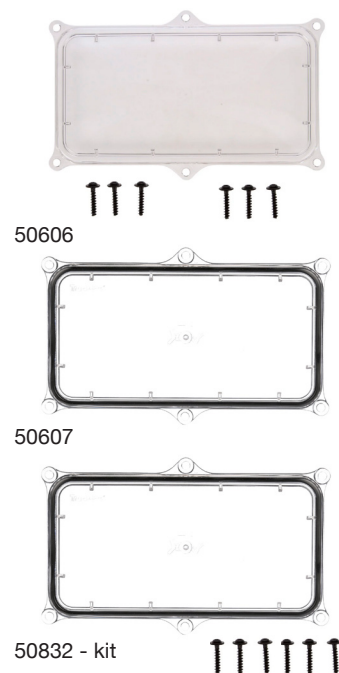

50 SERIES, TERMINAL BLOCK



FEATURES

- Made of approved insulating plastic
- Contains 8 color coded terminal posts

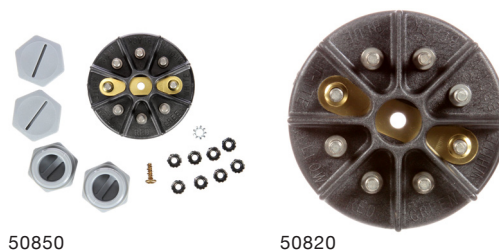

Part Number	Housing Color	Kit
50820	Black	
50850	Black	50820 terminal block, four 50830 filler plugs, assembly and mounting screws

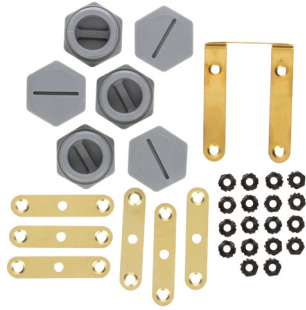

**50 SERIES,
JUNCTION BOX
HARDWARE, KIT**



Part Number
50602



**50 SERIES,
JUNCTION BOX CAP**



Part Number	Housing Color
50816	Gray
50812	Clear

50 SERIES

HARDWARE/CAP



**50 SERIES,
GROUND STRAP**



Part Number	Housing Color
50608	Brass

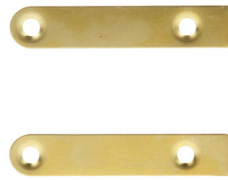

**50 SERIES,
DUALGROUND STRAP**



Part Number	Housing Color
50609	Brass

50 SERIES

STRAP



**50 SERIES,
FILLER PLUG**



Part Number	Housing Color
50830	Gray



**50 SERIES,
JAM NUT**



FEATURES

- Use for installation of 3-part compression fittings in areas other than in the junction boxes
- 1-1/8" clearance hole required

Part Number	Housing Color
50845	Gray

50 SERIES

FILL PLUG/JAM NUT



RING TERMINAL



Part Number
97912

FEATURES

- Non-Insulated terminals for use with "50 series" harnesses and junction boxes
- 25 per bag
- For 14-16 gauge wire only



TERMINAL



Part Number
97929

FEATURES

- Non-Insulated terminals for use with "50 series" harnesses and junction boxes
- 25 per bag
- For 14-16 gauge wire only

RING TERMINAL

WIRE SPLICES

WIRE SPLICES



Part Number	Gauge
97389	10-12
97390	14-16
97391	18-22

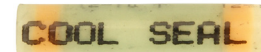

97389



97390



97391

1 CONDUCTOR

1 CONDUCTOR, COMPRESSION FITTING, PVC, 0.215"



FEATURES

- 3-part fitting consisting of a pre-tapped cap, threaded base and black PVC grommet
- Built for 5 single conductors



Part Number	# of Cables Per Fitting	Material Color
50843	5	Gray

2 CONDUCTOR

2 CONDUCTOR, COMPRESSION FITTING, DIE CAST, 0.375"



FEATURES

- For increased water resistance, an optional 3/8" ID water tight compression fitting is available and will accommodate a 2 conductor round cable.
- UL and CSA approved.



Part Number	# of Cables Per Fitting	Material Color
97003	1	Silver

2 CONDUCTOR

2 CONDUCTOR, COMPRESSION FITTING, PVC, 0.375"



FEATURES

- 3-part fitting consisting of a pre-tapped cap, threaded base and black PVC grommet



Part Number	# of Cables Per Fitting	Material Color
50840	1	Gray

2 CONDUCTOR

2 CONDUCTOR, FLAT CABLE FITTING, PVC, 0.31" X 0.19"



Part Number	# of Cables Per Fitting	Material Color
50848	1	Gray



**3 CONDUCTOR,
COMPRESSION FITTING, PVC, 0.45" X 0.19"**

Part Number	# of Cables Per Fitting	Material Color
50846	1	Gray

FEATURES

- 3-part fitting consisting of a pre-tapped cap, threaded base and black PVC grommet



3 CONDUCTOR



**4 CONDUCTOR,
COMPRESSION FITTING, PVC, 0.45" X 0.21"**

Part Number	# of Cables Per Fitting	Material Color
50847	1	Gray

FEATURES

- 3-part fitting consisting of a pre-tapped cap, threaded base and black PVC grommet



4 CONDUCTOR



**4 TO 5 CONDUCTOR,
COMPRESSION FITTING, PVC, 0.485"**

Part Number	# of Cables Per Fitting	Material Color
50841	1	Gray

FEATURES

- 3-part fitting consisting of a pre-tapped cap, threaded base and black PVC grommet that is available with 6 different hole sizes to accommodate various conductor cables



4-5 CONDUCTOR



**6 TO 7 CONDUCTOR,
COMPRESSION FITTING, PVC, 0.709"**

Part Number	# of Cables Per Fitting	Material Color
50842	1	Gray

FEATURES

- 3-part fitting consisting of a pre-tapped cap, threaded base and black PVC grommet that is available with 6 different hole sizes to accommodate various conductor cables



6-7 CONDUCTOR



**RIGHT ANGLE HARNESSES CLIP,
SILVER STEEL, 1.25"**

Part Number	Material Color	Size
97011	Silver	1.25"
97913	Silver	1.50"

FEATURES

- Steel clips
- Supplied with all multi-plug S/T/T harness



HARNESSES CLIP

NOSE BOX

50 SERIES

50 SERIES, 7 PIN, POLYCARBONATE



FEATURES

- Easily installed on new trailers or as a retrofit on existing equipment
- Chemical-resistant and virtually indestructible box
- Internal electrical contacts sealed to eliminate corrosion
- 100% pre-test electrically with a 40 amp capacity
- Available with or without circuit breakers
- Color-coded trailer main cable hook up terminals for proper connections

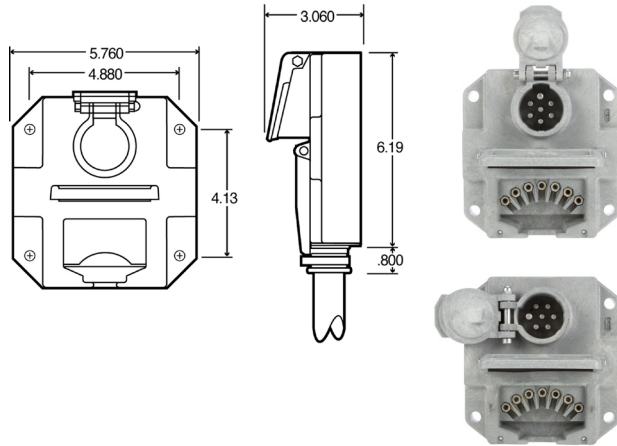

RIGHT ANGLE

Part Number	Housing Material	Housing Color	Number of Pins	Split/Solid Pin	Mount Type	Circuit Breaker	Angle
50805	PC	Gray	7	Solid Pin	Surface	No	Standard
50806	PC	Gray	7	Solid Pin	Surface	15 Amp	Standard

NOSE BOX

50 SERIES

50 SERIES, 7 PIN, PLASTIC



FEATURES

- Eliminates the need to rewire the nose box when replacing a damaged 7 way receptacle
- Replacement parts, 50898, 5813
- Fits standard mounting bolt pattern
- Includes 2 cable entry grommets
- Wiring remains stationary on studs inside the box
- No need to disturb wiring when replacing receptacle
- Receptacle simply plugs in and secures with 2 nuts
- Brass jumpers bridge from studs to receptacle pins

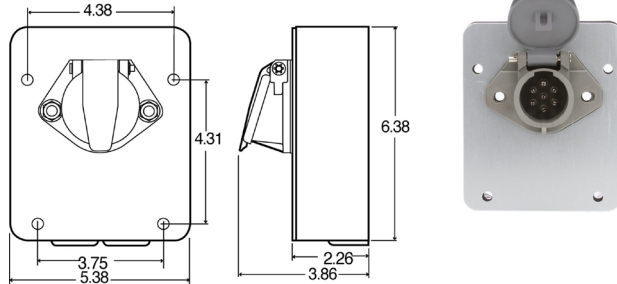

Part Number	Housing Material	Housing Color	Number of Pins	Split/Solid Pin	Mount Type	Angle	Circuit Breaker
50878	Plastic	Gray	7	Solid Pin	Surface	Standard	No
50879	Plastic	Gray	7	Split Pin	Surface	Standard	No

SPLIT PIN

SPLIT PIN



Part Number
50898

FEATURES

- Eliminates the need to rewire the nose box when replacing a damaged receptacle
- Replacement receptacle for smart boxes 50878/50879





FEATURES

- Easy installation on all receptacles
- Includes Noryl cover, steel hinge pin, stainless steel spring, cotter pin and shaft retainer
- Not for use with #50805 style 7-ways

SERVICE COVER, KIT

Part Number
50875

(KIT)



SERVICE COVER

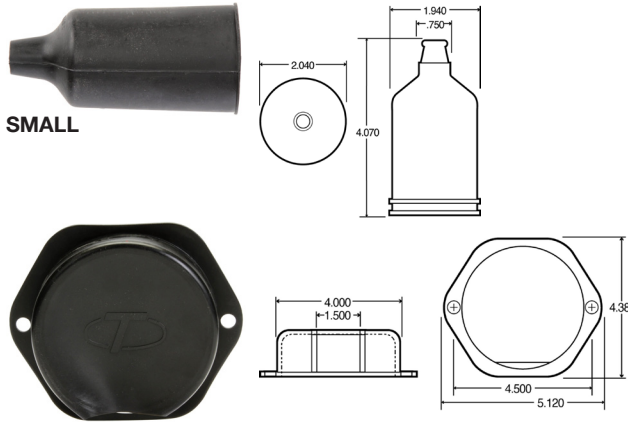

RECEPTACLE BOOT

FEATURES

- Protects electrical connections from moisture in flush mount applications
- Large boot fits all full-sized receptacles
- Small boots fits both 2 and 3 bolt flange receptacles with end or bottom access



RECEPTACLE BOOT

Part Number	Size
50890	Small
50892	Large



50889

50895

FEATURES

- Ensures that the full capacity of the shared blue circuit is available to the ABS when vehicle is moving
- Ensures that accessory leads are turned off
- Two 12 gauge 24" wires

ANCHOR TEE

Part Number	Plug Side 2
50889	Blunt Cut
50895	



ANCHOR TEE

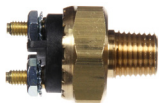

FEATURES

- Designed specifically for heavy-duty truck air brake systems
- Excellent for use in anti-lock applications
- Sensitive and rugged internal "snap action" spring insures precise opening/closing at both low and high pressure

SPOTLIGHT SWITCH

Part Number	Plug Side 2
50899	Blunt Cut



SPOTLIGHT SWITCH

ADAPTOR BOX

SURFACE MOUNT ADAPTOR BOX



FEATURES

- Features molded, threaded brass inserts for receptacle mounting
- Bottom entry for standard wiring with strain relief mechanism
- Available with back access hole to accommodate rear entry applications



REAR ACCESS

BOTTOM ACCESS

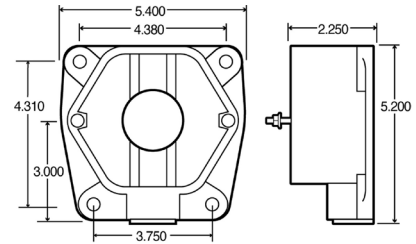

Part Number	Access	Mount Type
50882	Bottom	Surface
50883	Rear	Surface

CABLE GROMMET

CABLE GROMMET



Part Number
50807



CAP LATCH/REC COVER

CAP LATCH REPAIR KIT



Part Number
50808

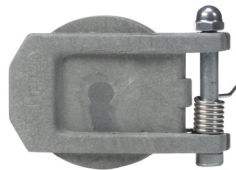

KIT

RECTANGULAR COVER, KIT



Part Number
50809



KIT

SPLIT PIN

50 SERIES, SPLIT PIN, STEEL



FEATURES

- Available in 7-way, 6-way, and 4-way variations
- Compact socket design with exposed terminals for easy installation in modern trailers
- Extended interior plug prevents damage to shell
- Integral finger grips for positive pull

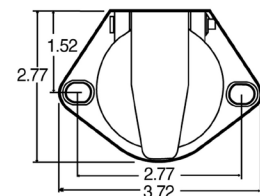

Part Number	Housing Material	Housing Color	Number of Pins
50886	Steel	Silver	4
50888	Steel	Silver	6
50896	Steel	Silver	7

**50 SERIES,
SPLIT PIN, 7 PIN**



SURFACE MOUNT



FLUSH MOUNT

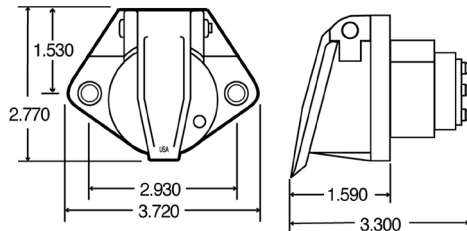
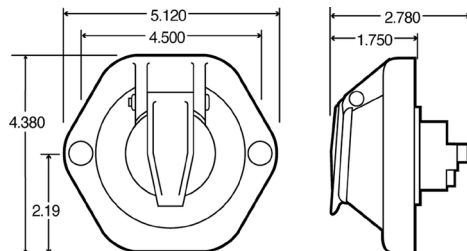

FEATURES

- Tough GE Noryl, non-conductive, corrosion resistant body
- Floating type, cadmium-plated brass pins allow best alignment and long-lasting contact with plug
- Internal connections feature a direct wired ground
- Circuits are identified by color codes and embossed notations
- Ring terminals are used to connect wires
- Receptacle pins prevent increased resistance due to strand breakage caused by set screws
- Available in standard and circuit breaker version
- Meets SAE J560 standards
- We recommend using rubber boots with flush mount receptacles

Part Number	Mount Type	Housing Material	Housing Color	Number of Pins	More Info
50861	Surface	Plastic	Gray	7	
50863	Surface	Plastic	Gray	7	15 Amps circuit breaker
50865	Surface	Plastic	Gray	7	15 20 Amp circuit breaker
50867	Surface	Plastic	Gray	7	Threaded Stacking Studs
50869	Flush	Plastic	Gray	7	
50872	Flush	Plastic	Gray	7	Push-On

**50 SERIES,
SOLID PIN, 7 PIN**

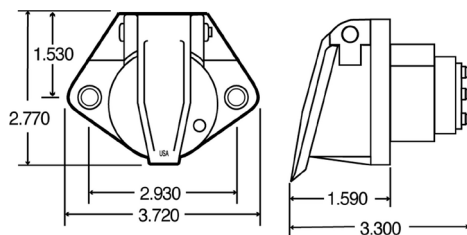

FEATURES

- Tough GE Noryl, non-conductive, corrosion resistant body
- Floating type, cadmium-plated brass pins allow best alignment and long-lasting contact with plug
- Internal connections feature a direct wired ground
- Circuits are identified by color codes and embossed notations
- Ring terminals are used to connect wires
- Receptacle pins prevent increased resistance due to strand breakage caused by set screws
- Available in standard and circuit breaker version
- Meets SAE J560 standards
- Push-on-terminal design
- We recommend using rubber boots when flush mounting receptacles

Part Number	Mount Type	Housing Material	Housing Color	More Info
50860	Flush	Plastic	Gray	
50866	Surface	Plastic	Gray	Threaded Stacking Studs
50868	Surface	Plastic	Gray	

TRAILER CORD, 7 CONDUCTOR, METAL



FEATURES

- Meets ATA, SAE and TMC requirements
- Designed for use in wide temperature range (-87°F to 195°F)
- Available in 12 and 15 foot lengths
- Meets or exceeds SAE J559 or J1067 as applicable
- 100% pre-tested

Part Number	Length	Plug Side 1	Plug Side 2	Wire Gauge
97151	12 feet	7 Pole Plug	7 Pole Plug	10 16
97153	15 feet	7 Pole Plug	7 Pole Plug	10 16

TRAILER CORD, 7 CONDUCTOR, NYLON



FEATURES

- Ideal for supplying power to trailer and dolly ABS systems
- Designed for use in wide temperature range (-87°F to 195°F)
- Available in 12 and 15 foot lengths
- Meets TMC recommendations (RP137) and SAE J2222
- 100% pre-tested





Part Number	Length	Plug Side 1	Plug Side 2	Wire Gauge
97160	12 feet	7 Pole Plug	7 Pole Plug	8 10 12
97161	15 feet	7 Pole Plug	7 Pole Plug	10 8 12

TRAILER CONNECTOR CABLE REPLACEMENT PLUGS

FEATURES

- Features brass terminals and rear moisture seal
- Unique 360° cable clamp that helps prevent the cable from being accidentally pulled out
- Resistant to degreasers, solvents and contact cleaners
- Features zinc die-cast housing and brass terminals
- Nylon insert is resistant to petro-chemicals



	Part Number	Conductors	Plug Side 1	Housing Material
	50885	4	4 Pole Plug	Steel
	50887	6	6 Pole Plug	Steel
	97158	7	7 Pole Plug	Plastic
	97159	7	7 Pole Plug	Steel

MIRRORS

CATEGORY	PAGE
Combination Mirrors	412
West Coast Mirrors	412-418
Flat Mirrors	418-426
Convex Mirrors	426-433
Mirror Bracket & Accessories	434-437

STEPVAN MIRROR ASSEMBLY

9"X 21", REGULAR



FEATURES

- Replacement heads for Grumman Olson, Union City Body and Utilimaster vehicles
- Silvered mirror glass resists pitting, peeling and corrosion
- Glass is mounted in vinyl gasket
- Features a brushed stainless steel finish
- Flexible, adjustable bracket expands from 21.65"-35.43" to fit most vehicles and offset mounting points
- Popular for use on step van and package delivery vans
- Assembly includes two mirrors-6-1/2"x10" flat glass head and 6-1/2"x6" convex glass head
- Fits to either side of the vehicle
- Mounting hardware and bracket also included

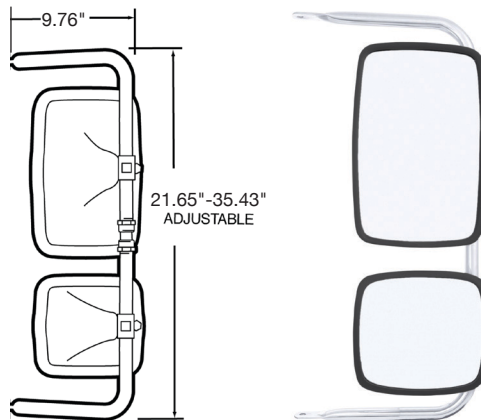

Part Number	Housing Color	Housing Material	Mounting Bracket	Replacement Parts
97846	Silver	Steel	Yoke	97847 flat mirror, 97733 head clamp
97668	Black	Steel	Yoke	97672 flat mirror, 97670 convex mirror, 97733 head clamp
97669	White	Steel	Yoke	97673 flat mirror, 97671 convex mirror, 97733 head clamp

JR. WEST COAST, 6"X 11", KIT

6"X 11", KIT



FEATURES

- Stainless steel mirror head
- Arms: 15" -24" vertical, stainless steel finish, 11" -15" horizontal, stainless steel finish
- Ideal for most pick-up trucks, small stake trucks and campers
- 7/8" hex compression nut fits heavy duty 3/4" tubing

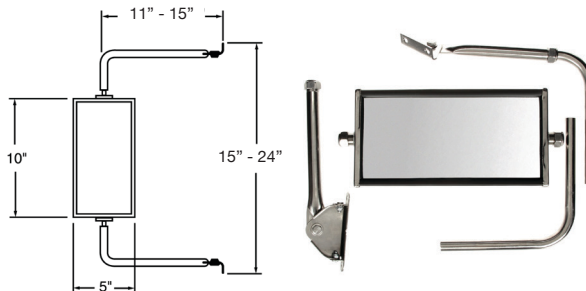

Part Number	Housing Color	Housing Material	Mounting Bracket
97644	Silver	Stainless Steel	West Coast Rigid Bracket

WIDE ANGLE MIRROR HEAD

6"X 16"



FEATURES

- 5/16" stud diameter, center rod
- Convex mirror on lower portion allows wide angle view without separate mirror

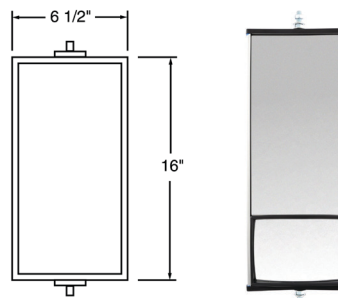

Part Number	Housing Color	Housing Material	Mounting Bracket
97632	Silver	Aluminum	—

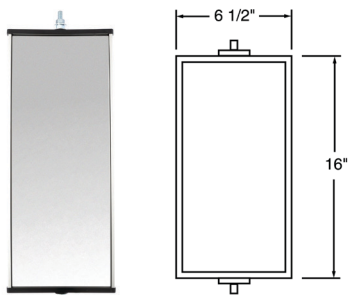

ECONOMY MIRROR HEAD 6"X 16"



FEATURES

- Rod through construction
- Steel end caps for strength
- 5/16" stud diameter with center rod
- Durable, economical replacement heads
- Electrostatic-applied paint provides additional corrosion protection
- Full vinyl gasket insulated mirror glass

Part Number	Housing Color	Housing Material	Mounting Bracket
97627	Silver	Aluminum	—
97628	White	Aluminum	—
97629	Black	Aluminum	—

6 IN X 16 IN

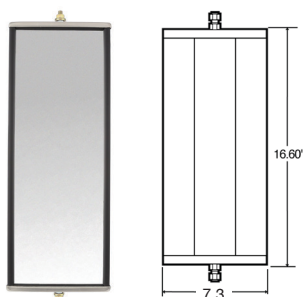

BOX STYLE MIRROR HEAD 7"X 16"



FEATURES

- Silvered mirror glass resists pitting, peeling and corrosion
- Glass is cushioned in a vinyl gasket
- Designed as a rod-through style head with a 5/16"-18 threaded rod

Part Number	Housing Color	Housing Material	Mounting Bracket
97812	Silver	Stainless Steel	—
97860	Silver	Aluminum	—

6 IN X 16 IN

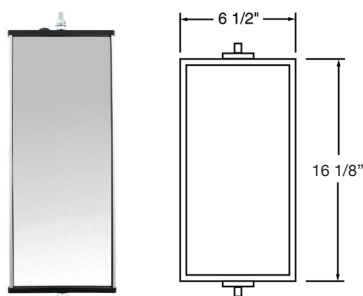

ECONOMY MIRROR HEAD 6"X 16", HEATED



FEATURES

- Rod-through construction
- Steel end caps for strength
- 5/16" stud diameter with center rod
- Durable, economical replacement heads
- Electrostatic applied paint provides additional corrosion protection
- Full vinyl gasket insulated mirror glass
- Heater keeps glass free from icing and fogging

Part Number	Housing Color	Housing Material	Mounting Bracket	Plug Side 2
97630	Silver	Aluminum	—	Stripped End

6 IN X 16 IN

6 IN X 16 IN

UNIVERSAL WEST COAST MIRROR ASSEMBLY KIT 6"X 16"



FEATURES

- Extends 18 -23" as needed
- Includes all hardware for easy assembly
- Swing away yoke helps prevent damage
- Fits all conventional style trucks
- Mirror glass mounted in ozone-resistant vinyl to isolate against road shock and vibration

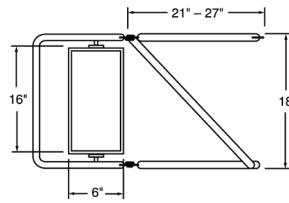

Part Number	Housing Color	Housing Material	Mounting Bracket	Kit Includes
97694	Black	Steel	West Coast Bracket	97629 mirror, 97726 bracket



6 IN X 16 IN

WIDE ANGLE WEST COAST MIRROR ASSEMBLY KIT 6"X 16"



FEATURES

- Arms: 25"-40" vertical, stainless steel finish 5" horizontal, stainless steel finish
- Fits any straight-sided vehicles and some tilt cabs
- Convex mirror on lower portion allows wide angle view without separate mirror
- 3/4" hex compression nut fits heavy duty 3/4" tubing

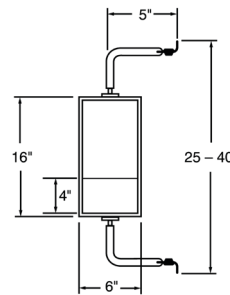

Part Number	Housing Color	Housing Material	Mounting Bracket	Replacement Parts
97633	Silver	430 Bright Stainless Steel	West Coast Rigid Bracket	-



7 IN X 16 IN

UNIVERSAL WEST COAST MIRROR ASSEMBLY KIT 7"X 16"



FEATURES

- Arms: 18" vertical span, 15"-20" horizontal adjustment
- Swing away yoke
- Fits most conventional style trucks
- Includes all hardware for easy assembly

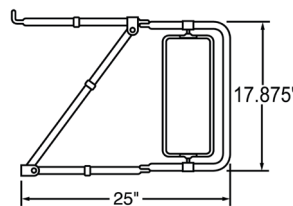

Part Number	Housing Color	Housing Material	Mounting Bracket	Replacement Parts
97693	Silver	Stainless Steel	West Coast Bracket	97822 mirror, 97725 bracket

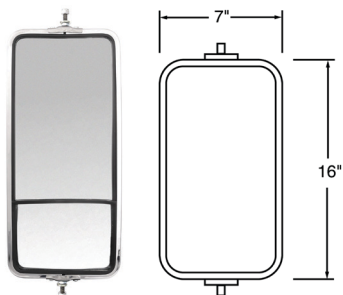

WIDE ANGLE MIRROR HEAD 7"X 16"

FEATURES

- Convex mirror on lower portion provides wide angle view
- 5/16-8" mounting stud
- Replaces Signal-Stat 7086



Part Number	Housing Color	Housing Material	Mounting Bracket
97635	Silver	Stainless Steel	—

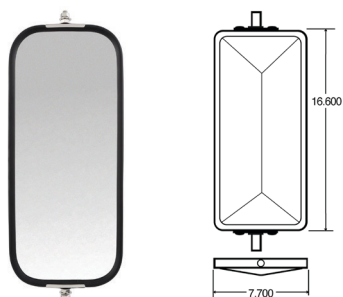

PYRAMID STYLE MIRROR HEAD 7"X 16"

FEATURES

- Ford, Chevy/GMC and other truck replacement heads
- Silvered mirror glass resists pitting, peeling and corrosion
- Glass is cushioned in a vinyl ozone-resistant gasket
- Fits most standard OEM west coast brackets
- Mounts on two 5/16"-18 bolts
- Includes west coast bracket and adapters for International Trucks



Part Number	Housing Color	Housing Material	Mounting Bracket
97861	Silver	Stainless Steel	—
97636	Black	Steel	—

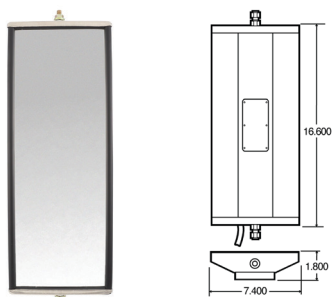

7"X 16"

FEATURES

- Freightliner/Sterling style replacement
- Silvered mirror glass resists pitting, peeling and corrosion
- Glass is cushioned in a vinyl ozone-resistant gasket
- Designed as a rod-through style head with a 5/16"-18 threaded rod
- Bright stainless steel, painted steel or economical aluminum finishes
- Fits most standard OEM west coast brackets and mounts on two 5/16"-18 bolts



Part Number	Housing Color	Housing Material	Mounting Bracket
97836	Silver	Stainless Steel	—

7 IN X 16 IN

7"X 16"



FEATURES

- Full 1/4" glass is cushioned with a vinyl gasket and meets OEM requirements
- Features a bright stainless steel finish
- Field replaceable heater p/n
- Field replaceable PTC heating element that provides continuous heat even in sub-zero temperatures
- Direct replacement for many OEM mirrors

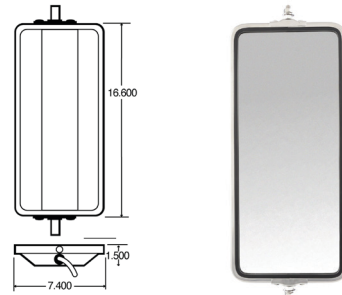

Part Number	Housing Color	Housing Material	Heated
97809	Silver	Stainless Steel	Yes
97822	Silver	Stainless Steel	No

7 IN X 16 IN

7"X 16"



FEATURES

- OEM replacement for International S-series and other trucks
- Full vinyl gasket insulated glass

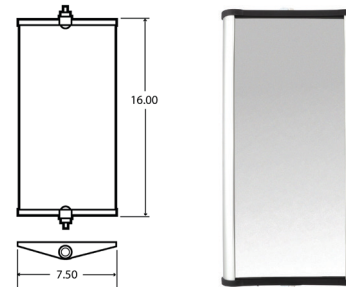

Part Number	Housing Color	Housing Material	Mounting Bracket
97624	Silver	Aluminum	—

7 IN X 16 IN

7"X 16"



FEATURES

- Silvered mirror glass resists pitting, peeling and corrosion
- Glass is cushioned in a vinyl ozone-resistant gasket
- Fits most standard OEM brackets with T-bolt mount
- Designed with a single-piece mirror back
- Bubble back and rib back designs are popular for use on construction and delivery trucks

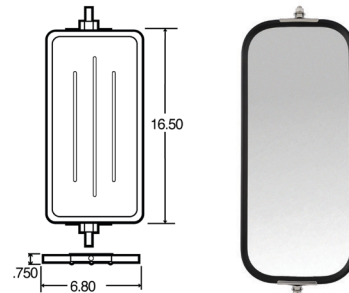

Part Number	Housing Color	Housing Material	Mounting Bracket	More Info
97806	White	Steel	—	Rib Back
97808	Black	Steel	—	Bubble Back
97818	White	Steel	—	Bubble Back

7"X 16", HEATED

7 IN X 16 IN

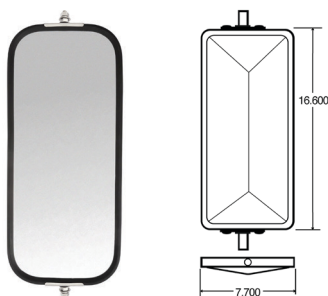

FEATURES

- Ford, Chevy/GMC and other truck replacement heads
- Silvered mirror glass resists pitting, peeling and corrosion
- Glass is cushioned in a vinyl ozone-resistant gasket
- Fits most standard OEM west coast brackets
- Mounts on two 5/16"-18 bolts
- Includes west coast bracket and adapters for International Trucks



Part Number	Housing Color	Housing Material	Mounting Bracket	Plug Side 2
97866	Silver	Stainless Steel	—	Stripped End

7"X 16", HEATED

7 IN X 16 IN

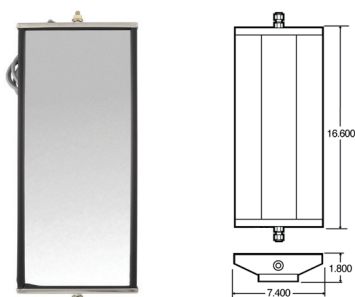

FEATURES

- Freightliner/Sterling style replacement
- Silvered mirror glass resists pitting, peeling and corrosion
- Glass is cushioned in a vinyl ozone-resistant gasket
- Designed as a rod-through style head with a 5/16"-18 threaded rod
- Bright stainless steel, painted steel or economical aluminum finishes
- Fits most standard OEM west coast brackets and mounts on two 5/16"-18 bolts



Part Number	Housing Color	Housing Material	Mounting Bracket	Plug Side 2
97837	Silver	Stainless Steel	—	Stripped End 60°

7"X 16", HEATED

7 IN X 16 IN

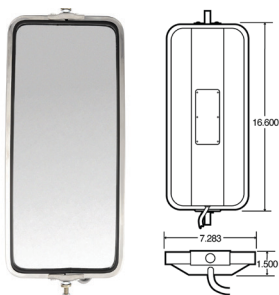

FEATURES

- Full 1/4" glass is cushioned with a vinyl gasket and meets OEM requirements
- Features a bright stainless steel finish
- Field replaceable PTC heating element that provides continuous heat even in sub-zero temperatures
- Direct replacement for many OEM mirrors
- With clearnace lighting



Part Number	Housing Color	Housing Material	Mounting Bracket	Plug Side 2
97827	Silver	Stainless Steel	—	Stripped End

7 IN X 16 IN

7"X 16", HEATED



FEATURES

- Silvered mirror glass resists pitting, peeling and corrosion
- Glass is cushioned in a vinyl ozone-resistant gasket
- Fits most standard OEM brackets with T-bolt mount
- Field replaceable PTC heating element that provides continuous heat even in sub-zero temperatures
- Designed with a single-piece mirror back
- Bubble back and rib back designs are popular for use on construction and delivery trucks

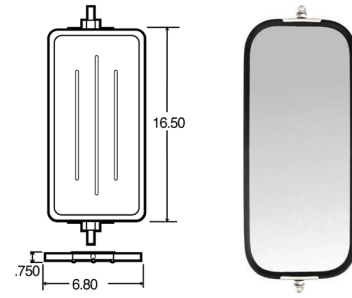

Part Number	Housing Color	Housing Material	Mounting Bracket	Plug Side 2
97650	Black	Steel	—	Stripped End

7 IN X 16 IN

7"X 16", HEATED



FEATURES

- Silvered mirror glass that resists pitting, peeling and corrosion
- Light weight stainless steel housing weighs only 4 lbs.
- Features a sealed gearless motor that withstands manual adjustment without damage
- Turning mechanism designed to eliminate over rotation with built-in 60° adjustment limits
- Field replaceable PTC heating element that provides continuous heat even in sub-zero temperatures
- Motorized version includes electrical wiring, switches and installation instructions
- Fits most standard OEM brackets and mounts on two 5/16"-18 bolts

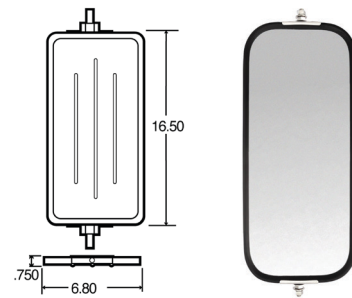

Part Number	Housing Color	Housing Material	Mounting Bracket	Plug Side 2
97840	Silver	Stainless Steel	—	Female Blade Terminal

5 IN ROUND

FLAT MIRROR SINGAL-STAT, 5" ROUND



FEATURES

- Mounts with a 5/16" adjustable, female threaded ball stud to help prevent thread damage
- Includes L-bracket
- Features flat glass surface
- Replaces Signal-Stat 7319/7328

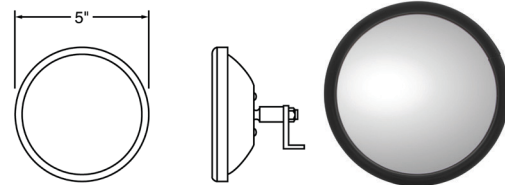

Part Number	Housing Color	Housing Material	Mounting Bracket
97611	Black	Steel Hsg	L Bracket
97612	White	Stainless Steel	L Bracket

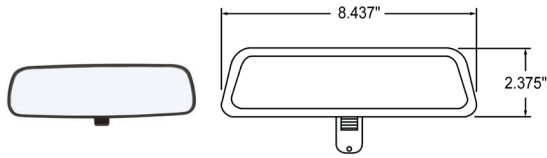

SIGNAL-STAT, 2\"/>

FEATURES

- Day and night prismatic ground glass
- Application button included (glue not included)
- Fits most Chrysler and import vehicle windshields



Part Number	Housing Color	Housing Material	Mounting Bracket
7619	Black	Vinyl	Window Mount

2 IN X 8 IN RECTANGULAR

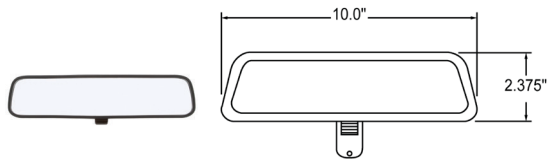

SIGNAL-STAT, 2\"/>

FEATURES

- Day and night prismatic ground glass
- Application button included (glue not included)
- Fits most AMC, Ford and GM windshields



Part Number	Housing Color	Housing Material	Mounting Bracket
7618	Black	Vinyl	Window Mount

2 IN X 10 IN RECTANGULAR

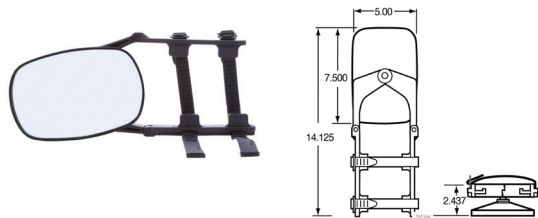

SIGNAL-STAT, 5\"/>

FEATURES

- Fits most pickups and vans
- Reduces accidents
- Installs with rubber strap to provide broad viewing area
- Black plastic housing with adjustable arm
- Flat lens with no distortion



Part Number	Housing Color	Housing Material	Mounting Bracket
7973D	Black	Plastic	Adjustable Arm

5 IN X 7.5 IN RECTANGULAR

SIGNAL-STAT, 5.5"X 7.5" RECTANGULAR



FEATURES

- Silvered glass that resists pitting, peeling and corrosion
- Glass is mounted in vinyl gasket
- Features white, electrostatic-painted steel finish
- 5-1/2" x 7-1/2" mirror head uses 5/16" - 16" adjustable, female threaded ball stud to prevent thread damage
- For use as a general purpose mirror

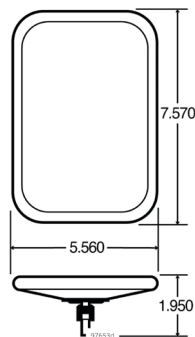

Part Number	Housing Color	Housing Material
97653	Silver	Stainless Steel
97654	Black	Steel
97807	White	Steel

5.5"X 7.5" RECTANGULAR



FEATURES

- For small pick-ups
- Center bracket mount
- Ozone-resistant vinyl gasket
- Replacement head for part #97678

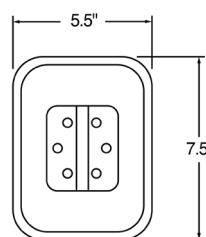

Part Number	Housing Color	Housing Material	Mounting Bracket
97655	Silver	Stainless Steel	Center Bracket

5.5"X 7.5" RECTANGULAR



FEATURES

- Silvered glass that resists pitting, peeling and corrosion
- Glass is mounted in vinyl gasket
- Features white, electrostatic-painted steel finish
- 5-1/2" x 7-1/2" mirror head uses 5/16" - 16 adjustable, female threaded ball stud to prevent thread damage
- For use as a general purpose mirror

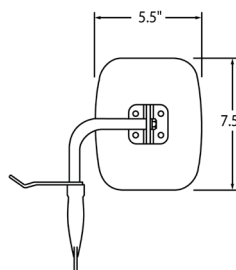

Part Number	Housing Color	Housing Material	Mounting Bracket
97678	Silver	Stainless Steel	Tripod Bracket

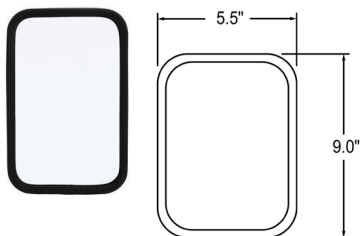

5.5"X 8.5" RECTANGULAR

FEATURES

- Features flat glass surface
- Popular size is ideal for use on moving and package delivery vehicles
- Soft vinyl gasket fully encases mirror glass to cushion against damaging vibration
- 5/16" adjustable ball stud mounting



Part Number	Housing Color	Housing Material	Mounting Bracket
97656	Silver	Stainless Steel	L Bracket
97657	Black	Steel	L Bracket

5.5 IN X 8.5 IN RECTANGULAR

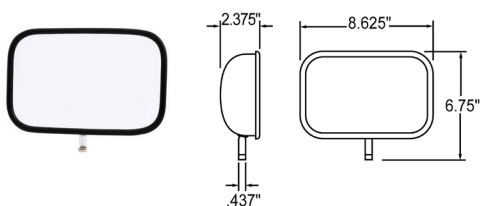

SIGNAL-STAT, 5.5"X 8.5" RECTANGULAR



FEATURES

- OEM replacement for Ford F-Series
- Replacement for 7217 and 7218 assemblies
- 1/4" female ball stud



Part Number	Housing Color	Housing Material	Position	Mounting
7223	Silver	Stainless Steel	LH	Ball / Stud
7224	Silver	Stainless Steel	RH	Ball / Stud

5.5 IN X 8.5 IN RECTANGULAR

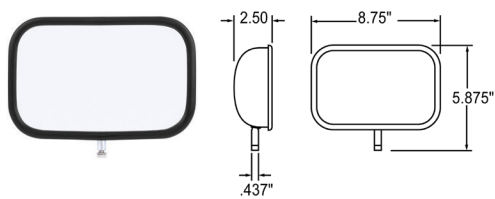

SIGNAL-STAT, 5.5"X 8.5" RECTANGULAR



FEATURES

- Universal replacement head
- Replacement head for 7555 and 7557
- 1/4" female ball stud



Part Number	Housing Color	Housing Material
7268	Black	ABS
7269	Chrome	ABS

5.5 IN X 8.5 IN RECTANGULAR

SIGNAL-STAT, 5"X 9" RECTANGULAR



FEATURES

- Ford FOTZ-17696B and FOTZ-17696A
- Fits F-Series Pickups, Broncos 1987-1991; Vans 1975-1991
- Door mount with swing away feature
- Aerodynamic design
- Aluminum arm
- Stainless steel is corrosion-free

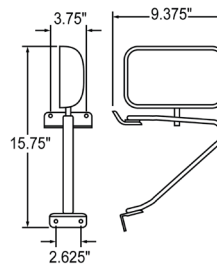

Part Number	Housing Color	Housing Material	Mounting Bracket	Position
7217	Silver	Stainless Steel	Angled Bracket	LH
7218	Silver	Stainless Steel	Angled Bracket	RH

SIGNAL-STAT, 5"X 9" RECTANGULAR



FEATURES

- Fits both left and right sides
- Door mount with swing away feature
- Aluminum arm
- ABS plastic is corrosion-free

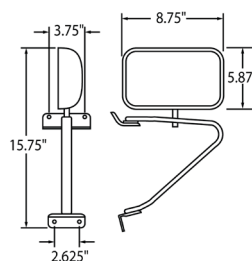

Part Number	Housing Color	Housing Material	Mounting Bracket
7555	Chrome	ABS	Door Mount

6"X 6.5" RECTANGULAR



FEATURES

- Silvered mirror glass resists pitting, peeling and corrosion
- Glass is mounted in vinyl, ozone-resistant gasket
- Brushed painted or stainless steel finish
- For use with 97846 and other assemblies

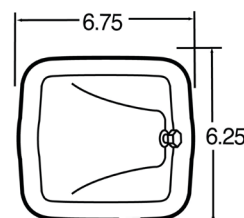

Part Number	Housing Color	Housing Material
97674	Silver	Stainless Steel
97675	Black	Steel
97676	White	Steel

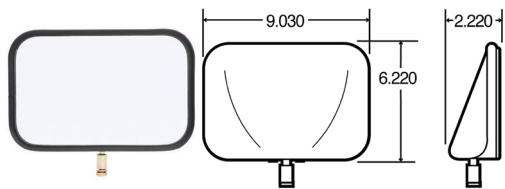

6" X 9"
RECTANGULAR

FEATURES

- Silvered mirror glass resists pitting, peeling and corrosion
- Glass is mounted in vinyl gasket
- 6" x 9" mirror head mounts with 5/16" - 18 female threaded ball stud



Part Number	Housing Color	Housing Material
97659	Black	Stainless Steel

7 IN X 9 IN RECTANGULAR

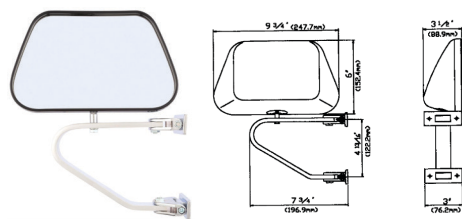

6.25" X 9.5"
RECTANGULAR

FEATURES

- Ideal for domestic and import pick-ups, vans and RVs
- Swing away brackets prevent damage
- Fits right or left side
- Corrosion-free ABS plastic and durable stainless steel models available
- Comes complete with aluminum arms and hardware
- Adjustable head assembly



Part Number	Housing Color	Housing Material
97750	Chrome	Plastic

6.25 IN X 9.5 IN RECTANGULAR

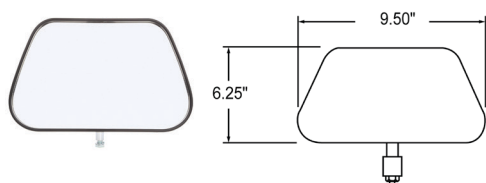

6.25" X 9.5"
RECTANGULAR

FEATURES

- Replacement head for part #97750
- Features chrome-plated plastic corrosion free housing
- Replaces Signal-Stat 7065



Part Number	Housing Color	Housing Material
97794	Chrome	Plastic

6.25 IN X 9.5 IN RECTANGULAR

6.5" X 10" RECTANGULAR



FEATURES

- Silvered mirror glass resists pitting, peeling and corrosion
- Glass is mounted in vinyl, ozone-resistant gasket
- Brushed painted or stainless steel finish
- For use with 97846 and other assemblies

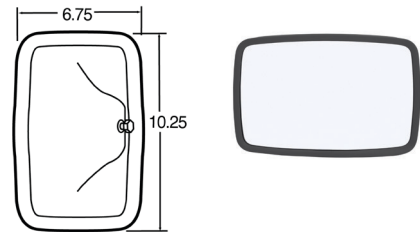

Part Number	Housing Color	Housing Material
97673	White	Steel
97847	Silver	Stainless Steel

SIGNAL-STAT, 7" X 9" RECTANGULAR



FEATURES

- GM 156976331 and 15697332
- Fits Suburban, Blazer, Yukon and Tahoe
- Pillar mount - near corner of side window
- Left Hand
- Chrome-plated steel is corrosion free
- Black zinc die-cast base

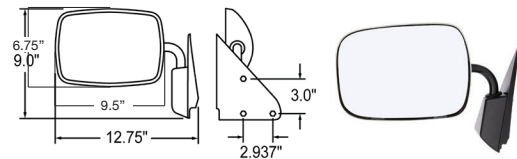

Part Number	Housing Color	Housing Material	Mounting Bracket
7519	Chrome	Steel	Pillar Mount

SIGNAL-STAT, 7" X 9" RECTANGULAR



FEATURES

- Fits Chevy and GMC vans and pick-ups
- Extra wide field of vision
- Universal mounting bracket, fits right or left side
- Rust and corrosion resistant

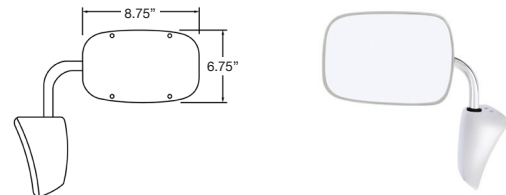

Part Number	Housing Color	Housing Material	Mounting Bracket
7575	Chrome	Steel	Door Mount

SIGNAL-STAT, 7" X 14" RECTANGULAR



FEATURES

- Convex glass with no distortion
- Does not meet FMVSS 111 requirements for West Coast Mirrors
- Use for added safety on off-highway equipment
- Fits 5/8" O.D. mirror tubes
- Black ABS plastic housing
- Includes mounting clamp which tightens onto mirror tube with one screw

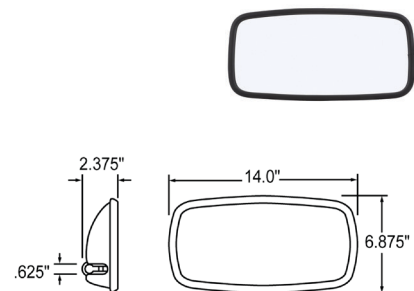

Part Number	Housing Color	Housing Material
7460	Black	Plastic

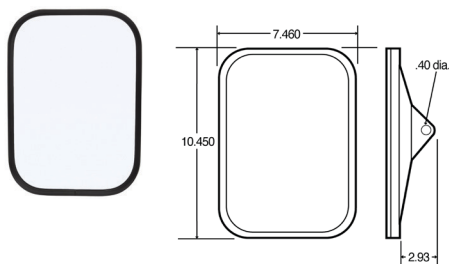

MEDIUM DUTY TRUCK MIRROR HEAD

7.5"X 10.5"

FEATURES

- Silvered mirror glass resists pitting, peeling and corrosion
- Glass is mounted in vinyl gasket
- Features bright stainless steel finish
- 7-1/2" x 10-1/2" mirror head uses center mount brackets to attach to assembly
- For use as a replacement for 97852 mirror assemblies
- Stainless steel replacement head for 97681



Part Number	Housing Color	Housing Material
97660	White	Steel
97805	Silver	Stainless Steel

7.5 IN X 10.5 IN RECTANGULAR

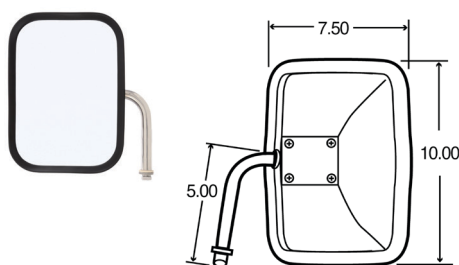

MEDIUM DUTY TRUCK MIRROR HEAD

7.5"X 10.5", RECTANGULAR

FEATURES

- Popular replacement for Ford, Chevy and Dodge trucks
- Features internal stainless steel elbow



Part Number	Housing Color	Housing Material	Mounting Bracket	Bracket Length
97661	Silver	Stainless Steel	Elbow Tripod Bracket	4in
97662	Silver	Stainless Steel	Elbow Tripod Bracket	5in

7.5 IN X 10.5 IN RECTANGULAR

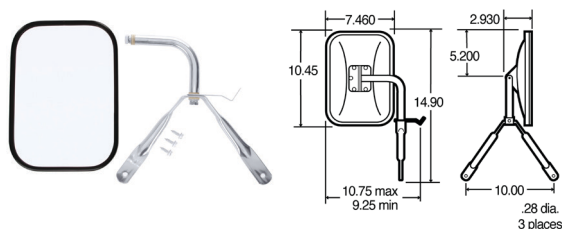

7.5"X 10.5" RECTANGULAR

FEATURES

- Fits both right and left side of Chevy, Ford, GMC and other pick-ups and vans
- Features "second surface" silvered glass that resists pitting, peeling and corrosion
- Glass is mounted in vinyl gasket
- Slotted top bracket allows assembly to fit most light and medium duty vehicles
- Fits either the left or right side
- Assembly features bright stainless steel finish
- Includes 7-1/2" x 10-1/2" mirror, mounting hardware and instructions



Part Number	Housing Color	Housing Material	Mounting Bracket
97680	White	Steel	Tripod Bracket
97852	Silver	Stainless Steel	Tripod Bracket

7.5 IN X 10.5 IN RECTANGULAR

7.5 IN X 10.5 IN RECTANGULAR

DOOR/FENDER ASSEMBLY KIT

7.5"X 10.5", RECTANGULAR



FEATURES

- Head can be positioned outside for wide vehicles or inside for narrow clearances
- Mounts below eye level to improve visibility to the front of vehicle
- Rugged stainless steel bracket
- Kit includes mounting brackets and instructions
- Designed for full size pick-up trucks
- Size: 7-1/2" x 10-1/2" mirror head

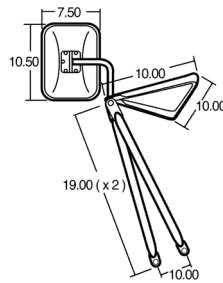

Part Number	Housing Color	Housing Material	Mounting Bracket
97681	Silver	Stainless Steel	Tripod Bracket

7.5 IN X 10.5 IN RECTANGULAR

INTERNAL ELBOW TRIPOD ASSEMBLY KIT

7.5"X 10.5", RECTANGULAR



FEATURES

- Designed for full size pick-up trucks
- Extendable for trailer towing by swinging head out
- Glass mounted in ozone-resistant vinyl gasket
- Kit includes mounting hardware and instructions

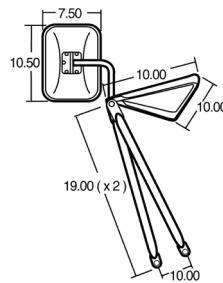

Part Number	Housing Color	Housing Material	Mounting Bracket
97682	Silver	Stainless Steel	Tripod Bracket

SIGNAL-STAT ROUND

SIGNAL-STAT, ROUND



FEATURES

- Eliminates blind spots
- Adhesive back mirrors will mount on any clean flat surface
- Triples viewing area
- Black plastic housing
- Enhances viewing area for rectangular and square OEM side view mirrors

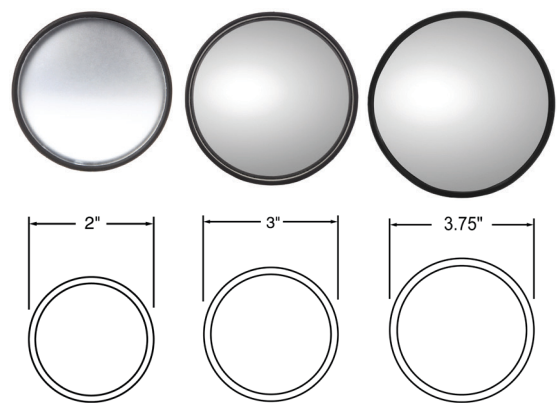

Part Number	Size	Housing Color	Housing Material	Packaging Type
7038	2 Inch	Black	Plastic	
7039	3 Inch	Black	Plastic	
7044	4 Inch	Black	Aluminum	
7044DB	4 Inch	Black	Aluminum	Display

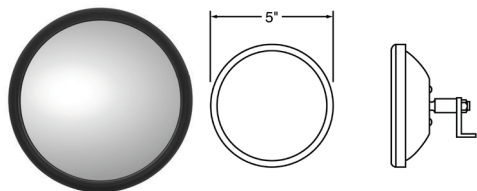

5" ROUND

FEATURES

- Zinc-plated universal mounting kit
- Round with universal mounting kit
- L-bracket included
- Mounts with a 5/16" adjustable, female threaded ball stud to help prevent thread damage



Part Number	Housing Color	Housing Material	Mounting Bracket
97618	Silver	Steel	L Bracket
97619	Black	Steel	L Bracket
97620	White	Steel	L Bracket

5 IN ROUND

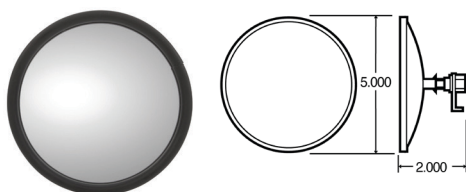

5" ROUND

FEATURES

- Convex glass is mounted in vinyl gasket for extra protection
- Available in bright stainless steel or black electrostatic-painted finishes
- Mounts with a 5/16" adjustable, female threaded ball stud to help prevent thread damage
- Includes L-bracket for ease in replacement



Part Number	Housing Color	Housing Material	Mounting Bracket
97802	Black	Steel	L Bracket
97872	Silver	Stainless Steel	L Bracket

5 IN ROUND

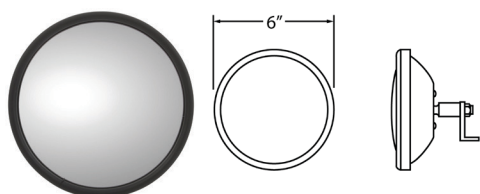

6" ROUND

- Zinc-plated universal mounting kit
- Round with universal mounting kit
- L-bracket included
- Mounts with a 5/16" adjustable, female threaded ball stud to help prevent thread damage



Part Number	Housing Color	Housing Material	Mounting Bracket
97621	Silver	Steel	L Bracket
97622	Black	Steel	L Bracket
97623	White	Steel	L Bracket

6 IN ROUND

6" ROUND



FEATURES

- Convex mirror replacement heads
- L-bracket included
- Mounting: 5/16" - 24 female ball stud

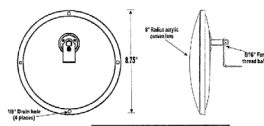

Part Number	Housing Color	Housing Material	Mounting Bracket
97819	Silver	Steel	L Bracket
97820	Black	Steel	L Bracket

7.5" ROUND



FEATURES

- Includes L-bracket
- Mounting: 5/16" female adjustable ball stud and bolt

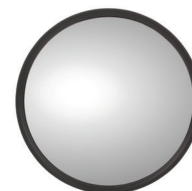
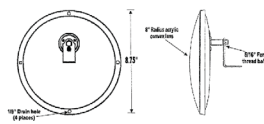

Part Number	Housing Color	Housing Material	Mounting Bracket
97815	Silver	Stainless Steel	Stainless center mount
97816	Black	Steel	Stainless offset mount
97817	Silver	Stainless Steel	Black center mount and ribbed

8" ROUND



FEATURES

- Universal tripod bracket mounts easily to most Ford, Chevy and Dodge Vans
- Assembly includes 8" mirror head, tripod bracket, stainless steel hardware and fasteners
- Primarily used for rear vision when backing up vehicle
- 5/16" adjustable female ball stud and mount

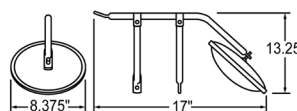

Part Number	Housing Color	Housing Material	Mounting Bracket
97664	Silver	Stainless Steel	Tripod Bracket
97665	White	Steel	Tripod Bracket

8" ROUND



FEATURES

- Designed for conventional long nose trucks
- Bell mounts include 3" coated washers and 3" steel washers to prevent damage to fiberglass fenders
- Main arm expands from 22" to 31"; top support arm expands from 14" to 21"; bottom support arm is 12", non-adjustable

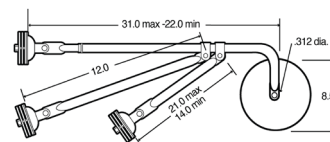

Part Number	Housing Color	Housing Material	Mounting Bracket
97686	Black	Steel	Tripod Bracket

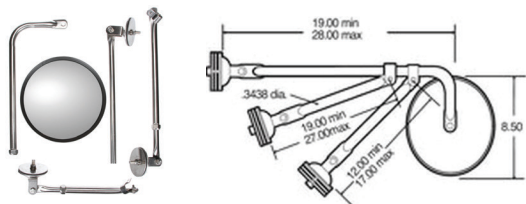

8" ROUND

FEATURES

- Designed for newer aerodynamic styled heavy duty trucks
- Fits most fiberglass, steel and aluminum fenders and hoods
- Stainless steel construction and fasteners



Part Number	Housing Color	Housing Material	Mounting Bracket
97687	Silver	Stainless Steel	Tripod Bracket



8" ROUND

FEATURES

- Kit includes convex mirror head, nickel-plated brass compression nuts, straight and curved arm bracket, installation instructions



Part Number	Housing Color	Housing Material	Mounting Bracket
97688	Silver	Stainless Steel	Curved Arm

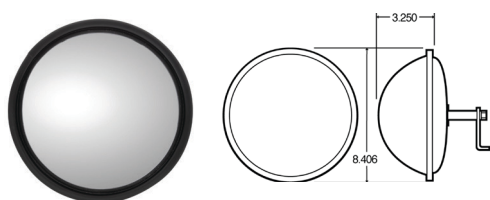

8.5" ROUND

FEATURES

- Features a black, electrostatic-painted finish
- Acrylic mirror is mounted in a vinyl gasket
- Extra-wide design helps eliminate blind spots for medium duty vehicles
- Mounts on a 5/16" adjustable, female threaded ball stud to prevent thread damage
- For use on many medium duty vehicles and buses
- Includes L-bracket for ease of replacement



Part Number	Housing Color	Housing Material	Mounting Bracket
97606	Silver	Steel	L Bracket
97831	Black	Steel	L Bracket

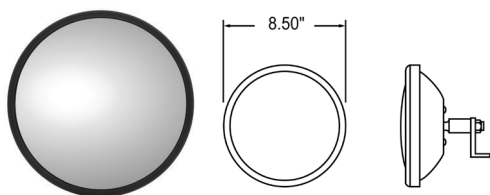

8.5" ROUND

FEATURES

- Offset mounting stud
- Includes L-bracket
- 2.5 amps 12 VDC only
- 60" wire length (can use switch #102 or #132)
- Heated mirror installation kit #7940 is available
- Mounting: 5/6" female threaded adjustable ball stud with 1/2" bolt



Part Number	Housing Color	Housing Material	Mounting Bracket	Plug Side 2
97614	Silver	Steel	L Bracket	Stripped End
97615	Black	Steel	L Bracket	Stripped End

8.5" ROUND



FEATURES

- Popular school bus convex head
- Center stud
- Includes L-bracket
- Mounting: 5/16" female adjustable ball stud and bolt

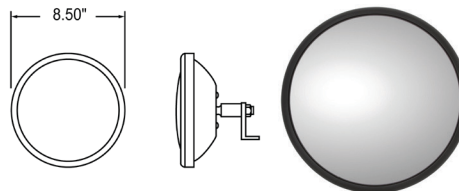

Part Number	Housing Color	Housing Material	Mounting Bracket
97803	Silver	Steel	Center mount
97804	Black	Steel	Center mount
97814	Silver	Steel	Offset mount

10.5" ROUND



FEATURES

- Universal mounting bracket fits on step vans and other vehicles with flat mounting area
- Assembly includes 10-1/2" mirror head, reinforced 3/4" O.D. tubing arm, heavy duty mounting brackets and stainless steel hardware
- 5/16" adjustable female ball stud and mount

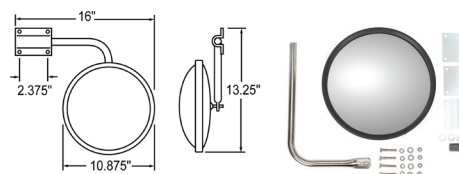

Part Number	Housing Color	Housing Material	Mounting Bracket
97862	Black	Steel	Universal Mounting Bracket

10.5" ROUND



FEATURES

- Replacement mirror head for vans, straight trucks and panel trucks
- Directly replaces mirror head on 97862 assemblies
- 5/16" adjustable female ball stud and bolt included
- Acrylic lens mounted in ozone vinyl
- Increases visibility in blind spots

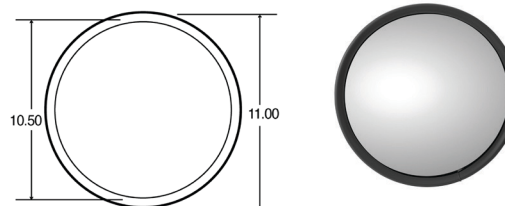

Part Number	Housing Color	Housing Material	Mounting Bracket
97863	Black	Steel	Universal Mounting Bracket

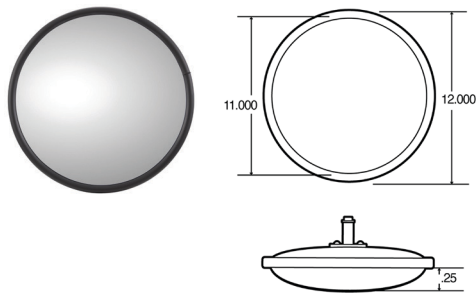

12" ROUND

FEATURES

- Ideal spot mirror for large off-highway construction and earth moving equipment
- Popular as interior spot mirror on transit bus applications
- Internal construction features reinforced retainers for durability and strength
- Corrosion resistant powder coated finish
- Large 1" steel ball stud with 3/8" - 24 threads for secure mounting and precise positioning
- Soft vinyl gasket fully encases mirror glass to cushion against damaging vibration



Part Number	Housing Color	Housing Material
97609	Black	Steel
97610	White	Steel
97835	Gray	Steel

12 IN ROUND

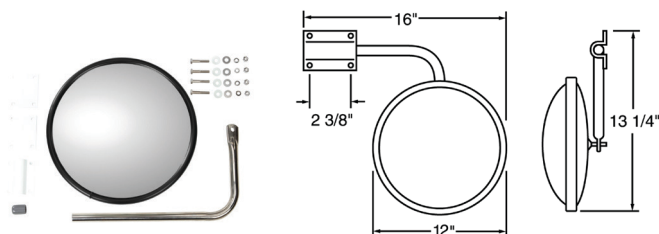

12" ROUND

FEATURES

- Bracket fits most step, cargo and delivery vans
- Reinforced 3/4" tubing and heavy-duty bracket



Part Number	Housing Color	Housing Material	Mounting Bracket
97667	Grey	Cold Rolled Steel	90 Degree Mounting Arm

12 IN ROUND

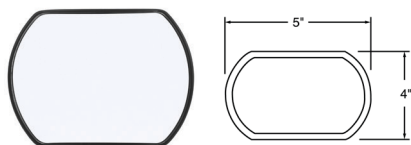

SIGNAL-STAT, 4"X 5" RECTANGULAR

FEATURES

- Eliminates blind spots
- Adhesive back mirrors will mount on any clean flat surface
- Triples viewing area
- Black plastic housing
- Enhances viewing area for rectangular and square OEM side view mirrors



Part Number	Housing Color	Housing Material	Packaging Type
7048	Black	Plastic	

4 IN X 5 IN RECTANGULAR

4"X 8" RECTANGULAR



FEATURES

- Features silvered glass that resists pitting, peeling and corrosion
- Features a bright stainless steel finish
- Convex mirror adds vision to trucks, buses and other vehicles
- Fits either side of the vehicle
- Includes stainless steel mounting bracket
- Mounts above down window

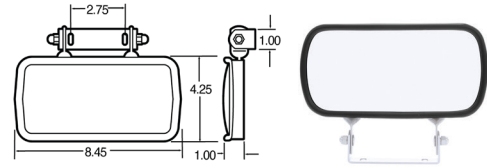

Part Number	Housing Color	Housing Material
97865	Silver	Stainless Steel

5"X 9" RECTANGULAR



FEATURES

- Convex glass with no distortion
- Does not meet FMVSS 111 requirements for West Coast Mirrors
- Universal application for added safety
- Fits 5/8" O.D. mirror tubes
- Black ABS plastic housing
- Includes mounting clamp which tightens onto mirror tube with one screw

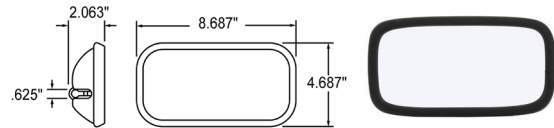

Part Number	Housing Color	Housing Material
7450	Black	ABS

6"X 6" RECTANGULAR



FEATURES

- Silvered mirror glass resists pitting, peeling and corrosion
- Glass is mounted in vinyl ozone-resistant gasket
- Brushed painted or stainless steel finish
- For use with 97846 and other assemblies

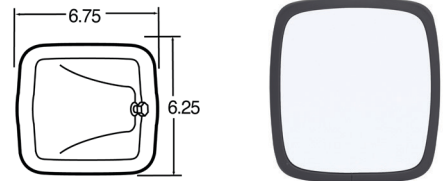

Part Number	Housing Color	Housing Material
97670	Black	Steel
97671	White	Steel
97848	Silver	Stainless Steel

6"X 8" RECTANGULAR



FEATURES

- Convex glass with no distortion
- Does not meet FMVSS 111 requirements for West Coast Mirrors
- Universal application for added safety
- Fits 5/8" O.D. mirror tubes
- Black ABS plastic housing
- Includes mounting clamp which tightens onto mirror tube with one screw

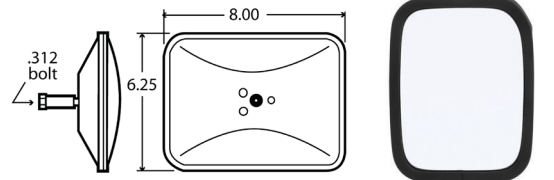

Part Number	Housing Color	Housing Material	Mounting Bracket
97602	Silver	Stainless Steel	Tripod Fender Mount Brackets
97603	Black	Steel	Tripod Fender Mount Brackets

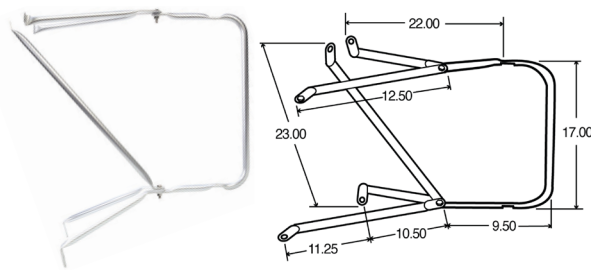

WEST COAST MIRROR BRACKET

FEATURES

- Replacement for International Truck S-Series (4000-4700)
- Includes brackets, outer yoke, clamps and hardware
- Mirror not included



Part Number	Compatible Parts	Mount Type	Mount/Trim Color	Mount/Trim Material
97695	97624 Mirror Head, 97625 Mirror Head	Yoke	Silver	Aluminum

MIRROR BRACKET

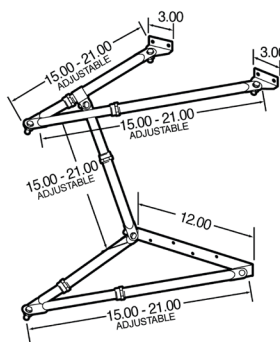
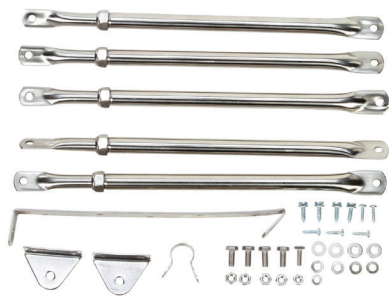

MOUNTING BRACKET

FEATURES

- Features heavy-duty, stainless steel construction
- Includes steady brace, hardware and assembly instructions
- Adjusts to fit most medium and heavy duty trucks
- For use with 6" x 16" or 7" x 16" west coast mirror heads



Part Number	Compatible Parts	Mount Type	Mount/Trim Color	Mount/Trim Material
97843	6 in x 16 in West Coast Mirror Heads, 7 in x 16 in West Coast Mirror Heads	West Coast Rigid Bracket Universal	Silver	Steel

MOUNTING BRACKET

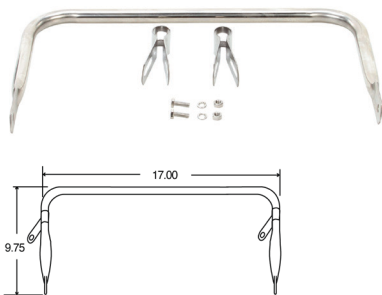

SAFETY YOKE BRACKET

FEATURES

- Adds swing away feature to any West Coast assembly
- Provides protection against damage in tight spots
- Comes complete with mounting clamps



Part Number	Compatible Parts	Mount Type	Mount/Trim Color	Mount/Trim Material
97725		Yoke	Silver	Steel
97726		Yoke	Black	Steel

SAFETY YOKE BRACKET

SCHOOL BUS FENDER BRACKET



FEATURES

- Black painted steel
- Extends 13"-25" after mounting
- Can be used with any ball stud convex mirror

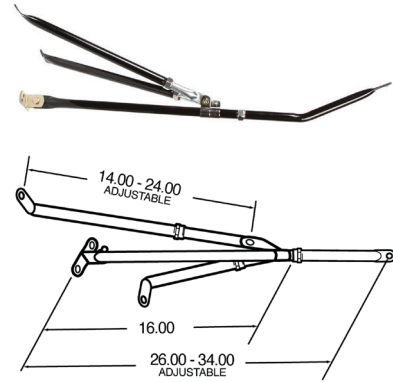

Part Number	Compatible Parts	Mount Type	Mount/Trim Color	Mount/Trim Material
97666	Convex Mirrors	Tripod Bracket	Black	Steel

BELL MOUNT BRACKET FOR CONVEX MIRROR HEADS



FEATURES

- Features heavy-duty stainless steel construction
- Single extension-arm mounts to most fiberglass, steel or aluminum fenders
- For use with 6" or smaller convex mirror heads or added support to other brackets
- Bell mount design includes 3" plastic washers to prevent damage to fiberglass fenders

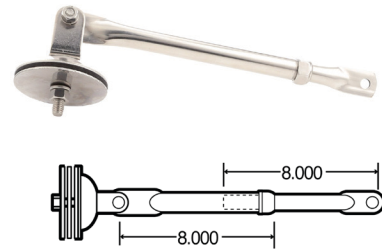

Part Number	Compatible Parts	Mount Type	Mount/Trim Color	Mount/Trim Material
97828	6 in or Smaller Convex Mirror	Fixed Mounting Arm	Silver	Steel
97829	Convex Mirrors	Tripod Bracket Universal	Silver	Steel

L BRACKET



FEATURES

- For convex mirrors
- For use with 5"-8-1/2" convex mirror heads



Part Number	Compatible Parts	Mount Type	Mount/Trim Color	Mount/Trim Material
97718	5 in to 8-1/2 in Convex Mirror Heads	Bracket Mount	Silver	Stainless Steel

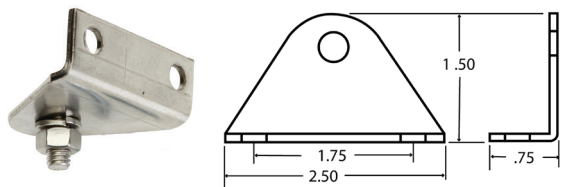

90° MOUNTING BRACKET

FEATURES

- Small 90-degree standard mounting bracket
- Stainless steel
- Door mount bracket for 97727 and 97843 mirror arm assemblies and 97633 and 97694 west coast mirror assemblies
- Mounting: 1-3/4" centers



Part Number	Compatible Parts	Mount Type	Mount/Trim Color	Mount/Trim Material
97876	Mirror Arm Assembly (97843), West Coast Mirror Assembly (97633, 97694)	90 Degree Mounting Arm	Silver	Steel



EXTENDER BRACKET

FEATURES

- Extends 10"-16
- Black painted steel



Part Number	Compatible Parts	Mount Type	Mount/Trim Color	Mount/Trim Material
97719		180 Degree Mounting Arm	Black	Steel

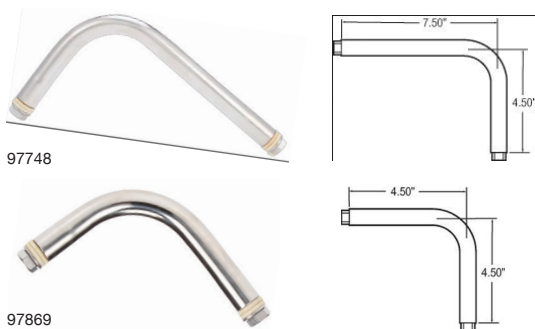

OFFSET ELBOW EXTENSION FOR TRIPOD MIRROR ASSEMBLIES

FEATURES

- Replacement elbow for 97861 mirror
- Provides vertical extension for tripod mounted mirrors



Part Number	Compatible Parts	Mount Type	Mount/Trim Color	Mount/Trim Material
97748	Large Rectangular Mirror Head (97805)	Tripod Bracket	Silver	Steel
97869		Tripod Bracket	Silver	Steel



EXTENSION ARM

FEATURES

- For use in mounting convex mirrors to "below eye level" mirror assemblies
- 9-1/4" overall length, stainless steel
- Mounting on 8-1/4" centers



Part Number	Compatible Parts	Mount Type	Mount/Trim Color	Mount/Trim Material
97731	Convex Mirrors	180 Degree Mounting Arm	Silver	Stainless Steel

MOUNTING ARM

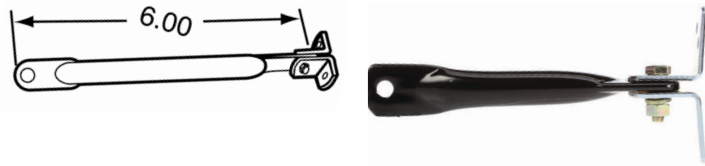

FEATURES

- 6" body mounting arm
- Black painted steel

Part Number	Compatible Parts	Mount Type	Mount/Trim Color	Mount/Trim Material
97720		90 Degree Mounting Arm	Black	Steel

UNIVERSAL SIDE CLAMP

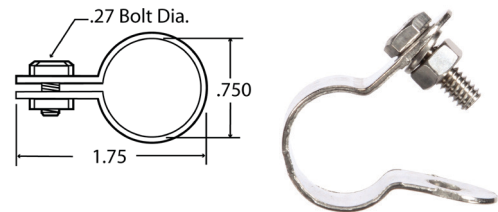

FEATURES

- Clamps onto 3/4" tubular arm
- Replacement for most west coast and tripod assemblies
- 1/4" holes

Part Number	Compatible Parts	Mount Type	Mount/Trim Color	Mount/Trim Material
97732	Signal-Stat 7928, Tripod Assembly, West Coast Mirror Assembly		Silver	Stainless Steel

HEAD CLAMP



FEATURES

- Single piece stainless steel clamp and hardware
- Clamp has plastic coating to protect painted surfaces

Part Number	Compatible Parts	Mount Type	Mount/Trim Color	Mount/Trim Material
97733			Silver	Stainless Steel

ADJUSTABLE MIRROR BRACE

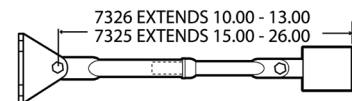

FEATURES

- 99721 extends from 15"-26"
- 99722 extends from 10"-13"
- Can be used as mirror bracket or brace with any convex or West Coast Mirror assembly
- Black painted steel

Part Number	Compatible Parts	Mount Type	Mount/Trim Color	Mount/Trim Material
97721	West Coast Mirror Assembly	180 Degree Mounting Arm	Black	Steel
97722	West Coast Mirror Assembly	180 Degree Mounting Arm	Black	Steel

HEATER ELEMENT

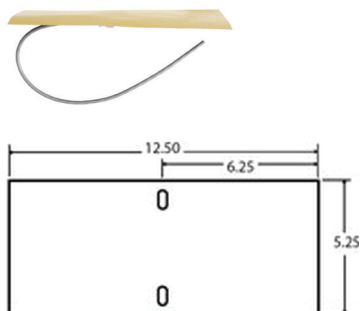

FEATURES

- Replacement heater element for West Coast mirrors
- Convert any West Coast mirror to a heated mirror head
- Improved temperature control limits the temperature to 145
- Replaces Signal-Stat 7930



Part Number	Compatible Parts
97845	Signal-Stat 7930, West Coast Mirror

HEATER ELEMENT

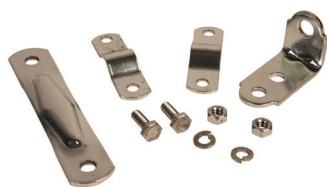

CONVEX MIRROR MOUNT

FEATURES

- Fits either 3/4" or 5/8" diameter tubing
- Attaches convex mirrors to other bracket with a two-part, clamshell style clamp
- Kit includes a 4-1/2" extension arm, and L-bracket, clamshell clamp pieces and hardware
- Replaces Signal-Stat 7941



Part Number	Compatible Parts	Mount Type	Mount/Trim Color	Mount/Trim Material
97823	Signal-Stat 7941		Silver	Steel

CONVEX MIRROR MOUNT



UNIVERSAL SIDE MOUNTING, KIT

FEATURES

- Fits either 3/4" or 5/8" diameter tubing
- Attaches convex mirrors to other bracket with a two-part, clamshell style clamp
- Kit includes a 4-1/2" extension arm, and L-bracket, clamshell clamp pieces and hardware
- Replaces Signal-Stat 7205



Part Number	Compatible Parts	Mount Type	Mount/Trim Color	Mount/Trim Material
97849	Convex Mirror Head		Black	Steel

SIDE MOUNTING KIT

REFLECTORS & REFLECTIVE TAPE

Category	Shape	Page
Reflectors		440-443
	ROUND	440-441
	OVAL	441-442
	RECTANGULAR	442-443
	HEXAGONAL	443
Reflective Tape		443-445
Warning Triangles		445

SIGNAL-STAT, ROUND, 2" ADHESIVE MOUNT, ACRYLIC



FEATURES

- Permanent adhesive backing
- Mounts on any clean flat surface
- Smaller diameter for applications where space is limited
- Replaces Truck-Lite 98008 series



Part Number	Reflector Color
45	Red
45A	Yellow

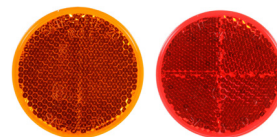

ROUND, 2" 1 SCREW, RIVET, ACRYLIC



FEATURES

- Fast, permanent installation with screw or rivet
- Designed to take extra force in center
- Use one #10 screw- 1/4" hole



Part Number	Reflector Color
52	Red
52A	Yellow

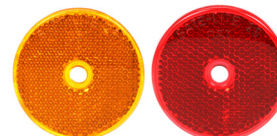

SIGNAL-STAT, ROUND, 3" ADHESIVE MOUNT, ACRYLIC



FEATURES

- Permanent adhesive backing
- Mounts on any clean flat surface
- Full diameter - 3.2"
- Replaces Truck-Lite 98005 series



Part Number	Reflector Color
47	Red
47A	Yellow
47DB	Red
47ADB	Yellow



ROUND, 3", ADHESIVE MOUNT, TAPE



FEATURES

- Economical, reduced labor costs, no time installing screw-on reflectors, molded reflectors
- Easy to apply—simply bend, peel and apply
- No drilling or mechanical fasteners needed
- Meets and exceeds DOT and SAE requirements
- Application temperature range 40 degrees to 100 degrees Fahrenheit

Part Number	Reflector Color	
98175RB	Red	Basket
98175R	Red	
98175YB	Yellow	Basket
98175Y	Yellow	

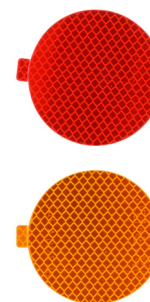

ROUND, 3", 1 SCREW, RIVET, ACRYLIC



- Fast, permanent installation with nail, screw or rivet
- Designed to take extra force in center
- Full diameter - 3.2"
- Use one #10 screw

Part Number	Reflector Color
98006C	Clear
98006R	Red
98006Y	Yellow

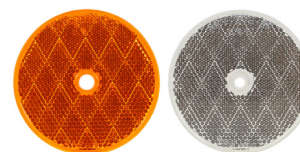



Part Number	Reflector Color	Mount/Trim Color
41	Red	Silver
41A	Yellow	Silver
43	Red	Silver
43A	Yellow	Silver

SIGNAL-STAT, ROUND, 3", 2 SCREW BRACKET MOUNT, ALUMINUM



FEATURES

- With 3" reflector and protective guard
- Replaces Truck-Lite 98030 Series



Part Number	Reflector Color	Mount/Trim Color
57	Red	White
57A	Yellow	White

SIGNAL-STAT, ROUND, 3.5", 1 SCREW, ABS



FEATURES

- 3.5" SAE Class A reflector hermetically sealed
- Designed for heavy OEM applications
- Can be used on trucks, trailers and other on and off road applications
- Molded insert for center-mount screw prevents cracking
- Use one #10 screw- .218" hole

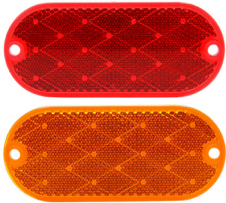

Part Number	Reflector Color
98031R	Red
98031Y	Yellow

OVAL, 2"X4", 2 SCREW, ACRYLIC

FEATURES

- 98031R/Y version is mounted with two screws

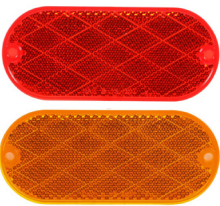

Part Number	Reflector Color
54	Red
54A	Yellow

OVAL, 2"X4", 2 SCREW, ADHESIVE MOUNT, ACRYLIC



FEATURES

- Can be used as stick-on by peeling off back paper or can be mounted with two screws

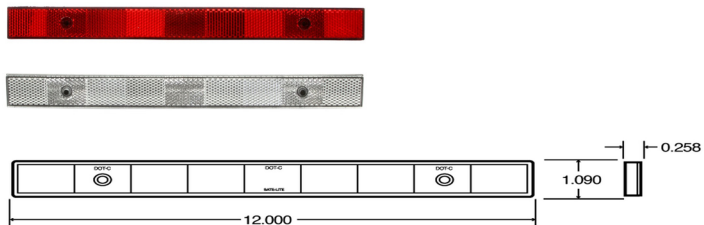

**RECTANGLE, 2 SCREW,
ADHESIVE MOUNT, ACRYLIC**

Part Number	Reflector Color	Size
98153	Clear	1in x 12in
98154R	Red	1in x 12in
98155	Clear	1in x 11in



FEATURES

- Meets requirements of final NHTSA ruling - see Federal Regulations Charts for details
- Ideal for use in areas where mounting clearance is limited
- Adhesive backing or screw-on mounting
- Hermetically sealed construction
- 11" version has optics

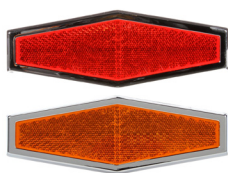

Part Number	Reflector Color	Mount/Trim Color
98033R	Red	
98033Y	Yellow	
98034R	Red	Chrome
98034Y	Yellow	Chrome

**HEXAGON, 2"X5",
ADHESIVE MOUNT, ACRYLIC**

FEATURES

- Mounts with adhesive backing

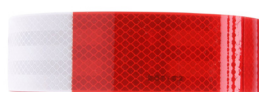

RED|WHITE



WHITE

Part Number	Reflector Color	Size
98100	White	2"x150"
98101	Red White	2"x150'
98102	Red White	3"x150'
98104	Red White	2"x18"
98105	White	2"x12"
98107	Red White	1.5"x150'
98108	Red White	2"x54"
98113	Red White	2"x2'

FEATURES

- Premium grade, durable and rigid non-corroding conspicuity marking tape resistant to weather, dirt, aging and cracking
- Tough, durable film prevents lifting to look like new, with aggressive adhesion to last long after application
- Typically 1,000 candle power (white) for maximum long side detection distance performance, exceeding minimum requirements by four times
- Vivid, bright white color assures maximum reflectivity and superior daytime color, blending nicely with trailer skin
- Impact resistant, withstanding a blow from a forklift or loading dock and still retro-reflects
- Exceeds NHTSA specifications
- Reflects light at all application angles on the roadway
- Quick application with an easy-release liner

**PREMIUM REFLECTIVE
MARKING TAPE**

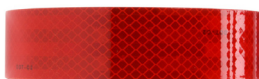

RED



RED|WHITE



WHITE

Part Number	Reflector Color	Size
98111	Red	2"x150'
98126	White	2"x150'
98127	Red White	2"x150'
98136	Red White	2"x18"
98137	White	2"x12"
98138	Red White	2"x54"
98144	Red White	2"x48'
98146	Red White	2"x150'

**STANDARD REFLECTIVE
MARKING TAPE**

FEATURES

- Tough, durable films resists cracking and lifting to look like new, long after application
- .010 thin tape with no open cell construction
- Typically 600 candle power for maximum long side detection distance performance, exceeding minimum requirements by 2.5 times
- Impact resistant, withstanding a blow from a forklift or loading dock and still retro-reflects
- Reflects light at all application angles on the roadway



REFLECTIVE TAPE MARKING TAPE



Part Number	Reflector Color	Size
98139	Red White	2"x100'
98180	Red White	2"x50'



RED|WHITE

FEATURES

- Tough, durable films resists cracking and lifting to look like new, long after application
- 98180 - .008 thick tape with no open cell construction
- 98139 - .010 thick tape with no open cell construction & Impact resistant, withstanding a blow from a forklift or loading dock and still retro-reflects
- Exceeds FHWA specifications
- Reflects light at all application angles on the roadway

ECOMONY REFLECTIVE MARKING TAPE



Part Number	Reflector Color	Size
37	Red White	2"x150'



RED|WHITE

FEATURES

- Tough, durable film prevents lifting to look like new, with aggressive adhesion to last long after application
- .010 thin tape with no open cell construction
- Impact resistant, withstanding a blow from a forklift or loading dock and still retro-reflects
- Exceeds FHWA specifications with DOT-C2 markings
- Reflects light at all application angles on the roadway

SCHOOL BUS PREMIUM REFLECTIVE MARKING TAPE



Part Number	Reflector Color	Size
98165	School Bus Yellow	2"x150'
98167	School Bus Yellow	1"x150'



SCHOOL BUS YELLOW

FEATURES

- Meets all DOT requirements
- Thin, single layer construction
- No open cells that could allow tape to degrade with moisture and dirt intrusion
- Flat back allows for 100% adhesive contact
- Will not crack, peel or delaminate
- Withstands repeated power washings



SCHOOL BUS YELLOW

SCHOOL BUS STANDARD REFLECTIVE MARKING TAPE

Part Number	Reflector Color	Size
98168	School Bus Yellow	2"x150'
98170	School Bus Yellow	1"x150'



FEATURES

- Meets all DOT requirements
- Thin, single layer construction
- No open cells that could allow tape to degrade with moisture and dirt intrusion
- Flat back allows for 100% adhesive contact
- Flexible, can bend 180 degrees or more with no cracking
- Will not crack, peel or delaminate
- Withstands repeated power washings

REFLECTIVE TAPE

SCHOOL STANDARD



798



799

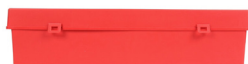
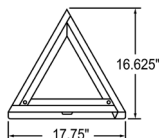

794

FOLDABLE WARNING TRIANGLE



TRIANGLE FEATURES

- Provides an added measure of safety for stranded motorists
- Comes complete with its own protective carrying case

KIT/BOX FEATURES

- Meets FMVSS 125 standards
- Triangle unfolds and locks together
- Non-skid heavy base withstands strong winds
- Reflex reflector strips form border for nighttime visibility - fluorescent orange inner triangle for daytime warning
- Housed in strong, heavy-duty box - 18" X 4" X 4-1/2"
- Shipped in individual corrugated box for added measure of protection
- Replaces Truck-Lite 97974

Part Number	Mount Type	Kit	Replacement Part
798	Free-Standing	Yes	
794			Box

WARNING TRIANGLE

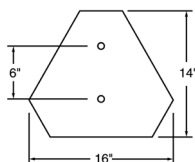

FEATURES

- Durable ABS material will not fade or rust
- Meets ANSI and ASAE standards S-276.5 for slow moving vehicles
- For agricultural vehicles, construction equipment and industrial vehicles

FIXED WARNING TRIANGLE



Part Number	Mount Type
797	2 Bolt & Nut Mount

WARNING TRIANGLE

MAINTENANCE

Category	Type	Page
Anti-Corrosion Compound		450
	NKY-77	450
	MULTI-PURPOSE MAINTENCANCE SPRAY	450
Tester Kits & Accessories		451-452
Light Repair Kits		453



Maintenance Products

Whether it's our tried-and-true NYK-77 corrosion preventive compound or the all-new nano™ series of dielectric products, Truck-Lite has your lights and electrical systems covered.

Products

NYK-77 family, Multi-Purpose Maintenance Spray, nanoSeal, nanoShell

Sizes and applications

Truck-Lite's corrosion-preventative and dielectric compounds are available in a variety of sizes for a variety of applications.

NYK-77

Trusted for over 40 years, and used daily in our production facilities, NYK compounds prevent corrosion for electrical contacts, switches and junction boxes.









8oz can • 32oz can • 2oz tube • 5oz tube • 14oz cartridge

Multi-Purpose Maintenance Spray

It's right in the name. Our MPMS lubricates, prevents and removes corrosion and cleans and penetrates, invading hard-to-reach crevices and tight seams. It also displaces moisture and provides dielectric protection – a dynamic addition to any toolbox.

14oz spray can

(800) 562-5012 | truck-lite.com



 <p>Manufacturing & Quality</p>	 <p>Testing & Safety</p>
<p>Truck-Lite's range of dielectric products are overengineered to ensure the best protection for a vehicle's electrical system.</p>	<p>Truck-Lite maintenance products are exposed to strenuous environmental lab testing to ensure that they stand up to the harshest elements on the road.</p>
 <p>Performance & Maintenance</p>	 <p>Customer Support</p>
<p>NYK-77</p> <ul style="list-style-type: none"> • Specially formulated non-conductive sealant for all types of contacts and switches • High dielectric insulation against electrolysis <p>MPMS</p> <ul style="list-style-type: none"> • Maintains lubricity under high loads for superior reduction of friction, heat and noise • High dielectric insulation against electrolysis 	<div data-bbox="890 1171 957 1249">  </div> <p>Customer Service</p> <p>(800) 562-5012 customerservice@truck-lite.com</p> <div data-bbox="884 1396 960 1474">  </div> <p>Technical Support</p> <p>(888) 562-5012 tltech@truck-lite.com</p> <div data-bbox="874 1705 1305 1747"> <p>Maintenance Warranties</p> </div> <div data-bbox="874 1780 1098 1873">   </div>
<p>(800) 562-5012 truck-lite.com</p>	

NYK-77, CORROSION PREVENTATIVE COMPOUND



FEATURES

- Corrosion preventive compound for electrical contacts, switches and junction boxes
- For periodic use with all electrical contact not using Fit 'N Forget connectors
- Available in a variety of sizes

Part Number	Container Type	Container Volume	
97940	Can	8 oz	
97943	Can	32 oz	
97944	Tube	2 oz	
98013	Tube	5 oz	
97948	Cartridge	14 oz	

MULTI-PURPOSE MAINTENANCE SPRAY



FEATURES

- Quickly loosens frozen or seized parts
- Invades hard-to-reach crevices and creeps through the tightest seams
- Displaces moisture
- Corrosion Control: Forms a protective thin film barrier to stop oxidation and prevent rust from spreading
- Dissolves corrosion oxide - stops rust on contact
- Maintains lubricity under high loads for superior reduction of friction, heat and noise
- Use on fifth wheel springs and rails, glad hands, control linkages, roll-up doors, hinges and latches, chains and pulleys and more
- Highperformance penetrant
- Prevents and removes corrosion build-up
- High dielectric insulation against electrolysis
- Extreme pressure lubricant
- For use on connectors including ABS, 4-13 way plugs and sockets, battery terminals and more



Part Number	Container Type	Container Volume
97946	Can	14 oz



96260



96259

LIGHT TEST, KIT

Part Number	Power Supply
96260	No
96259	Yes



LIGHT TEST KIT

FEATURES

- Quickly checks functions of Truck-Lite LED and incandescent lamps
- Includes durable zipper bag to conveniently store included parts



POWER SUPPLY

Part Number
96257



POWER SUPPLY



WIRE LEAD

FEATURES

- Can be used with all Truck-Lite sealed incandescent lamps and wiring systems
- In conjunction with 97100

Part Number
97282



WIRE LEAD

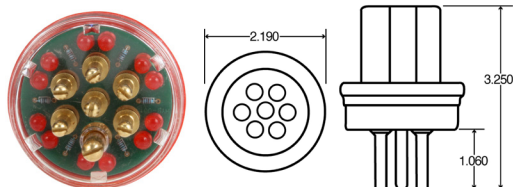

TRAILER CABLE & CIRCUIT TESTER

FEATURES

- Compliment to the lamp and circuit tester
- Uses high quality brass pins for reliable contact
- LEDs quickly identify faulty circuits in either of the connector cord assembly or the tractor
- Designed for use with 12 or 24 volt systems and negative or positive ground vehicles

Part Number
97101



CABLE & CIRCUIT TESTER



TERMINAL CONNECTOR CLEANER MASTER

FEATURES

- For male and female connections
- For tail and side marker light assemblies
- Maintain continuity and prevent circuit failure
- Quickly and precisely cut away corrosion

Part Number
96193



CLEANER MASTER

STORAGE BAG

STORAGE BAG



Part Number
96258



POUCH

POUCH



FEATURES

- All weather protection for permits, licenses and inspection stickers

Part Number
50



DOCUMENT HOLDER

DOCUMENT HOLDER KIT



Part Number	Color	Kit Components
97960	Clear	97962 gasket
97960-3	Clear	97962 gasket
97799	Grey	97798 cover with gasket

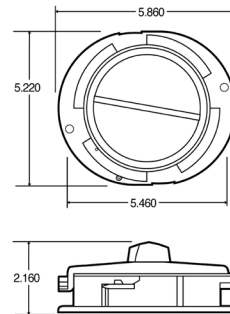

ROADSIDE REPAIR

ROADSIDE REPAIR KIT LED



FEATURES

- Contains items needed to replace a malfunctioning S/T/T or M/C lamp with minimal vehicle down-time
- Truck-Lite LED Flex-Lite marker lamps can retrofit many common marker lamp installation with ease, thanks to a simple peel-and-stick adhesive backing
- Includes Truck-Lite Super 44 Series LED S/T/T lamp, with an accommodating PL-3 adapter plug
- Additional wiring accessories include a multi-purpose wire cutter/stripper, high-quality butt-splice connectors and Truck-Lite NYK-77 corrosion-preventive compound



Part Number	Kit Includes
97392	96258-storage bag 97388-crimp tool 97389-12/10 ga. butt splice connectors x3 97390-16/14 ga. butt splice connectors x3 97389-12/10 ga. butt splice connectors x3 97391-18/16 ga. butt splice connectors x3 44302R-LED Super 44 series s/t lamp 40700-grommet mount 94706-fit forget LED-to-PL3 adapter 36100R/36100Y-LED 36 series flex-lite m/c lamp 97944-nyk77 compound, 2oz. tube



ROADSIDE REPAIR KIT INCANDESCENT

FEATURES

- Contains items needed to replace a malfunctioning S/T/T or M/C lamp with minimal vehicle down-time.
- Includes Truck-Lite 40282R Economy 40 S/T/T Lamp.
- Additional wiring accessories include a multi-purpose wire cutter/stripper, high-quality butt-splice connectors and Truck-Lite NYK-77 corrosion-preventive compound.



Part Number	Kit Includes
97382	96258-storage bag 97388-crimp tool 97389-12/10 ga. butt splice connectors x3 97390-16/14 ga. butt splice connectors x3 97389 12/10 ga. butt splice connectors x3 97391-18/16 ga. butt splice connectors x3 10201R/10201Y-10 series 2.5" m/c lamp 30200Y/30200R-30 series m/c lamp 19200R/19200Y-19 series m/c lamp 19721-19 series grey mount & hot wire 10700-10 series grommet 30700-30 series grommet 94902-.5" m/c plug with #5 ground terminal x2 40282R-eco 40 series s/t/t lamp 40700-grommet mount 97944-nyk77 compound, 2oz. tube

ROADSIDE REPAIR



CABLE CLAMP REPAIR, KIT

Part Number
87845



CABLE CLAMP



WIRE CRIMPER



Part Number
77825

FEATURES

- For use with field-installable terminals 97983 and 97984



WIRE CRIMPER, CUTTER, & STRIPPER



Part Number
97388

FEATURES

- Multi-purpose crimp tools

CRIMPER/CUTTER/STRIPPER



ELECTRICAL HARNESS SERVICE CRIMPER KIT

Part Number	Materials
97851	Heat-treated, high-tempered steel



FEATURES

- Easy handling
- Precise radial closing motion/guide tracking ensures a high-quality application
- Interchangeable crimp dies: easy and accurate exchange and positioning of the crimp die sets
- Releasable ratchet ensures a complete crimp process
- Suitable for crimping new super seal connectors (94766)

SERVICE TOOL

ALARMS & SWITCHES

Category	Series	Page
BACK-UP ALARMS		456-459
	Bracket Mount	456-458
	Grommet Mount	458
	Socket Mount	459
BACK-UP SWITCHES		459
TURN SIGNAL SWITCHES		459-465
	Douglas Autotech	460
	Ford	460
	Freightliner	460
	Ford / Freightliner	461
	GMC / Euclid / Hitachi	461
	Kenworth	461
	Mack	461
	Navistar	462
	Tennant	462
	Peterbilt	463
	Volvo	463
	Volvo / GMC	463
	2 Wire Harness	463
	4, 6, 7, 10 Wire Harness	464
	Self-Cancelling	465
	Switch Handle	463
	2 Position	465
Universal Switches		465
	ATL-DRL Switch	465
	Blade Terminal	465

MULTI-FREQUENCY, SELF ADJUSTING, BRACKET MOUNT



FEATURES

- Uses multi-frequency, narrow-band technology
- Unique sound is perceived to dissipate quickly
- Encapsulated electronics extend product life - sealed in epoxy to protect against dust, moisture and vibration
- "Narrow-band" technology
- Meets J994 Type C requirement
- Operates by emitting sound at multiple frequencies about 4,000Hz so sound dissipates more quickly than pure-tone alarm

Part Number	DB Level Min	Housing Material	Connection	Volts	Steam Cleanable	Standards Met	Steam Cleanable
92934	107	Glass Nylon	Stripped End	12 24	Yes	J994	Yes

MULTI-FREQUENCY, 2 SCREW BRACKET MOUNT

FEATURES

- Uses multi-frequency, narrow-band technology
- Unique sound is perceived to dissipate quickly
- Encapsulated electronics extend product life - sealed in epoxy to protect against dust, moisture and vibration
- "Narrow-band" technology
- Meets J994 Type C requirement
- Operates by emitting sound at multiple frequencies about 4,000Hz so sound dissipates more quickly than pure-tone alarm
- Compact size and universal mounting bracket maximizes location options



92932

92933

Part Number	DB Level Min	Housing Material	Connection	Volts	Steam Cleanable	Standards Met	Steam Cleanable
92932	87	Glass Nylon	Stripped End	12 24	Yes	J994	Yes
92933	97	Glass Nylon	Stripped End	12 24	Yes	J994	Yes

SINGLE-SOUND, SELF-ADJUSTING, 2 SCREW BRACKET MOUNT

FEATURES

- 92910 specifically designed low sound level alarm for electric powered vehicles
- Compact
- Solid state electronics
- Steam cleanable
- Meets J994 Type C requirement
- U-L recognized for electric vehicle and forklifts
- 92911 Adjusts automatically to environmental noise

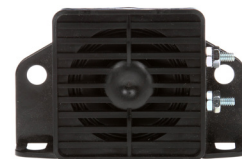
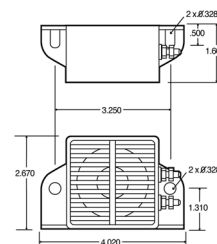

Part Number	DB Level Min	DB Level Max	Housing Material	Lamp Connection	Volts	Steam Cleanable	Standards Met	Warranty
92900	97		Glass Nylon	2 Bolt Terminal	12	Yes	J994	2 Year
92901	97		Glass Nylon	2 Bolt Terminal	12 24	Yes	J994	2 Year
92902	102		Glass Nylon	2 Bolt Terminal	12 24	Yes	J994	2 Year
92910	97		Glass Nylon	2 Bolt Terminal	12 24 36 48	Yes	J994	2 Year
92911	77	107	Glass Nylon	2 Bolt Terminal	12 24	Yes	J994	2 Year

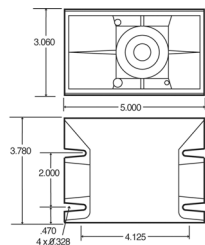

SINGLE-SOUND, SELF-ADJUSTING, 4 SCREW BRACKET MOUNT,

FEATURES

- Sealed solid state electronics
- Meets OSHA, SAE J994 Type A-D, Bureau of Mines and all state regulations
- Steam cleanable
- Operating temperatures range from -40°F to 170°F
- UNC terminal studs #8-32
- 92905 Adjusts automatically to environmental noise

Part Number	DB Level Min	DB Level Max	Housing Material	Lamp Connection	Volts	Steam Cleanable	Standards Met	Warranty
92903	107		Glass Nylon	2 Bolt Terminal	6 36	Yes	J994	2 Year
92904	112		Glass Nylon	2 Bolt Terminal	6 36	Yes	J994	2 Year
92905	87	112	Glass Nylon	2 Bolt Terminal	6 36	Yes	J994	2 Year

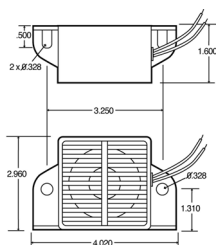

SINGLE-SOUND REGULATION, 2 SCREW BRACKET MOUNT, HARDWIRED

FEATURES

- Compact high sound level alarm
- Sealed solid state electronics with polarity protection
- Approximate .5 amp current draw
- Self-resonating circuit board automatically adjusts to environmental conditions to ensure a constant output
- Standard terminal studs are replaced by 12" length, 18 gauge wire leads

Part Number	DB Level Min	Housing Material	Lamp Connection	Volts	Steam Cleanable	Standards Met	Warranty
92924	107	Glass Nylon	Hardwired	12 24	No	J994	2 Year

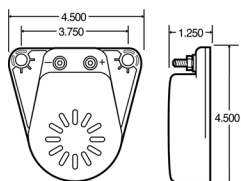

SINGLE-SOUND REGULATION 2 SCREW BRACKET MOUNT,

FEATURES

- Single sound back-up alarm for light to medium duty use
- Features epoxy sealed solid state electronics and a rigid PVC plastic housing
- Connections are made with two #8-32 UNC terminal studs
- Meets OSHA, SAE J994, Bureau of Mines and all state regulations

Part Number	DB Level Min	DB Level Max	Housing Material	Lamp Connection	Volts	Steam Cleanable	Standards Met	Warranty
92909	97		PVC	2 Bolt Terminal	12	No	J994	2 Year

SINGLE SOUND REGULATION, 4 SCREW BRACKET MOUNT,

FEATURES

- Adjusts automatically to environmental noise, reducing irritation for operators and workers
- Meets OSHA, SAE J994 Bureau of Mines Type B/C and all state regulations
- Sealed solid state electronics
- Steam cleanable
- Operating temperatures range from -40 degrees to +170 degrees F

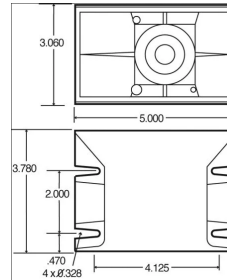

Part Number	DB Level Min	DB Level Max	Housing Material	Lamp Connection	Volts	Steam Cleanable	Standards Met	Warranty
92923	97	107	Glass Nylon	3 Bolt Terminal	12 24	Yes	J994	1 Year

DUAL TONE ALARM, 4 SCREW BRACKET MOUNT

FEATURES

- Self adjusts automatically to produce 10 decibels nominal above surrounding noise
- Depending upon how power is applied, it can behave like a self-adjusting alarm or a pulsed warble sounding alarm
- Steam cleanable
- Operating temperatures range from -40F to + 170F
- UNC terminal studs #8-32

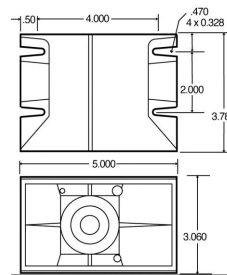

Part Number	DB Level Min	DB Level Max	Housing Material	Lamp Connection	Volts	Steam Cleanable	Standards Met	Warranty
92927	87	112	Glass Nylon	3 Bolt Terminal	12-48	Yes		2 Year

SELF ADJUSTING SOUND REGULATION, 4" ROUND, GROMMET MOUNT

FEATURES

- Features a urethane-filled housing to protect the alarm from moisture, dust and vibration
- Alarm is flush mounted to help protect against road debris, salt and mud
- No additional tools required for installation or replacement
- Uses industry standard grommets and pigtailed
- Steam cleanable
- Voltage spike protected
- Meets OSHA, SAE J994, Bureau of Mines and all state regulations
- Operating temperatures range from -40 F to +170 F
- 92914 Adjusts automatically to environmental noise

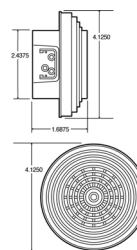

Part Number	DB Level Min	DB Level Max	Housing Material	Lamp Connection	Volts	Steam Cleanable	Standards Met	Warranty
92914	77	97	PC	PL-3	12 24 36 48	Yes	J994	2 Year
92916	97		PC	PL-3	12	Yes	J994	2 Year
92918	102		PC	PL-3	12 24	Yes	J994	2 Year

BACK-UP SAFETY BULB AND ALARM, SOCKET MOUNT, SINGLE SOUND REGULATION



328D



329D

FEATURES

- Combination back-up safety device and lamp
- Provides a clear 87dB "beep, beep" when vehicle is put into reverse gear
- 20 watt halogen bulb provides greater light output when vehicle is in reverse
- Perfect for cars, school busses, vans, RVs and light trucks

Part Number	DB Level Min	DB Level Max	Housing Material	Lamp Connection	Volts	Steam Cleanable	Warranty
328D	87		Aluminum	Bayonet Base	12	No	2 Year
329D	87		Aluminum	Wedge Base	12	No	2 Year

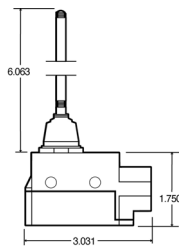
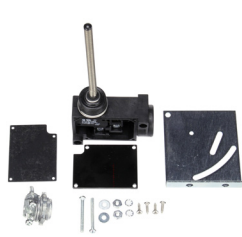

BACK-UP ALARM SWITCH

FEATURES

- A water-resistant switch with a 5 amp rating
- Arm operates with a full 360-degree movement
- For use when a back-up light circuit is not available to activate the alarm
- For increased water resistance, an optional 3/8" ID water tight compression fitting is available and will accommodate a 2-conductor round cable
- UL and CSA approved

Part Number	Housing Material	Lamp Connection	Volts	Steam Cleanable	Warranty
92925	Plastic	3 Screw Terminal	12-80	No	1 Year
92907	Zinc	3 Screw Terminal	12-80	No	1 Year

3/8" ID WATER TIGHT COMPRESSION FITTING
97003



BACK-UP ALARM SWITCH



FEATURES

- 80594 Illuminating rocker switch
- On-off switch for use with auxiliary lights and heated mirrors





Part Number
80594



DOUGLAS AUTOTECH

	Part Number	OEM Number	Plug Side 2	Replacement Part No.
	960Y101		6 Way Packard Connector 12015345, Packard Connector 02973778, Packard Connector 12015344, Packard Connector 12015987, Packard Connector 12047781	49916, 49916A
	962Y102		6 Way Packard Connector 06288700, Packard Connector 2973778, Packard Connector 08905650	50118, 50118A



FORD

	Part Number	OEM Number	Plug Side 2	Replacement Part No.
	90251		Ford 14 Way Connector, Packard Connector 12015345	F7HT-13B302-DA, F6HT-13B302-AC, F8HT-13B302-BA
	915Y128		6 Pin Ford Connector, 2 Position .180 Bullet Terminal	F0HS13B302BA

FREIGHTLINER

	Part Number	OEM Number	Plug Side 2	Replacement Part No.
	90251Y103		Ford 14 Way Connector, Packard Connector 12015345	A06-32389-000
	915Y119		6 Pin Ford Connector, 2 Position .180 Bullet Terminal	E8HS13B302AA
	915Y113		6 Way Packard Connector 12015345, Packard Connector 12047781, Packard Connector 12015987, Packard Connector 2973778	A06-13867-002, A06-17126-000

FORD / FREIGHTLINER

	Part Number	OEM Number	Plug Side 2	Replacement Part No.
	900Y180		6 Pin Ford Connector	F0HZ-13441-E, F0HT13B302AB
	900Y170		6 Pin Ford Connector	E5HT13B302AA, E5HZ13341A
	900Y179		6 Pin Ford Connector	FOHT13B302AB

FORD / FREIGHTLINER

GMC / EUCLID / HITACHI

	Part Number	OEM Number	Plug Side 2	Replacement Part No.
	900Y166		8 Blade Connector	15500336, E4071125, E4071126



GMC / EUCLID / HITACHI

KENWORTH

	Part Number	OEM Number	Plug Side 2	Replacement Part No.
	915Y103		Packard Connector 6288700, Packard Connector 2984883	18500D044, K301D230











KENWORTH

MACK

	Part Number	OEM Number	Plug Side 2	Replacement Part No.
	900Y73		8 Blade Packard Connector 2969789	1MR2201P2, 1MR2201P1, 1MR3412P2, 1MR3412P1
	900Y209		6 Blade Packard Connector 6288700	K301D182

MACK



NAVISTAR

	Part Number	OEM Number	Plug Side 2	Replacement Part No.
	900Y114		6 Blade Packard Connector 6288700	775863C93
	900Y206		Packard Connector 6288700	1663595C91
	960Y100		6 Way Packard Connector 12015345, Packard Connector 2973779, Packard Connector 12015344, Packard Connector 12015987, Packard Connector 12047781	2042616C91, 3566945C91
	961Y100		6 Way Packard Connector 12015345, Packard Connector 02973778, Packard Connector 12015344, Packard Connector 12015987, Packard Connector 12047781	2042615C91, 3566944C91
	962Y100		6 Way Packard Connector 06288700, Packard Connector 2973778, Packard Connector 08905650	2002874C91, 3566935C91
	962Y101		6 Way Packard Connector 06288700, Packard Connector 2973778, Packard Connector 08905650	2034257C91, 3566941C91
	963Y100		6 Way Packard Connector 12015345, Packard Connector 12047781, Packard Connector 12015987, Packard Connector 2973778	2002875C91, 3566936C91
	963Y101		6 Way Packard Connector 12015345, Packard Connector 2973779, Packard Connector 12015344, Packard Connector 12015987, Packard Connector 12047781	2007932C91, 3566939C91
	963Y102		6 Way Packard Connector 12015345, Packard Connector 12047781, Packard Connector 12015987, Packard Connector 2973778	2042614C91, 3566943C91
	964Y100		6 Way Packard Connector 12015345, Packard Connector 2973779, Packard Connector 12015344, Packard Connector 12015987, Packard Connector 12047781	2042613C91, 3566942C91

TENNANT

	Part Number	OEM Number	Plug Side 2	Replacement Part No.
	900Y205		Stripped End	60750

PETERBILT

	Part Number	OEM Number	Plug Side 2	Replacement Part No.
	915Y104		Packard Connector 2973890, Packard Connector 2973385	16-03827
	915Y114		Packard Connector 6288700, Packard Connector 2984883	16-4415
	915Y124		Packard Connector 6288700, Packard Connector 2984883	16-4415



PETERBILT

VOLVO

	Part Number	OEM Number	Plug Side 2	Replacement Part No.
	915Y105		Packard Connector 2977044	84401-3203

VOLVO

VOLVO / GMC

	Part Number	OEM Number	Plug Side 2	Replacement Part No.
	915Y116		Packard Connector 2977044	3081534, 3081534
	915Y117		Packard Connector 2977044	3081533, 3081534

VOLVO / GMC

	Part Number	Plug Side 2
	102	Stripped End



TURN SIGNAL SWITCH,
2 WIRE HARNESS

FEATURES

- Illuminated knob
- Meets SAE specifications
- Mounts through 5/8" diameter hole in dashboard
- Two wire connection
- Single pole normally open circuit
- 20 amps @ 12 VDC

2 WIRE HARNESS

TURN SIGNAL SWITCH, 4 WIRE HARNESS

	Part Number	Plug Side 2	Color
	902	Stripped End	Black
	903	Stripped End	Chrome

FEATURES

- Exceeds J589 and J910 standard for turn signals and hazard functions
- 4 wire harness
- Pilot light for turn signal and hazard warning
- use 3 terminal flasher
- 8 bulb capacity for hazard, 4 per side for turn signal flashing
- Can be used for 6 or 24 Volt applications by changing indicator bulb and flasher. 4 bulbs per side

TURN SIGNAL SWITCH, 6 WIRE HARNESS

	Part Number	Plug Side 2
	910	Stripped End

FEATURES

- Exceeds J589 and J910 standard for turn signals and hazard functions
- 6 Wire Harness
- Pilot Light internally wired use 2 Terminal flasher
- Heavy Load on Rear circuit
- 16 Bulb Capacity hazard , 8 per side for signal flashing

TURN SIGNAL SWITCH, 7 WIRE HARNESS

	Part Number	Plug Side 2
	900	Stripped End
	901	Stripped End
	920	Stripped End

FEATURES

- Exceeds J589 and J910 standard for turn signals and hazard functions
- 7 wire Switch.
- Pilot Light for signal and hazard warning
- 8 Bulbs Hazard, 4 per side for signal flashing
- Use 3 terminal flasher.

TURN SIGNAL SWITCH, 10 WIRE HARNESS

	Part Number	Plug Side 2
	905	Stripped End, 5 Pin Connector

FEATURES

- 10 wire harness with relay
- Signal arm features built-in push button high/low beam selector switch
- 10 bulb capacity for hazard warning, 5 bulbs per side for signal flashing
- Recommended flasher 262 (not included)



	Part Number	Plug Side 2
	91002	6 Blade Packard Connector 6288700

SELF CANCELLING

FEATURES

- Surpasses SAE J589 and J910 standards for turn and hazard functions
- Improved light weight, housing and handle
- Capable of flashing 18 lamps in hazard mode (9 lamps per side for turn signal flashing)
- Features a sealed boot to eliminate dust intrusion
- Includes self-canceling feature
- 962 features a lift-to-dim/flash-to-pass

SELF CANCELLING

	Part Number	Plug Side 2	Speed
	91150	6 Way Packard Connector, Packard Connector 12047781	2
	91250	6 Way Packard Connector, Packard Connector 12047781	7



**SELF CANCELLING
2 & 7 SPEED**

FEATURES

- Exceeds J589 and J910 standard for Exceeds J589 and J910 standard for turn signals and hazard functions
- 2 Speed Wiper Switch
- Lift to Dim/ Flash to Pass
- Sealed boot for dust protection
- Self canceling
- 16 Lamps Hazard, 8 lamps per side Turn
- Brake Overrides hazard function
- Packard 6 Position Connector 12015344

SELF CANCELLING

SWITCH HANDLE

	Part Number	Plug Side 2
	9191	Connector 03-06-1011
	9196	

SWITCH HANDLE

2 POSITION

	Part Number	Plug Side 2
	131	Stripped End

FEATURES

- Push Button Switch
- 2 Position, On/ Off
- 15 Amps at 6 and 12 Volts
- Includes Water proof Boot 97977

2 POSITION



ATL-DRL SWITCH, HARDWARE, KIT

- DRL kit includes a switch and a heavy-duty flasher



Part Number	Kit Includes
80940	1 Grommet, 3 Splice, 2 Ball Mount, 1 Flasher Fuse, 2 Washer, 1 Switch, 2 Nut, 1 Handle Extension

ATL-DRL SWITCH

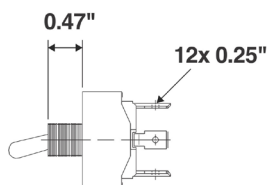

SWITCH, BLADE TERMINAL

Part Number
97224



TERMINAL

MERCHANDISING

Category	Page
Display Racks & Accessories	468-471
Lighted Displays	472-476
Shop Flood Cabinets	477

GONDOLA RACK

PEGBOARD GONDOLA RACK, WHITE



Part Number	H x W x D
97020	54" H x 48" W x 18.5" D

PEGBOARD GONDOLA RACK, BLACK

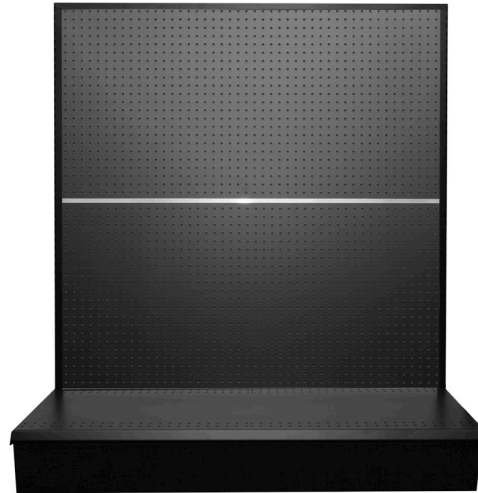

Part Number	H x W x D
97020B	54" H x 48" W x 18.5" D

GONDOLA RACK

SLAT GONDOLA RACK, WHITE



Part Number	H x W x D
97920	54" H x 48" W x 18.5" D

SLAT GONDOLA RACK, BLACK



Part Number	H x W x D
97920B	54" H x 48" W x 18.5" D

PEGBOARD END CAP, WHITE



Part Number	H x W x D
98020	54" H x 24" W x 14" D



PEGBOARD END CAP, BLACK

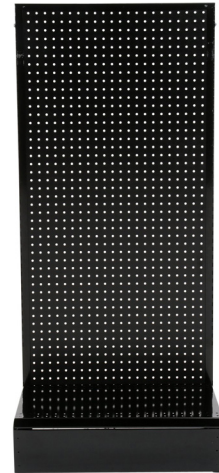

Part Number	H x W x D
98020B	54" H x 24" W x 14" D



END CAP



Part Number	Description
L4HEADER	4' Header



Part Number	Description
LENDCAPHEADER	2' End cap header

DISPLAY HEADERS

L4HEADER



LENDCAPHEADER



HEADERS

HOOKS & PEGS

PEGBOARD HOOKS



Part Number	H x W x D
97022	1.19" H x 1.31" W x 7" D

SLAT WALL HOOK



Part Number	H x W x D
97882	3.25" H x 1" W x 6.25" D

BASKET KIT

PEGBOARD BASKET, KIT



FEATURES

- Aesthetically pleasing, high-quality baskets
- Versatile configuration for customized product display

KIT INCLUDES:

- 1 basket
- 3 basket dividers (96197)
- 2 peg hooks (96198)



96198 PEG HOOK

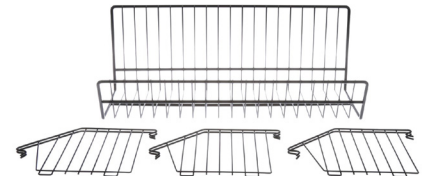

96196 BASKET / 96197 DIVIDER

Part Number	H x W x D	Replacement Parts
96199	10.88" H x 8.88" W x 23.75" D	96197 basket divider, 96198 peg hook

BASKET KIT

SLAT WALL BASKET, KIT



FEATURES

- Aesthetically pleasing, high-quality baskets
- Versatile configuration for customized product display

KIT INCLUDES:

- 1 basket
- 3 basket dividers (96197)
- 2 slat wall brackets (97883)



97883 SLAT WALL BRACKET

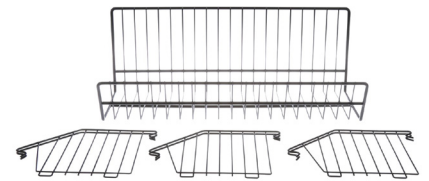

96196 BASKET / 96197 DIVIDER

Part Number	H x W x D	Replacement Parts
98000	8.88" H x 23.75" W x 8.51" D	96197 basket divider, 97883 slat wall bracket

END CAP SHELF

END CAP SHELF



Part Number	H x W x D
98021	1.5" H x 24" W x 10" D
98022	1.5" H x 24" W x 12" D

FOR USE WITH PEGBOARD END CAPS

- 90020 & 98020B



FRONT



SIDE

BASKET CARD/PRODUCT TAG

BASKET CARDS



FEATURES

- Cards have adhesive backing ideal for use on bin boxes
- Can be used with card clip (part# 97029) on front of baskets

Part Number	H x W x D
P340	1.75" H x 3.6" W
P440	2.13" H x 5.0" W

BASKET CARD PLASTIC CLIPS

PLASTIC CLIPS



FEATURES

- Display interchangeable product labels easily on Truck-Lite's product basket and bins

Part Number	H x W x D
97029	2" H x 5" W

BIN BOXES

BIN BOXES



FEATURES

- Easily organizw parts on a countertop or gondola

Part Number	H x W x D
97140	Small bin box (12"L x 4"W x 4.5" H)
97141	Medium bin box (12"L x 6"W x 4.5" H)
97142	Large bin box (12"L x 8"W x 4.5"H)

VINYL BANNERS

VINYL BANNER



Part Number	H x W x D
L48SM	2' x 3'

RE-ORDER TAGS

RE-ORDER TAGS



Part Number	H x W x D
97801	4" x 6.2"

**LED DISPLAYS,
MULTIPLE LIGHTS**



**97377 - TRUCK-LITE LED
LIGHTING DISPLAY**



**97376 - SIGNAL-STAT LED
LIGHTING DISPLAY**

FEATURES

- Display bases hang on a wall or gondola and can stand on a counter, shelf, or window exhibit
- All units have individually contained power supplies
- Sleek, clean, professional look to assist in product sales

Part Number	WxH	Included Lights
97377	24.25" H x 39.2" W	33250R, 33275Y, 36105R, 36110R, 36100Y, 36203Y, 36203R, 60425Y, 15205, 36140C, 33210C, 44281Y, 60421Y, 44302R, 66250R, 44350C, 66205C, 15250R, 19250Y, 21275Y, 30275R, 30270R, 30250Y, 10275R, 10385R, 10250Y
97376	24.25" H x 39.2" W	SS4558, SS4550A, SS4058A, SS6053, SS4050, SS6051A, SS4063C, SS6058, SS1560, SS1960A, SS2660, SS2150A, SS3050, SS3053A, SS3058, SS1053, SS1058A, SS1051

**LED DISPLAYS,
MULTIPLE LIGHTS INSERTS**



**97483 - TRUCK-LITE LED
LIGHTING DISPLAY INSERT**



**97482 - SIGNAL-STAT LED
LIGHTING DISPLAY INSERT**

Part Number	WxH	Included Lights
97483	16.73" W x 34.42" H	33050R, 33080Y, 33203R, 36115Y, 36105R, 36203Y, 36203R, 36110R, 36100Y, 44281Y, 44302R, 44350C, 15250R, 19250Y, 21275Y, 15041, 36042C, 60425Y, 33010C, 60421Y, 66250R, 66205C, 30275R, 30270R, 30250Y, 10275R, 10385R, 10250Y
97376	16.73" W x 34.42" H	4558, 4058A, 4050, 4063C, 1560, 1960A, 2660, 2150A, 4550A, 6053, 6051A, 6058, 3050, 3053A, 3058, 1053, 1058A, 1051

DISPLAY INSERT

LIGHTED MERCH DISPLAY



97381 - 7" ROUND LED HEADLIGHT DISPLAY



97383 - 4" X 6" LED HEADLIGHT DISPLAY



97405 - 5" X 7" LED HEADLIGHT DISPLAY

**LED DISPLAYS,
LED HEADLIGHT DISPLAYS**



FEATURES

- All units have individually contained power supplies
- Sleek, clean, professional look to assist in product sales
- All displays have ability to swap inserts

Part Number	WxH	Included Lights
97381	24.25" H x 17" W	27270C, 27275C
97383	24.25" H x 17" W	27645C, 27640C
97405	24.25" H x 17" W	27450C



97487 - 7" ROUND LED HEADLIGHT DISPLAY INSERT



97488 - 4" X 6" LED HEADLIGHT DISPLAY INSERT



97489 - 5" X 7" LED HEADLIGHT DISPLAY INSERT

**LED DISPLAYS,
LED HEADLIGHT INSERTS**



Part Number	WxH	Included Lights
97487	16.73" H x 12.23" W	27270C, 27275C
97488	16.73" H x 12.23" W	27645C, 27640C
97489	16.73" H x 12.23" W	27450C

LIGHTED MERCH DISPLAY

**LED DISPLAYS,
WORK LIGHTS**



FEATURES

- All units have individually contained power supplies
- Sleek, clean, professional look to assist in product sales
- Interchangeable lighted panels

Part Number	WxH	Included Lights
97378	24.25" H x 17" W	81500, 8160, 8140, 8180



DISPLAY INSERT

**LED DISPLAYS,
WORK LIGHTS, INSERT**



Part Number	WxH	Included Lights
97484	16.73" H x 12.23" W	81500, SS8160, SS8140, SS8180



LIGHTED MERCH DISPLAY

**LED DISPLAYS,
MARKER/CLEARANCE, LICENSE LIGHT**



FEATURES

- All units have individually contained power supplies
- Sleek, clean, professional look to assist in product sales
- Interchangeable lighted panels

Part Number	WxH	Included Lights
97380	24.25" H x 17" W	33250R, 33250Y, 33275R, 33275Y, 33210C, 33203R, 33260B, 33260G, 33260C, 33260PR, 33260R, 36105R, 36115Y, 36100Y, 36110R, 36203R, 36203Y, 36140C, 36145C



LED DISPLAYS, MARKER/CLEARANCE & LICENSE LIGHT, INSERT



Part Number	WxH	Included Lights
97486	16.73" H x 12.23" W	33250R, 33250Y, 33275R, 33275Y, 33210C, 33203R, 33260B, 33260G, 33260C, 33260PR, 33260R, 36105R, 36115Y, 36100Y, 36110R, 36203R, 36203Y, 36140C, 36145C

DISPLAY INSERT



LED DISPLAYS, STOP/TURN/TAIL

FEATURES

- All units have individually contained power supplies
- Sleek, clean, professional look to assist in product sales
- Interchangeable lighted panels



Part Number	WxH	Included Lights
97379	24.25" H x 17" W	4058, 4050, 44302R

LIGHTED MERCH DISPLAY



LED DISPLAYS, STOP/TURN/TAIL, INSERT



Part Number	WxH	Included Lights
97485	16.73" H x 12.23" W	SS4058, SS4050, 44302R

DISPLAY INSERT

DISPLAY BASE

**LED DISPLAYS,
DISPLAY BASE**



FEATURES

- Display base hangs on a wall or gondola and can stand on a counter, shelf, or window exhibit

WORKS WITH THESE LIGHTING INSERTS:

- 97487 • 97484
- 97488 • 97486
- 97489 • 97485

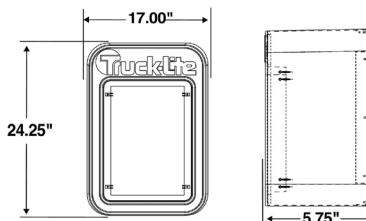

Part Number	WxH
97408	24.25" H x 17" W

DISPLAY BASE

**LED DISPLAYS,
DISPLAY BASE ,
SIGNAL-STAT LED VALUE LINE**



FEATURES

- Display base hangs on a wall or gondola and can stand on a counter, shelf, or window exhibit

WORKS WITH THESE LIGHTING INSERTS:

- 97482

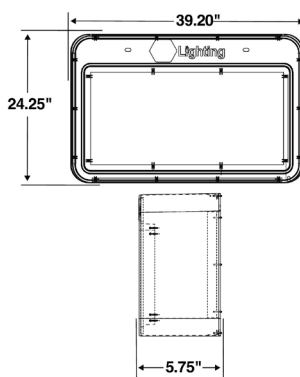

Part Number	WxH
97406	24.25" H x 39.2" W

DISPLAY BASE

**LED DISPLAYS,
DISPLAY BASE , LED PREMIUM LINE**



FEATURES

- Display base hangs on a wall or gondola and can stand on a counter, shelf, or window exhibit

WORKS WITH THESE LIGHTING INSERTS:

- 97483

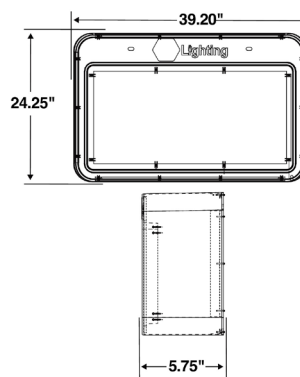

Part Number	WxH
97480	24.25" H x 39.2" W

SHOP FLOOR CABINET, KITS



led



signal-stat

FEATURES

- 24-compartment cabinet
- Organizes cluttered shelf inventory
- Part selection covers 75% of common repair work
- Easy to manage and fulfill replacement orders
- Great assortment of lamps for standard repair and inspection stations
- To customize the cabinet, please contact your local Truck-Lite regional manager

LED SHOP FLOOR CABINET, KIT

Part Number	H x W x D	Description	Replacement Parts
55664	42" H x 33.88" W x 11.88" D	Cabinet with inventory	47, 10250R/Y, 10700, 15250R/Y, 15205, 19350R/Y, 33050R/Y, 30250R/Y, 30700, 44350C, 44302R, 40700, 60250R, 66205C, 60240Y, 60700, 81360, 94706, 94902, 55650
55650	42" H x 33.88" W x 11.88" D	Cabinet only	

KIT INCLUDES:

- | | | | | |
|-------------------|-------------------|-----------------|-----------------|-----------------|
| • 47 (10 ea) | • 15205 (6 ea) | • 30700 (6 ea) | • 60250R (6 ea) | • 81360 (4 ea) |
| • 10250R/Y (6 ea) | • 19350R/Y (6 ea) | • 44350C (6 ea) | • 66205C (4 ea) | • 94706 (16 ea) |
| • 10700 (6 ea) | • 33050R/Y (6 ea) | • 44302R (6 ea) | • 60240Y (6 ea) | • 94718 (16 ea) |
| • 15250R/Y (6 ea) | • 30250R/Y (6 ea) | • 40700 (6 ea) | • 60700 (6 ea) | • 55650 (1 ea) |

SIGNAL-STAT SHOP FLOOR CABINET, KIT

Part Number	H x W x D	Description	Replacement Parts
55665	42" H x 33.88" W x 11.88" D	Cabinet with inventory	47, 1050/A, 10700, 1560/A, 2750, 1960/A, 4051/A, 3050/A, 30700, 6050/A, 6060C, 60700, 8180, 94993, 94902, 55650
55650	42" H x 33.88" W x 11.88" D	Cabinet only	

KIT INCLUDES:

- | | | | |
|------------------|------------------|------------------|-----------------|
| • 47 (10 ea) | • 2750 (6 ea) | • 30700 (10 ea) | • 8180 (5 ea) |
| • 1050/A (10 ea) | • 1960/A (10 ea) | • 6050/A (10 ea) | • 94993 (10 ea) |
| • 10700 (10 ea) | • 4051/A (10 ea) | • 6060C (6 ea) | • 94902 (10 ea) |
| • 1560/A (10 ea) | • 3050/A (10 ea) | • 60700 (10 ea) | • 55650 (1 ea) |

TECHNICAL INFORMATION & REFERENCE

Category	Page
Vapor Proof	480
Understading IP Ratings	481
Benetifs of LED Lighting Technology	482-483
FAQS	484-485
Federal Lighting Regulations	486-494
Warranty & Procedures	495-500
Product Interchange	501-512
Numerical Index	513-535



Truck-Lite[®] Sealed Systems
- A R E -

CERTIFIED VAPOR-PROOF

COMPLIANT



Underwriters Laboratories | UL 1604



National Fire Protection Agency | NFPA 493

Understanding IP Ratings



Ingress Protection Marking



SOLID Protection WATER Protection

So these mean what?

Solid Foreign Object Protection	
0	No protection
1	Protected against solid objects over 50 mm
2	Protected against solid objects over 12 mm
3	Protected against solid objects over 2.5 mm
4	Protected against solid objects over 1 mm
5	Protected against dust
6	Totally protected against dust

Water Ingress Protection	
0	No protection
1	Protected against vertically falling drops of water
2	Protected against direct sprays of water up to 15° from vertical
3	Protected against sprays of water up to 60° from vertical
4	Protected against water splashed from any direction
5	Protected against low pressure jets of water from any direction
6	Protected against strong jets of water from any direction
7	Protected against immersion up to 1 meter for 30 minutes
8	Protected against complete continuous submersion in water

The Benefits of LED Lighting Technology

LED lighting technology is perhaps the most important development the trucking industry has seen in terms of efficiency and safety in the last 30 years. Since the release of our first LED lighting system in 1993, Truck-Lite has led the industry in tough, reliable, long-lasting LED products

SIGNAL LIGHTING

Truck-Lite introduced the world's first LED Stop/Turn/Tail lamp in response to the industry's need for longer-lasting, more durable lighting. Since then, the adoption rate of this zero-maintenance technology has increased to the point of being standard for virtually all OEMs and fleet specifications.

The primary benefit of Truck-Lite LED lighting is that the solid-state nature provides a lifetime lighting solution. Others include brighter and faster illumination, resulting in an increased reaction time of three feet for every 10 miles per hour; lower current draw, resulting in increased battery and alternator life and more power for other vehicle requirements; increased resistance to shock and vibration due to lack of filament associated with incandescent lighting; and exponentially longer lifespan than traditional lighting options. Paired with our lifetime harness systems, Truck-Lite LED lighting offers worry-free lighting throughout the life of your vehicle.

**TRUCK-LITE LED SIGNAL LIGHTING
IS RATED FOR 100,000 HOURS**

FORWARD LIGHTING

We developed the industry's first LED forward lighting system in 2007 and have been perfecting the technology ever since.

continue on next page



LED headlights exert less energy on a vehicle’s electrical system than traditional halogen bulbs, and provide purer, whiter light. Truck-Lite’s LED headlights produce a color temperature that is identical to sunlight, providing enhanced object recognition and drastically better spread and distance down the road. Furthermore, the wavelength produced by Truck-Lite’s LED lighting falls within the melatonin suppression zone, due to higher intensity wavelengths that cover more of the color spectrum than halogen bulbs. This frequency has been proven to reduce drowsiness (similar to the way watching TV or other backlit screens before bed can negatively affect one’s REM cycle). Finally, Truck-Lite’s enhanced beam patterns, created with state-of-the-art optical design software, highlights more of the road without causing glare or disturbance to oncoming traffic.

CARE AND MAINTENANCE

Designed to last the life of the vehicle, LED lighting systems from Truck-Lite can help drivers and fleets to maximize uptime and save on maintenance costs with their rugged build and solid-state components that stand up to the rigors of the road. And, by offering more lumens per watt with a lower power draw, Truck-Lite LEDs offer increased visibility and safety while freeing up energy for other electronic devices that are necessary for a fleet’s success.

LED HEADLIGHTS LAST 30 TIMES LONGER THAN HALOGEN HEADLIGHTS.

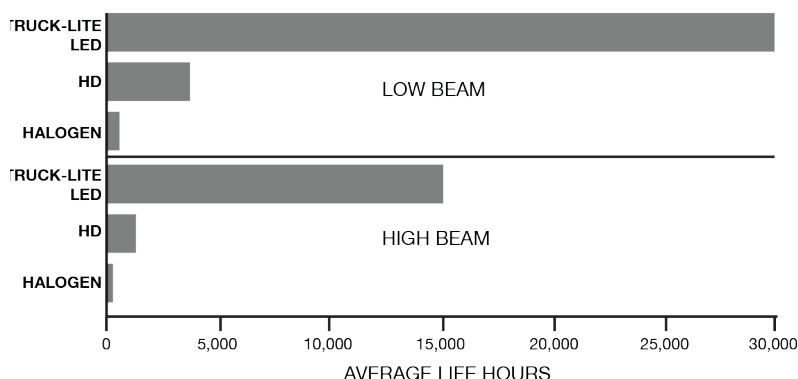

Though LED lighting can come at a higher price, we find that fleets that have a good system of measuring operational costs find it an easy decision to switch to LED lighting systems.

Frequently Asked Questions

What lights do I need?

Check the specific vehicle requirements or contact Truck-Lite Technical Support. Note that states cannot require anything different than what is in FMVSS-108; however, states can add regulations. Contact Truck-Lite for special situations.

The vehicle has everything needed for FMVSS-108, so why did the State Police give me a ticket?

States can regulate anything not covered by FMVSS-108, such as any accessory lamps or lamps that are not mandated by FMVSS-108. Generally, the problem is in these areas. Sometimes, however, it can simply be a mistake. In that case, Truck-Lite can often write a letter to clarify the issue.

What are combination marker/clearance lights, and how do I mount them?

A combination marker/clearance light is one light doing the work of two. It must be at a 45-degree angle (on corners) to be legal. It needs to be marked "PC" in the lens code. For further information, contact Truck-Lite.

How hard should I tighten down (torque) plastic lights or devices?

Over-torquing will generally cause cracking or distortion. Use the torque specifications provided by the manufacturer. A marker light will generally be about 8 to 20 inch-lbs., but a good rule of thumb is to use the minimum torque necessary to secure the device.

Are heavy-duty harnesses worth the extra cost?

We think so! Heavy-duty harnesses provide an independent (secure) ground and less voltage drop and are completely sealed to avoid corrosion. We don't recommend taking any chances when it comes to safety and efficiency.

What is the 12 Square Inch Rule?

On December 1, 1991, the National Highway Traffic Safety Administration (NHTSA) made effective the final ruling regarding the 12 Square Inch Rule. This ruling requires that the total luminous lens area for a stop and turn light must not be less than 75 centimeters squared (11.625 square inches) when used on vehicles over 80 inches wide. It must be noted that a reflex reflector ring cannot be counted as square inch lens area. When the reflex ring is subtracted from the total 12-inch lens, it leaves less than the 12 square inches required.

Is it illegal or non-compliant to use LED lamps that have clear lenses, but produce red or yellow output?

No. There is nothing illegal or non-compliant about having red or yellow LEDs behind clear lenses. When illuminated, the effective colors of the lights are red or yellow, which are approved colors of SAE J578c requirements. Clear lenses are legally approved for SAE J578c regulations as well. For a specific statement of the requirements, please review the NHTSA regulations charts.

Frequently Asked Questions

Is it okay to mount a lamp at an angle that isn't "square" on the vehicle?

The legality of a lamp's positioning varies on a case-by-case basis, often requiring a special lab test for each position. However, Truck-Lite products specifically state the proper mounting position(s), so you can be sure that your lamp and its positioning are fully compliant with all regulations.

Can I ever use the Model 40 with reflex reflector ring legally?

Yes, the Model 40 with reflex reflector ring can be used in the following situations:

- On any vehicle under 80" wide
 - As an "extra" light on over 80" (reflex is legal)
 - On vehicles made in 1991 or earlier, when installed by the vehicle's owner (although most states enforce the federal requirement)
-

Is SAE or DOT lettering required on lights?

Lettering is not required by NHTSA (FMVSS-108) except for headlights and conspicuity tape. The Federal Motor Carrier Safety manual mentions that some lights should be marked SAE but this is not enforced. Truck-Lite marks all their lights with SAE and/or DOT markings, where applicable.

Are there any special lighting requirements for vehicles hauling flammable or explosive materials?

There are no special federal requirements, as FMVSS-108 covers all over-the-road vehicles. Some states or municipalities have regulations, but these cannot supersede FMVSS-108 – they can only add to it. Truck-Lite's lights and wiring systems have been tested to all known standards and certifications. Reports are available from Truck-Lite, if necessary.

FMVSS-108 says that some lights must be mounted "as high as practicable." What is practicable?

NHTSA has stated that the vehicle manufacturer has the responsibility to choose the best mounting location "in light of the particular design/configuration of the vehicle involved" and they will not contest it unless it is "clearly erroneous." Recently, Canada has started to strictly enforce the word practicable as meaning "capable of being done." In the case of side markers, this means not more than six inches from the edge of the vehicle.

My customer wants to use a light for a side turn that isn't listed for that function. Is this OK, seeing as how side turns aren't required anyway?

Be careful that it doesn't violate some state laws regarding color or location. If it is also used as a side marker, the function must be listed on the lens code.

My customer wants to add some auxiliary lights (i.e. illuminated signs, deceleration lights, decorative lights). Are these legal?

Yes, provided they do not render inoperative any device in compliance with FMVSS-108, negatively affect the performance of required equipment or create confusion or misunderstanding of lighting signals. Feel free to contact Truck-Lite if you have any questions!

Trailer Equipment Location Requirements

To read, please use the chart on the following pages.

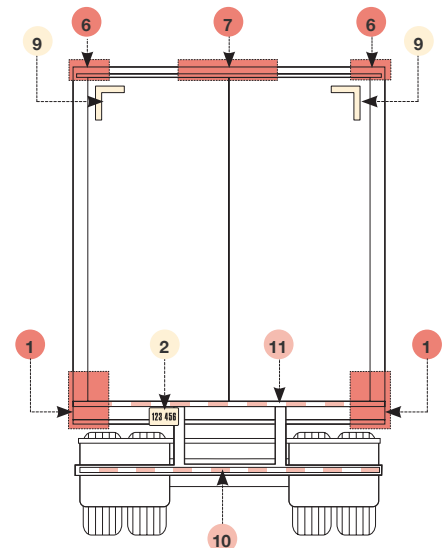
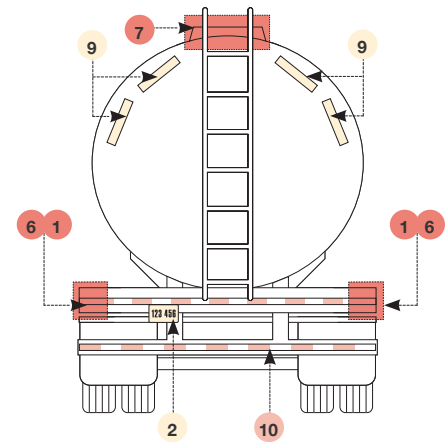
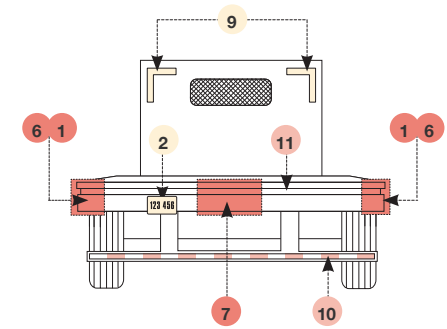
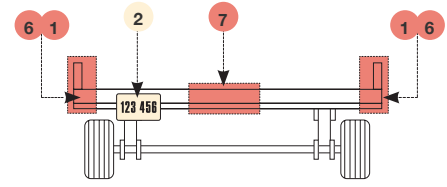
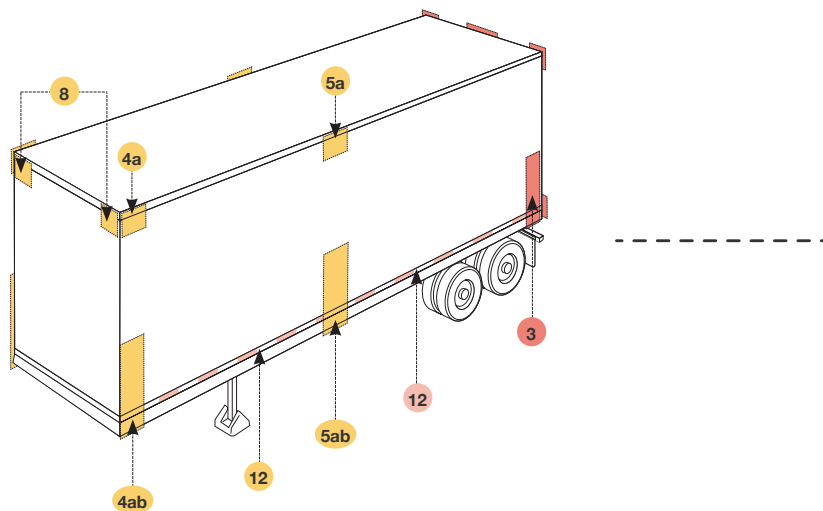
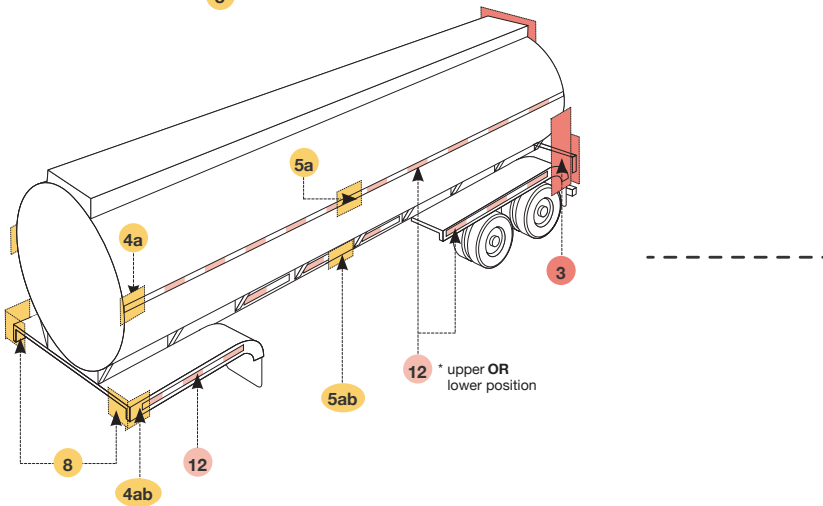
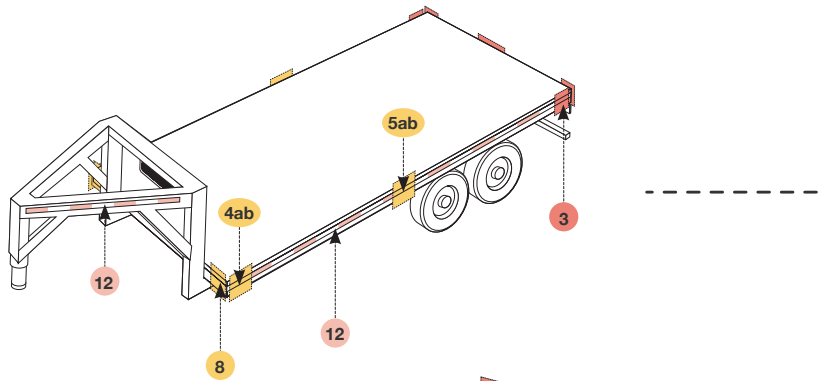
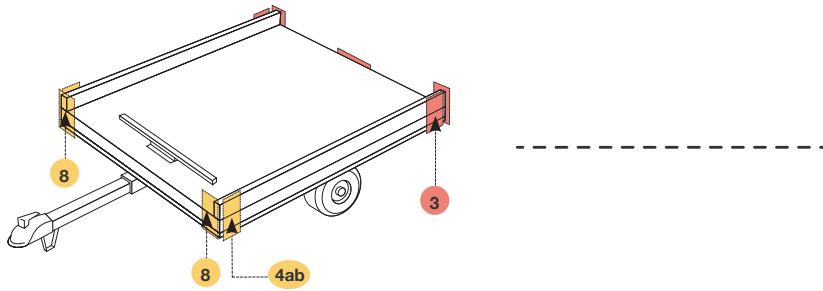

To read, please use the chart on the following pages.

Trailer Equipment Location Requirements

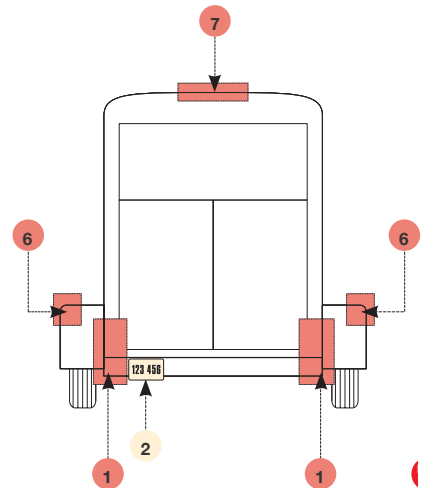
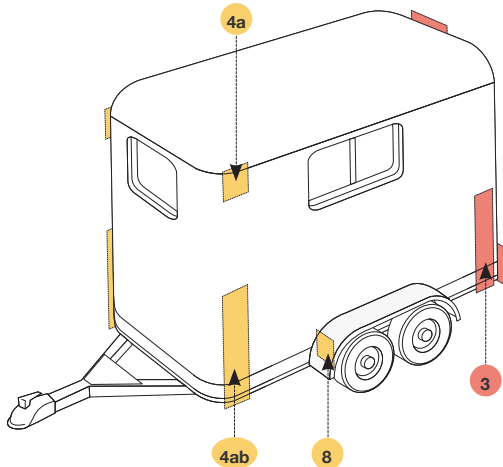
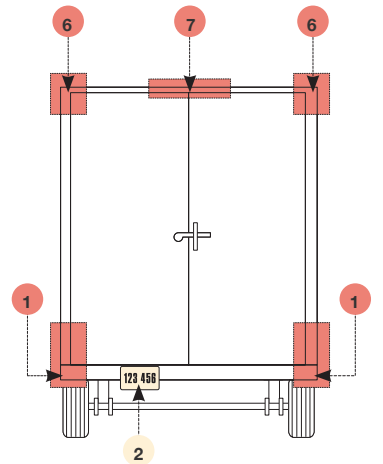
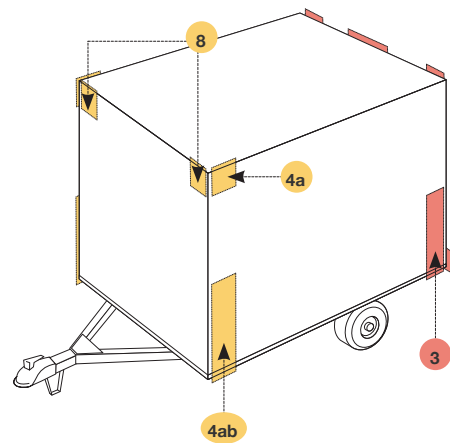
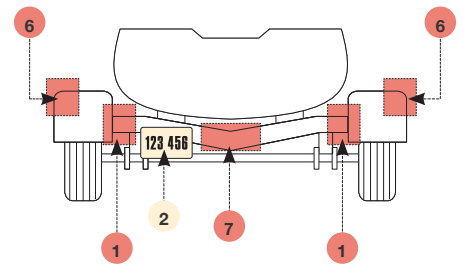
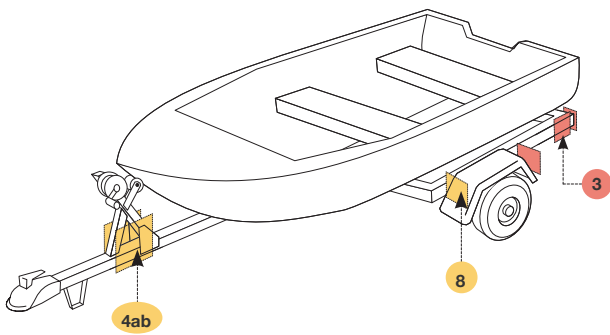
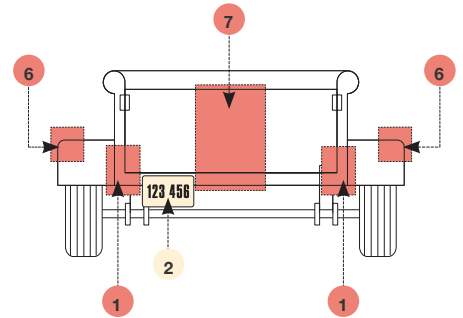
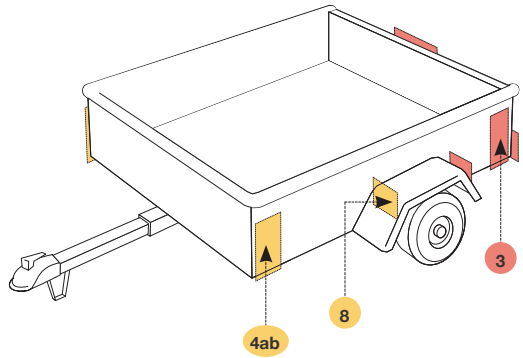

BASIC EQUIPMENT REQUIRED ON ALL TRAILERS

Trailer Equipment Locations | All Trailers Over 80 Inches



* Photometrically certified at installation angle

Description & Mandatory Requirements

	Equipment	SAE Lens Coding	Function	Quantity	Location	Height & Height From Ground
1	Tail Lamps	(T)	Indicate vehicle's presence & width	Min. 2	On rear - symmetrical as far apart as practicable	380-1830mm (15-72 in.)
	Stop Lamps	(S)	Indicate breaking	Min. 2	On rear - symmetrical as far apart as practicable	380-1830mm (15-72 in.)
	Rear Turn Sig. Lamp	(I)	Indicate direction of turn	Min. 2	On rear - symmetrical as far apart as practicable	380-2110mm (15-83 in.)
	Rear Reflex Reflectors	(A)	Indicate vehicle's presence & width	Min. 2	On rear - symmetrical as far apart as practicable facing rearward	380-1530mm (15-60 in.)
2	License Plate Lamps	(L)	Illuminates license plate	Min. 1	On the rear - above or at the sides of license plate	No requirements
3	*Rear Side Marker Lamps	(P2, PC* or P3, PC2*)	Front & rear side marker lamps/side reflex reflectors indicate vehicle's presence & length	Min. 2	Each side at rear as far back as practicable	380-1530mm (15-60 in.) no max. for veh. under 2032 mm (80 in.) wide
	Rear Side Reflex Reflectors	(A)	Front & rear side marker lamps/side reflex reflectors indicate vehicle's presence & length	Min. 2	Each side at rear as far back as practicable facing sideways	380-1530mm (15-60 in.)
4	a *Front Side Marker Lamps	(P2, PC* or P3, PC2*)	Front & rear side marker lamps/side reflex reflectors indicate vehicle's presence & length	Min. 2	Each side at front as far forward as practicable	380 mm (15 in.) minimum
	b Front Side Reflex Reflectors	(A)	Front & rear side marker lamps/side reflex reflectors indicate vehicle's presence & length	Min. 2	Each side front as far forward as practicable facing sideways	380-1530mm (15-60 in.)

Description & Mandatory Requirements

Length 9.1 m (30 ft.) or longer & Width 2032 mm (80 in.) or wider

	Equipment	SAE Lens Coding	Function	Quantity	Location	Height & Height From Ground
5	a Intermediate Side Marker Lamps	(P2 or P3)	Indicates presence of a long vehicle	Min. 2	Each side near center facing sideways	380mm (15 in.) minimum
	b Intermediate Side Reflex Reflectors	(A)		Min. 2	Each side near center facing sideways	380-1530mm (15-60 in.)
6	*Rear Clearance Lamps	(P2, PC* or P3, PC2*)	Show vehicle's width MAY NOT be combined with tail lamps	Min. 2	At widest point-symmetrical on the rear of near the rear facing rearward	As high as practicable may be lower only if ID lamps are at top
	7 Rear Identification Lamps	(P2 or P3)	Indicates presence of a wide vehicle	Exactly 3	On the rear-center horizontally spaced-150 mm (6 in.) to 300 mm (12 in.) apart facing rearward	At the top-may be lower if door header narrower than 25 mm
8	*Front Clearance Lamps	(P2, PC* or P3, PC2*)	Show vehicle's width	Min. 2	At widest point-symmetrical on the front or near the front facing forward	As high as practicable

Description & Mandatory Requirements

Width 2032 mm (80 in.) or wider & GVWR 4536 kg (10,001 lb.) or more

	Conspicuity Treatment	DOC Coding	Quantity	Location	Height	Options
9	Rear Upper Body Markings	DOT-C DOT-C2 DOT-C3 DOT-C4	Exactly 2 pairs of 300 mm long strips	On the rear upper corners facing rearward	At the top	Reflex reflectors (#3) may not be required if they are replaced in their required location with conspicuity treatment. Optional in Canada: Rear lower body and side conspicuity also be solid white, solid yellow, or white & yellow.
10	Bumper Bar Markings	DOT-C DOT-C2 DOT-C3 DOT-C4	Continuous	On the rear bumper bar's horizontal element full width of the vehicle facing rearward	No requirement	
11	Rear Lower Body Marking	DOT-C DOT-C2 DOT-C3 DOT-C4	Continuous	On the rear full width of the vehicle facing rearward	As horizontal & as close as practicable to the range of 375mm to 1525 mm from the ground	
12	Side Marking	DOT-C DOT-C2 DOT-C3 DOT-C4	(see location)	Each side-facing sideward continuous, or evenly spaced over minimum of 50% length starts & ends as close to the front & rear of the vehicle as practicable	As horizontal & as close as practicable to the range of 375 mm to 1525 mm from the ground	

Truck, Bus, MPV Equipment Location Requirements

To read, please use the chart on the following pages.

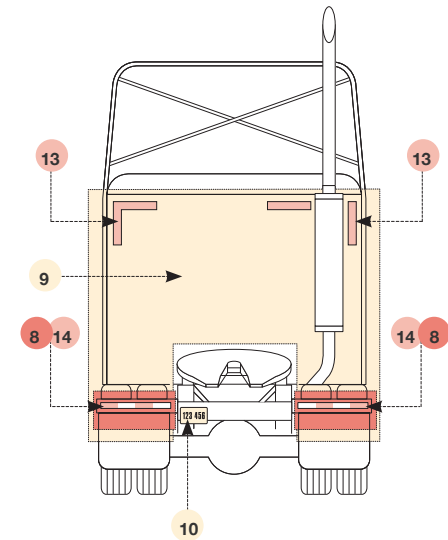
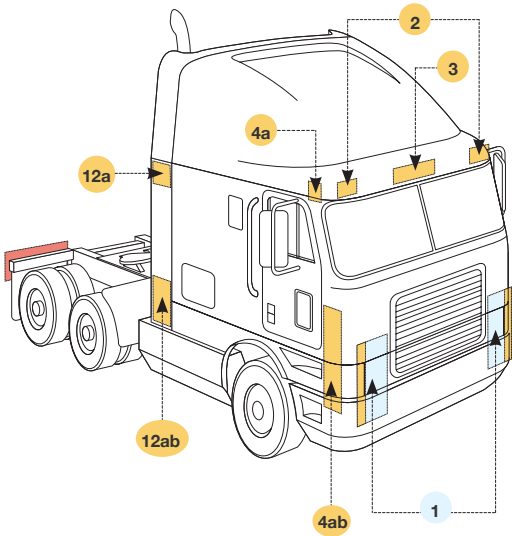
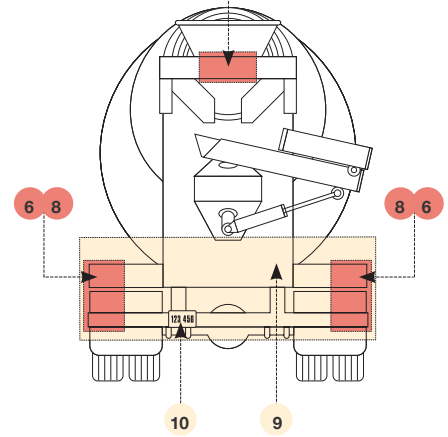
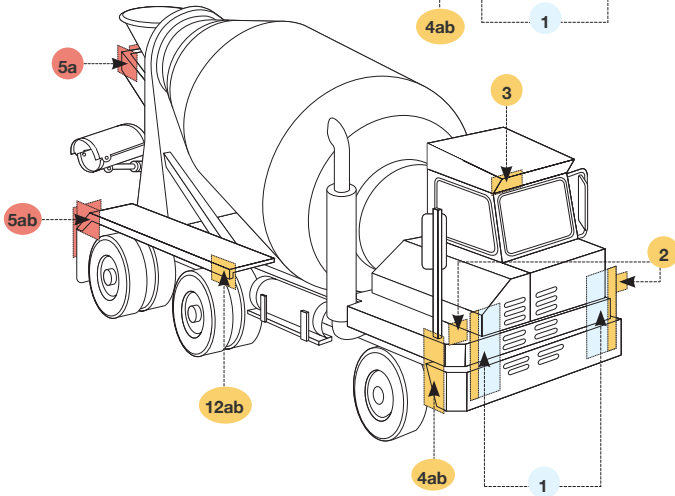
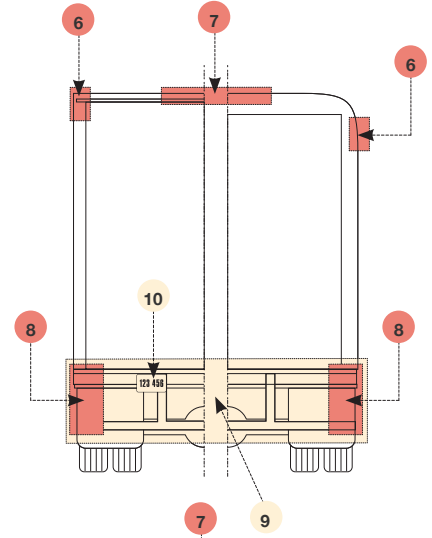
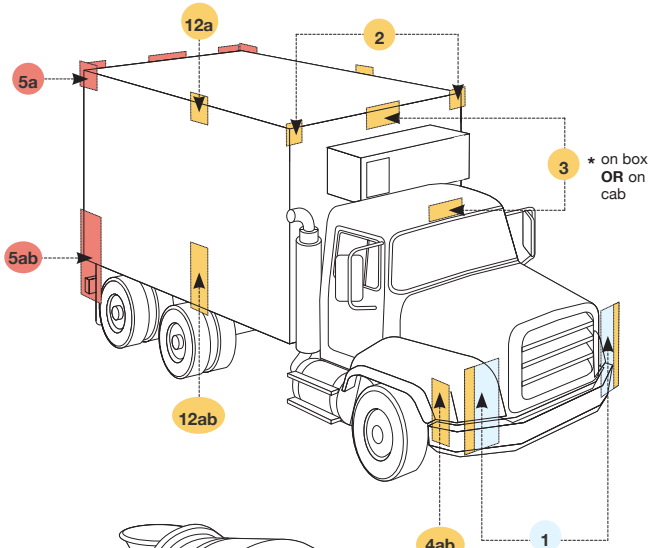

To read, please use the chart on the following pages.

Truck, Bus, MPV Equipment Location Requirements

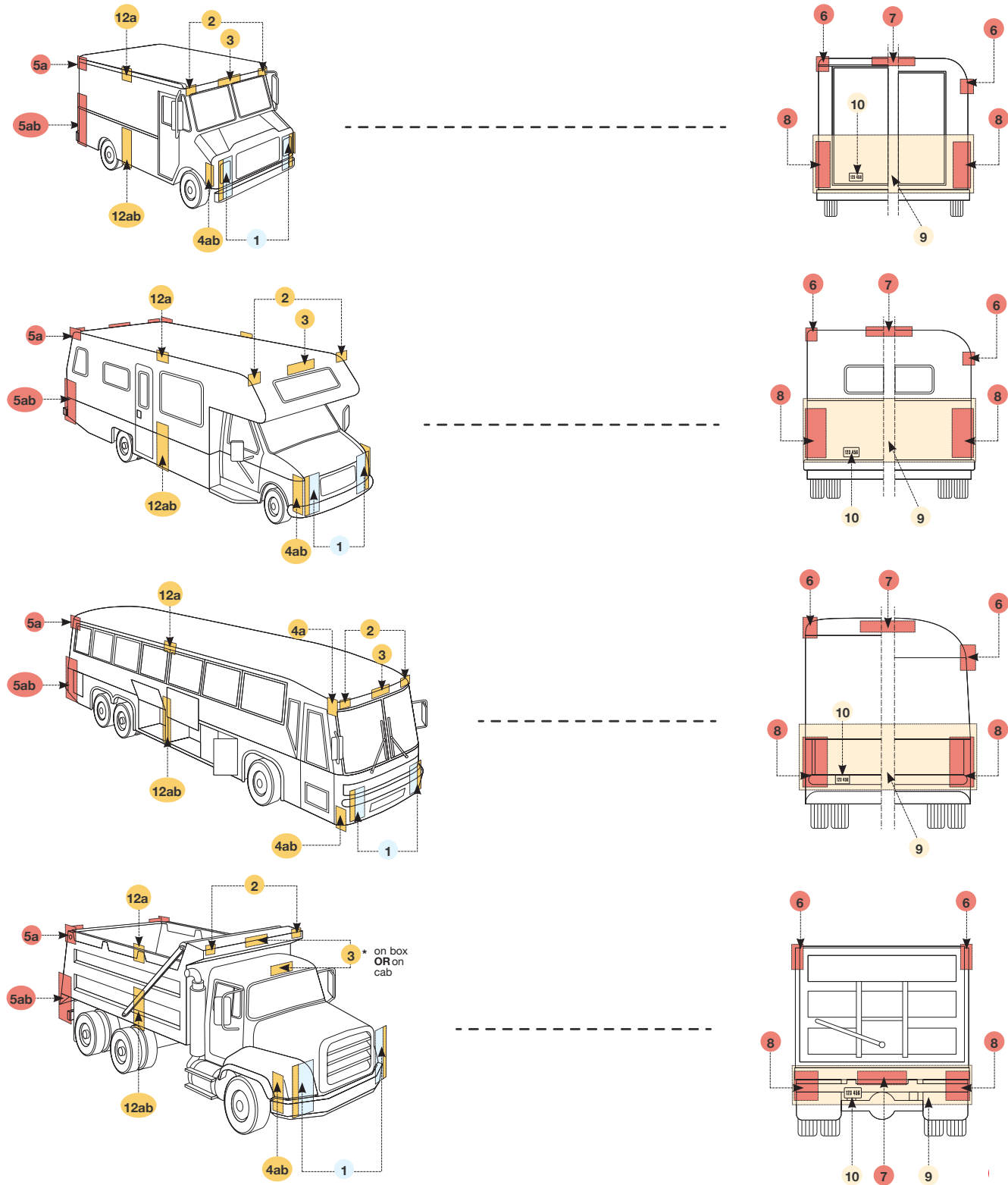

TRUCK, BUS, MPV EQUIPMENT LOCATION REQUIREMENTS

Trailer Equipment Locations | All Trailers Over 80 Inches



* Photometrically certified at installation angle

Description & Mandatory Requirements

	Equipment	SAE Lens Coding	Function	Quantity	Location	Height From Ground
1	Headlamp-Lower Beam	(H, HR)	Forward road illumination, US requires 'DOT' lettering on lens US&Canada -light code required on lens	Min. 2	Front-symmetrical as far apart as practicable if 4 lamp system-outboard or above upper beams	560-1370mm (22-54 in.)
	Headlamps-Upper Beam	(H, HR)	Forward road illumination, US requires 'DOT' lettering on lens US&Canada -light code required on lens	Min. 2	Front-symmetrical if 4 system-inboard or below lower beams	560-1370mm (22-54 in.)
	Parking Lamps	(P)	Indicate parked vehicle vehicles less than 2032 mm wide	Min. 2	Front-symmetrical as far apart as practicable	380-1830mm (15-72 in.)
	Daytime Running Lamps	(Y2)	Indicate in use vehicle Canada- required/US option US requires lettering on lens if not headlamps	Min. 2	Front-symmetrical as far apart as practicable	380mm (15 in.) min. Max. depends on DRL type
2	Front Turn Sig./Hazard Warning lamps	(I)	Indicate direction of turn/identify disabled vehicle	Min. 2	Front-symmetrical as far apart as practicable	380-2110mm (15-83 in.)
	Front Clearance Lamps	(P2, PC or P3, PC2*)	Show vehicle's width Vehicles 2032mm wide or wider	Min. 2	At widest point-symmetrical on the front or near the front facing forward	As high as practicable
3	Front Identification Lamps	(P2, or P3)	Indicate presence of a wide vehicle Vehicles 2032mm wide or wider	Exactly 3	On the front-center horizontally space 150 mm (6 in.) to 300 mm (12 in.) apart	As high as practicable or the top of the cab
4	a *Front Side Marker Lamps	(P2, PC* or P3, PC2*)	Front & rear side marker lamps/side reflex reflectors indicate vehicle's presence & length	Min. 2	Each side at front as far forward as practicable	380mm (15 in.) minimum
	b Front Side Reflex Reflectors	(A)	Front & rear side marker lamps/side reflex reflectors indicate vehicle's presence & length	Min. 2	Each side front as far forward as practicable facing sideways	380-1530mm (15-60 in.)

Description & Mandatory Requirements

	Equipment	SAE Lens Coding	Function	Quantity	Location	Height From Ground
5	a *Rear Side Marker Lamps	(P2, PC* or P3, PC2*)	Front & rear side marker lamps/side reflex reflectors indicate vehicle's presence & length	Min. 2	Each side at rear as far back as practicable	380mm (15 in.) minimum
	b Rear Side Reflex Reflectors	(A)	Front & rear side marker lamps/side reflex reflectors indicate vehicle's presence & length Not required on Truck Tractors	Min. 2	Each side at rear as far back as practicable facing sideward	380-1530mm (15-60 in.)
6	*Rear Clearance Lamps	(P2, PC* or P3, PC2*)	Show vehicle's width MAY NOT be combined with tail lamps Vehicles 2032mm wide or wider Not required on Truck Tractors	Min. 2	At widest point-symmetrical on the rear of rear the rear facing rearward	As high as practicable may be lower only if ID lamps are at top
7	Rear Identification Lamps	(P2 or P3)	Indicates presence of a wide vehicle Vehicles 2032mm wide or wider Not required on Truck Tractors	Exactly 3	On the rear-center horizontally spaced-150 mm (6 in.) to 300 mm (12 in.) apart facing rearward	At the top-may be lower if door header narrower than 25 mm
8	Trail Lamps	(T)	Indicates vehicle's presence and width	Min. 2	Rear-symmetrical as far as practicable	380-1830mm (15-72 in.)
	Stop Lamps	(S)	Indicate braking	Min. 2	Rear-symmetrical as far as practicable	380-1830mm (15-72 in.)
	Rear Turn Sig./Hazard Warning Lamps	(I)	Indicates direction of turn/identify disabled vehicle	Min. 2	Rear-symmetrical as far as practicable	380-1830mm (15-72 in.)
	Rear Reflex Reflectors	(A)	Show vehicle's presence & width	Min. 2	Rear-symmetrical as far as practicable	380-1830mm (15-72 in.)

CONTINUED ON NEXT PAGE

TRUCK, BUS, MPV EQUIPMENT LOCATION REQUIREMENTS

Trailer Equipment Locations | All Trailers Over 80 Inches



* Photometrically certified at installation angle

Description & Mandatory Requirements

Length 9.1 m (30 ft.) or longer & Truck Tractor

	Equipment	SAE Lens Coding	Function	Quantity	Location	Height From Ground
9	Backup Lamp	(R)	Illuminates ground behind the vehicle and alert road users	Min. 1	Rear	No requirement
10	License Plate Lamp(s)	(L)	Illuminates license plate	Min. 1	Rear-above or at the sides of license plate	No requirement
12	a Intermediate Side Marker Lamps	(P2 or P3)	Indicate presence of a long vehicle	Min. 2	Each side near center	380mm (15 in.) minimum
	b Intermediate Side Reflex Reflectors	(A)	Indicate presence of a long vehicle	Min. 2	Each side near center facing sideward	380-1530mm (15-60 in.)
	Conspicuity Treatment	DOC Coding	Quantity	Location	Height	Options
13	Rear Upper Body Markings	DOT-C DOT-C2 DOT-C3 DOT-C4	Exactly 2 pairs of 300 mm long strips	Rear upper corners of cab facing rearward	As high as practicable excluding fairings	—
14	Rear Marking	DOT-C DOT-C2 DOT-C3 DOT-C4	Exactly 2 sections of min. 600 mm each	Rear-facing rearward-on fenders, on mud flap brackets, or within 300 mm below the top of mud flaps	As horizontal as practicable and higher than 1525 mm from the ground	If mud flaps not used- on the cab or frame mounted brackets

SAE Device Codes • Letters Indicating Device Functions

A	Reflex reflector
A2	Reflex reflector for use on vehicles 2032mm or more in overall width
A3	Reflex reflector for conspicuity treatment (CT), for use on vehicles 2032mm or more in overall width
A4	Reflex reflector for CT (vehicles > 2032mm in width) - 50mm wide [truck/trailer]
A5	Reflex reflector for CT (vehicles > 2032mm in width) - 75mm wide [truck/trailer]
A6	Reflex reflector for CT (vehicles > 2032mm in width) - 100mm wide [truck/trailer]
A7	Reflex reflector for CT (vehicles > 2032mm in width) - 25mm wide [truck/trailer]
C	Motorcycle auxiliary front lamp
D	Motorcycle and motor-driven cycle turn signal lamp
DL	Distributed lighting system (headlamp)
E	Side turn signal lamp - vehicles 12m or more in length
E2	Side turn signal lamp - vehicles less than 12m in length
EVS1	Siren - interior location
EVS2	Siren - exterior location
EVS3	Siren - under hood location
F	Front fog lamp
F2	Fog tail lamps
G	Truck cargo lamp
H	Sealed beam headlamp
HC	Headlamp center
HG	Discharge forward lighting (headlamp)
HH	Sealed beam headlamp housing
HR	Replaceable bulb headlamp
I	Turn signal lamp spaced greater than 100mm from headlamp
I3	Turn signal lamp spaced from 75mm to less than 100mm from headlamp
I4	Turn signal lamp spaced from 60mm to less than 75mm from headlamp
I5	Turn signal lamp spaced less than 60mm from headlamp
I6	Rear mounted turn signal lamp and front mounted turn signal lamps mounted 100mm or more from the headlamp, for use on vehicles 2032mm or more in overall width
I7	Front mounted turn signal lamp mounted less than 100mm from the headlamp, for use on vehicles 2032mm or more in overall width
J1690	Flasher
K	Front cornering lamp
K2	Rear cornering lamp
L	License plate lamp
M	Motorcycle and motor-driven cycle headlamp - motorcycle type
N	Motorcycle and motor-driven cycle headlamp - moto driven cycle type
O	Spot lamp
P	Parking lamp
P2	Sidemarkers lamp for use on vehicles 2032mm or less in overall width
P3	Clearance, sidemarkers and identification lamp for use on vehicles 2032mm or more in overall width
PC2	Combination clearance and sidemarkers lamp for use on vehicles 2032mm in width or more in overall width
Q	Turn signal operating unit - Class A
QB	Turn Signal operating unit - Class B
QC	Vehicular hazard warning signal operating unit
QD1	Turn signal operating unit for use on vehicles 2032mm in width or more in overall width - Type 1
QD2	Turn signal operating unit for use on vehicles 2032mm in width or more in overall width - Type 2
QE1	Hazard warning operating unit for use on vehicles 2032mm in width or more in overall width - Type 1
QE2	Hazard warning operating unit for use on vehicles 2032mm in width or more in overall width - Type 2
R	Reversing (back-up) lamp
S	Stop lamp
S2	Stop lamp for use on vehicles 2032mm or more in overall width
T	Tail lamp (rear position lamp)
T2	Tail lamp (rear position lamp) for use on vehicles 2032mm or more in overall width
U	Supplemental high-mounted stop and turn signal lamp
U2	High-mounted stop lamp for use on vehicles 2032mm or more in overall width
U3	Center high-mounted stop lamp for passenger cars, light trucks and MPV's
W	Warning lamp for emergency, maintenance and service vehicles
W2	Warning lamp for school buses
W3-1	Optical warning device - Class 1
W3-2	Optical warning device - Class 2
W3-3	Optical warning device - Class 3
W4	Emergency warning device [triangular shape]
W5-1	360° gaseous discharge lamp - Class 1
W5-2	360° gaseous discharge lamp - Class 2
W5-3	360° gaseous discharge lamp - Class 3
X	Adaptive [forward] lighting system
Y	Auxiliary high beam lamp
Y2	Daytime running lamp
Z	Auxiliary low beam lamp

Cleaning Materials

The use of solvents which are not compatible with polycarbonate will result in the softening, crazing, and/or cracking of the plastic part. This is especially true of polycarbonate lamps & mounting bases which may be under stress in their normal applications.

The following solvents/cleaners are compatible with polycarbonate:

Mild soap and water	Dirtex®
Mineral Spirits	2% Sol. Reg. Joy
Hexane	Heptane
VM & P Naphtha	White Kerosene
Varsol No. 2	Methyl, isopropyl & isobutyl
#1 & #3 denatured	alcohols
alcohol	Lacryl® PCL-2035
Freone TF & TE-35	polycarbonate cleaner
Ethanol	Petroleum Ether/65 degrees C
10% Sol Bon Ami®	boiling point

The following solvents/cleaners **MUST NOT** be used with polycarbonate:

Trichlor	Carbon Tetrachloride	Diversol®
Acetone	Chlorinated Hydrocarbons	Lemon Joy®
Triclene®	Texize-8006, 8129, 8758	(phosphate free)
Methyl Ethyl Keytone	Liquid Cleaner - 8211	Kleenol Plastics
(MEK)	Agitene®	Lestoil®
MIBK	Ajax®	Lysol®
Toluol	All Liquid Detergents	Stanisol Naphtha®
Benzol	Pink Lux® (phosphate	Oils
Gasoline	free)	

Questions as to compatibility of other specific materials should be directed to the manufacturer and/or the Truck-Lite Corporate Laboratory.

Tips To Prolong Equipment Lighting

- Never use a test probe to pierce wire insulation when troubleshooting lighting complaints. Wicking action takes place which causes moisture to travel along the wire strands and corrode critical connections. If probing a harness or wire is necessary, make sure the puncture is properly sealed.
- To correct voltage problems, discover the real cause. Under-voltage often is caused by poor electrical connections. To correct under-voltage, don't just turn up the voltage — find out what caused the under-voltage problem.
- Many discarded lamps are still in good condition. Play detective when solving lamp problems. First, test with either a meter, power supply, or battery. Our 97100 tester is an excellent tool for this. Then if you desire, open the lens on a discarded lamp and examine the bulb. It will tell you why it failed. For example:
 - A bulb with stretched or broken filaments was subjected to vibration.
 - A yellowish, whitish or bluish glaze on the bulb indicates a rupture in the bulb glass envelope.
 - A dark metallic finish indicates old age.
 - A black, sooty bulb indicates a poor seal in bulb.
 Test all lamps one more time before you discard them. Truck-Lite's warranty department reports that up to 20 percent of all lamps sent back are still in good operating condition. The ones that aren't working can be turned over to your lamp supplier.
- All lamps will live longer if they run cool. Dirt on the lens increases the heat, so keep them as clean as possible. Other people can see your rig, and that is one of the purposes of the lighting system – to be seen. **Certain lighting products generate heat. Care should be taken to avoid contact with flammable materials.**
- Treat the electrical system as you would the chassis. Lubricate sockets, pigtails, battery terminals and connections with NYK 77 "non-conductive" anti-corrosion compound. The purpose of the sealant is to totally encapsulate and protect against corrosion and water.
- Inspect for improper ground connections. This is a major cause of lamp failure, especially when the trailer is used for a ground. When lamps are grounded through the lamp housing, make sure there is a clean connection (i.e., metal-to-metal). Also, a fifth wheel ground strap may be used for added protection on the chassis ground system.
- Look for loose, bare or unsupported wire, and fixtures. Harnesses and wiring should be on the underside of top frame members rather than on the bottom where dirt and road splash collect.
- Always replace wiring, trailer light cables, and harnesses with an equal or heavier gauge of wire than was used in the original specifications. If you don't, you may cause unnecessary problems.
- On older trucks, you should never crank the truck when any lights or accessories are on. Also, never leave markers and hazard lights on when parked against a dock. Melted lenses are a sure sign that the vehicle has been parked against the dock while the lights were on.
- Inspect the grommets that house the lamps. As they age, they eventually will deteriorate from sunlight, ozone and harmful chemicals. New grommets restore shock protection, security and improves appearance.

Warning Symbols



Lighting products generate heat! Care should be taken to avoid contact with flammable material.

Designed to conform to applicable Federal Safety Standards.
Meets applicable SAE Standards and US DOT Requirements.



Any unauthorized substitution or modification to products or packaging manufactured or sold by Truck-Lite could cause bodily injury or affect the performance and safe operation of the product. Truck-Lite Co., Inc. shall not be liable for personal injury or property damages caused by unauthorized substitutions or modifications.



Truck-Lite products do not place a person at risk by exposure to chemicals and can be properly disposed of in an approved landfill.



LEDs (Light Emitting Diodes) use less current than incandescent products and may affect the proper operation of other electronic devices or systems on the vehicle. Always confirm proper operations and/or verify the LED Lighting products compatibility with the vehicle manufacturer.

Limited Warranties & Procedures



Truck-Lite extends a Limited Warranty to the original purchaser that the warranted products defined below are free from defects in workmanship and/or materials only, whereby Truck-Lite will replace any warranted product to the original consumer/purchaser if the product fails because of defect due to workmanship and/or materials within the limited warranty period from the date imprinted on the product. Each Limited Warranty as applicable is not transferable and applies to the original installation of the Truck-Lite product. To be eligible for Limited Warranty protection the Truck-Lite products must remain intact, free from physical abuse, and not subject to improper installation. The Limited Warranty of the lamp products applies to 12-volt lamps only. This offer does not constitute in any way a product guarantee and Truck-Lite does not hereby assume any obligation of any kind whatsoever beyond sending a free replacement product. Unless expressly agreed to in writing by Truck-Lite, Truck-Lite does not warrant its products as to their fitness for any special use or function.

Truck-Lite believes our products should provide good service under proper operating conditions. In view of this, many of our products have a Limited Warranty for special periods of time, based on product date. These Limited Warranties are as follows:

- Super 40 series, 4" round sealed lamps (12 volt only) have a thirty-six (36) month limited warranty.
- Model 40 series, 4" round sealed lamps (12 volt only) have a twenty-four (24) month limited warranty.
- Super 10 series, 2-1/2" round sealed lamps (12 volt only) have a twenty-four (24) month limited warranty.
- Super 21 series, rectangular sealed lamps (12 volt only) have a twenty-four (24) month limited warranty.
- Super 45 series, rectangular stop/turn/tail sealed lamps (12 volt only) have a twenty-four (24) month limited warranty.
- Super 60 series, oval stop/turn/tail sealed lamps (12 volt only) have a twenty-four (24) month limited warranty.
- Signal-Stat LED series, see Signal-Stat LED Series Lamp Warranty.
- LED series lamps, see LED Limited Lifetime Lamp Warranty.
- Harness limited warranty, see Harness Warranty.
- LED series lamps and 88 series harness, see LED Limited Lifetime Lamp and Harness System Warranty.

Signal-Stat LED Series Lamp Warranty



Truck-Lite extends a Limited 2-Year Warranty to the original purchaser that the Signal-Stat Sealed LED lamp is free from defects in workmanship and/or materials only. Truck-Lite will replace any Sealed LED Lamp to the original consumer/purchaser, if the lamp fails due to defects in workmanship and/or materials only.

The LED Limited 2-Year Warranty does not apply to severe applications such as buses, construction equipment and off-road vehicles. These applications are example only and are not all inclusive of each excluded application. Many chemicals and/or cleaners are incompatible with Signal-Stat sealed LED products. The LED 2-Year Warranty does not apply to damage associated with incompatible chemicals or cleaners. Not subject to improper installation or modification and must be used only with Truck-Lite approved wiring accessories. Any violation of these conditions will void this LED 2-Year Lamp Warranty. This LED 2-Year Lamp Warranty is not transferable and applies to the original installation of the Signal-Stat Sealed LED lamp for as long as the original consumer/purchaser owns the vehicle.

LED Limited Lifetime Lamp Warranty



Truck-Lite extends a Limited Lifetime Warranty to the original purchaser that the Truck-Lite Sealed LED lamp is free from defects in workmanship and/or materials only. Truck-Lite will replace any Sealed LED Lamp to the original consumer/purchaser, if the lamp fails due to defects in workmanship and/or materials only. The LED LIMITED LIFETIME LAMP WARRANTY DOES NOT APPLY TO SEVERE APPLICATIONS such as buses, construction equipment and off-road vehicles. These applications are examples only and are not all inclusive of each excluded applications. MANY CHEMICALS AND/OR CLEANERS ARE INCOMPATIBLE with Truck-Lite Sealed LED products. The LED Limited Lifetime Lamp Warranty does not apply to damage associated with incompatible chemicals or cleaners.

LED Limited Lifetime Lamp Warranty



However, this LED Limited Lifetime Lamp Warranty will be extended to include exposure to chemicals and/or cleaners associated with use ONLY if Truck-Lite Sealed LED lamps are purchased with the optional "Diamond Shell™" hard coating. Truck-Lite Sealed LED lamps are to REMAIN INTACT, FREE FROM PHYSICAL ABUSE, NOT SUBJECT TO IMPROPER INSTALLATION OR MODIFICATION AND MUST BE USED ONLY WITH TRUCK-LITE APPROVED WIRING ACCESSORIES. ANY VIOLATION OF THESE CONDITIONS WILL VOID THIS LED LIMITED LIFETIME LAMP WARRANTY.

This LED Limited Lifetime Lamp Warranty is not transferable and applies to the ORIGINAL INSTALLATION of the Truck-Lite Sealed LED lamp for AS LONG AS THE ORIGINAL CONSUMER/ PURCHASER OWNS THE VEHICLE (LIFETIME).

Truck-Lite Sealed LED lamps are designed to give the purchaser a wide variety of plug/ connection options. Each plug/connection option offers different performance characteristics. Therefore, Sealed LED lamps have a Limited Lifetime Warranty with the following two exceptions:

- Sealed LED lamps using standard bullet terminal/receptacle type connections integral to the lamp housing will have a three (3) year Limited Warranty.
- Sealed LED lamps, which are hardwired and use standard bullet terminal/receptacle type connections have a limited lifetime warranty on the lamp. Connector failure, however, is covered by a three (3) year Limited Warranty.
- Sealed LED lamps noted with a specific year warranty.

Limited Harness Warranty



Truck-Lite extends a Limited Harness Warranty to the original consumer/ purchaser that the Truck-Lite Series 50 and Series 88 harness systems are free from defects in workmanship and/or materials only. Truck-Lite will replace any Series 50 or Series 88 harness to the original consumer/ purchaser, if the product fails because of defects due to workmanship and/or materials only within five (5) years from the date of purchase of the product. This Limited Harness Warranty is not transferable and applies to the original installation of the product.

To be eligible for this Limited Harness Warranty protection the Series 50 or Series 88 harness system must have been PROPERLY INSTALLED, PROPERLY MAINTAINED, AND THE INTEGRITY OF THE SYSTEM MUST REMAIN INTACT. Series 50 or Series 88 harness systems MUST BE USED ONLY WITH TRUCK-LITE APPROVED LIGHTING PRODUCTS AND ACCESSORIES. USE OF UNAPPROVED LIGHTING PRODUCTS AND ACCESSORIES WILL VOID THIS LIMITED HARNESS WARRANTY.

Limited Lifetime LED Lamp & Harness Systems Warranty



Truck-Lite extends a LIMITED LIFETIME LED LAMP AND HARNESS SYSTEMS WARRANTY that Lighting Systems featuring Truck-Lite Series 88 harness and Truck-Lite Sealed LED lamps equipped with Fit 'N Forget connections are free from defects in workmanship and/or materials only. Truck-Lite will replace defective Series 88 harness components and LED lamps with Fit 'N Forget connections to the original consumer/purchaser, if the product fails due to defects in workmanship or materials. This Limited Lifetime LED Lamp and Harness Systems Warranty applies to the original installation of the product only. This Limited Lifetime LED Lamp and Harness Systems Warranty extends for as long as the ORIGINAL CONSUMER/PURCHASER OWNS THE VEHICLE.

MANY CHEMICALS AND/OR CLEANERS ARE INCOMPATIBLE with Truck-Lite Sealed LED products. This Limited Lifetime LED Lamp and Harness Systems Warranty does not apply to damage associated with the use of incompatible chemicals or cleaners (Questions as to compatibility of specific materials should be directed to the manufacturer and/or the Truck-Lite Corporate Laboratory). However, this Limited Lifetime LED Lamp and Harness Systems Warranty will apply and include exposure to chemical/cleaners associated with use ONLY if Truck-Lite Sealed LED lamps are purchased with optional "Diamond Shell™" hard coating.

Truck-Lite Series 88 harness components and Truck-Lite Sealed LED lamps are to be PROPERLY INSTALLED, REMAIN INTACT, FREE FROM PHYSICAL ABUSE, AND NOT SUBJECT TO MODIFICATION. ANY VIOLATION OF THESE CONDITIONS WILL VOID THIS LIMITED LIFETIME LED LAMP AND HARNESS SYSTEMS WARRANTY.

The Truck-Lite Limited Lifetime LED Lamp and Harness Systems Warranty Program does not constitute, in any way, a product guarantee, and Truck-Lite does not assume any obligations of any kind whatsoever beyond sending a free replacement of the product covered by the Limited Lifetime LED Lamp and Harness Systems Warranty.

In no event shall Truck-Lite be liable for incidental or consequential damages, nor shall Truck-Lite's liability for any claims or damage arising out of or connected with this Limited Lifetime LED Lamp and Harness Systems Warranty or the manufacture, sales, delivery or use of the products with which this Limited Lifetime LED Lamp and Harness Systems Warranty is concerned exceed the purchase price of the products.

There are no warranties, expressed or implied (including any warranty of merchantability or fitness), which extend beyond this warranty. The loss of use of the product, loss of time, inconvenience, commercial loss, incidental or consequential damages are not covered. The manufacturer reserves the right to change the design of the product without assuming any obligation to modify any product previously manufactured or to replace warranted product other than with redesigned product.

Product Warranty

All other products in our catalog may be eligible for a replacement if the failure is deemed to be due to a failure in either material or workmanship within one year of purchase. The replacement of defective products is made at the discretion of Truck-Lite Co., Inc. and is based on the results of an analysis of the returned products by our warranty administrator.

Products submitted for Limited Warranty consideration may be inspected by our laboratory. Replacement will be based upon Truck-Lite uniform limited warranty procedure and/or the result of the laboratory evaluation. Charges for damages and/or labor costs cannot be accepted by Truck-Lite Co., Inc. As stated earlier, we believe our products should provide good service under proper operating conditions, and this attitude will be reflected in our consideration of items returned for examination.

The Truck-Lite Limited Warranty Program does not constitute, in any way, a product guarantee, and Truck-Lite does not hereby assume any obligations of any kind whatsoever beyond sending a free replacement of the product when covered by a Limited Warranty.

There are no warranties, expressed or implied (including any warranty of merchantability or fitness), which extend beyond this Limited Warranty. The loss of use of the product, loss of time, inconvenience, commercial loss, incidental or consequential damages are not covered. The manufacturer reserves the right to change the design of the product without assuming any obligation to modify any product previously manufactured or to replace warranted product other than with redesigned product.

This Limited Warranty gives you special legal rights. You may also have other rights from state to state. Some states do not allow limitations on how long an implied warranty lasts. Some states do not allow the exclusion or limitation of incidental or consequential damages. Therefore, the above limitation(s) or exclusion(s) may not apply to you.

Product Replacement Instructions

To be eligible for Limited Warranty consideration, contact the Truck-Lite Regional Salesman in your area or call Customer Service at 800/562-5012. Upon issuance of a RETURNED GOODS AUTHORIZATION NUMBER, return the failed product, freight prepaid to Truck-Lite Co., Inc., 2640 First Avenue, Falconer, New York 14733 to the attention of the warranty administrator.

Any product covered under the terms of the respective Limited Warranty will be replaced with another like product and will be sent directly to the original consumer/purchaser only. The consumer/ purchaser may request a written report on any product submitted for warranty evaluation that is not covered under the respective Limited Warranty. Items received will not be returned.

Additional crosses are available online within the advanced catalog search section.

AMERICAN SUPERLITE

AMERICAN SUPERLITE PART#	TRUCK-LITE PART #	MATCH LEVEL	AMERICAN SUPERLITE PART#	TRUCK-LITE PART #	MATCH LEVEL	AMERICAN SUPERLITE PART#	TRUCK-LITE PART #	MATCH LEVEL	AMERICAN SUPERLITE PART#	TRUCK-LITE PART #	MATCH LEVEL	AMERICAN SUPERLITE PART#	TRUCK-LITE PART #	MATCH LEVEL
20400	30700	M5	20200A	3050A	M5	40200RC	4051	M5	62100A	1050	M5	82200AC	6051A	M5
25400	10700	M5	20200AC	3051A	M5	40800W	4060C	M5	62100R	2150	M5	82200R	6050	M5
40400	40700	M5	20200RC	3051	M5	40800WU	44308C	M5	62100R	2660A	M5	82200RC	6051	M5
40500	40720	M5	40200A	4050A	M5	42100R	1050A	M5	62100R	3050	M5	82800W	6060C	M5
60400	60700	M5	40200AC	4051A	M5	42100R	2660	M5	80300G	60750	M5	82800WU	6060C	M5
60500	60720	M5	40200R	4050	M5	62100A	2150A	M5	82200A	6050A	M5			

BETTS

BETTS PART#	TRUCK-LITE PART #	MATCH LEVEL	BETTS PART#	TRUCK-LITE PART #	MATCH LEVEL	BETTS PART#	TRUCK-LITE PART #	MATCH LEVEL	BETTS PART#	TRUCK-LITE PART #	MATCH LEVEL	BETTS PART#	TRUCK-LITE PART #	MATCH LEVEL
800514	81360	M4	805501	81360	M4	805505	81360	M4	805530	81360	M4			
800516	81360	M4	805503	81360	M4	805507	81360	M4	805531	81360	M4			
800518	81360	M4	805504	81360	M4	805509	81360	M4						

BLAZER

BLAZER PART#	TRUCK-LITE PART #	MATCH LEVEL	BLAZER PART#	TRUCK-LITE PART #	MATCH LEVEL	BLAZER PART#	TRUCK-LITE PART #	MATCH LEVEL	BLAZER PART#	TRUCK-LITE PART #	MATCH LEVEL	BLAZER PART#	TRUCK-LITE PART #	MATCH LEVEL
BLAC6423	5050DK	M5	BLAC7421	5050DK	M5									

CHAM-CAL

CHAM-CAL PART#	TRUCK-LITE PART #	MATCH LEVEL	CHAM-CAL PART#	TRUCK-LITE PART #	MATCH LEVEL	CHAM-CAL PART#	TRUCK-LITE PART #	MATCH LEVEL	CHAM-CAL PART#	TRUCK-LITE PART #	MATCH LEVEL	CHAM-CAL PART#	TRUCK-LITE PART #	MATCH LEVEL
7202	97720	M5	13501	97618	M5	20731	97837	M5	40305	97667	M5	70101	97869	M5
7325	97721	M5	13503	97619	M5	20851	97643	M5	40401	97846	M5	70111	97748	M5
7326	97722	M5	13504	97620	M5	20852	97644	M5	40403	97668	M5	70201	97823	M5
10300	97990	M5	13601	97621	M5	20901	97645	M5	40404	97669	M5	70203	97849	M5
10303	7044	M5	13603	97622	M5	20903	97646	M5	40601	97848	M5	70311	97876	M5
10400	7048	M5	13604	97623	M5	20904	97647	M5	40603	97670	M5	70401	97718	M5
10481	97865	M5	20000	97624	M5	21101	97840	M5	40604	97671	M5	70503	97719	M5
10501	97872	M5	20080	97625	M5	24403	97811	M5	41301	97847	M5	70601	97845	M5
10503	97802	M5	20090	97626	M5	24404	97806	M5	41303	97672	M5	70701	97725	M5
10601	97819	M5	20100	97860	M5	24413	97650	M5	41304	97673	M5	70703	97726	M5
10603	97820	M5	20101	97812	M5	25503	97818	M5	41601	97674	M5	70841	97730	M5
10681	97602	M5	20200	97627	M5	25504	97808	M5	41603	97675	M5	70851	97731	M5
10683	97603	M5	20203	97628	M5	26200	97652	M5	41604	97676	M5	70911	97868	M5
10701	97815	M5	20204	97629	M5	30101	97653	M5	50101	97678	M5	70931	97732	M5
10703	97816	M5	20210	97630	M5	30103	97654	M5	50201	97850	M5	70961	97733	M5
10801	97803	M5	20230	97631	M5	30104	97807	M5	50203	97679	M5	80501	97734	M5
10803	97804	M5	20250	97632	M5	30201	97655	M5	50301	97852	M5	82701	97740	M5
10891	97606	M5	20301	97822	M5	30301	97656	M5	50304	97680	M5	90012	60737	M5
10893	97831	M5	20311	97809	M5	30303	97657	M5	50401	97681	M5	90013	60738	M5
10901	97863	M5	20321	97826	M5	30401	97800	M5	50801	97682	M5			
11103	97609	M5	20331	97827	M5	30403	97659	M5	60101	97829	M5			
11104	97610	M5	20351	97635	M5	30501	97805	M5	60111	97686	M5			
11105	97835	M5	20601	97861	M5	30504	97660	M5	60151	97687	M5			
11503	97611	M5	20603	97636	M5	30701	97661	M5	60171	97688	M5			
11504	97612	M5	20604	97637	M5	31701	97662	M5	60201	97828	M5			
12701	97817	M5	20611	97866	M5	40101	97862	M5	60601	97843	M5			
12801	97814	M5	20700	97839	M5	40201	97664	M5	60611	97693	M5			
12811	97614	M5	20701	97836	M5	40204	97665	M5	60613	97694	M5			
12813	97615	M4	20711	97837	M5	40303	97666	M5	60699	97695	M5			

Additional crosses are available online within the advanced catalog search section.

DIALITE

DIALITE PART#	TRUCK-LITE PART #	MATCH LEVEL	DIALITE PART#	TRUCK-LITE PART #	MATCH LEVEL	DIALITE PART#	TRUCK-LITE PART #	MATCH LEVEL	DIALITE PART#	TRUCK-LITE PART #	MATCH LEVEL	DIALITE PART#	TRUCK-LITE PART #	MATCH LEVEL
13071A	15250Y	M4	17101A	10051Y	M4	41151R	44030R	M4	62091R	60062R	M4	70151R	91252R	M4
13071R	15250R	M4	17101R	10051R	M4	41161R	44036R	M4	65091R	60052R	M4	80001AB	45051Y	M4
15071A	35001Y	M4	18071A	21051Y	M4	41181A	44021Y	M4	65151R	60050R	M4	80131RB	45064R	M4
15071R	35001R	M4	18071R	21051R	M4	41191A	44001Y	M4	70071A	91251Y	M4	80133AB	45063Y	M4
16071A	30050Y	M4	18111A	21056Y	M4	41201A	44027Y	M4	70131AB	91256Y	M4	94007A	44705	M4
16071R	30050R	M4	18111R	21056R	M4	46051C	44350C	M5	70131RB	91255R	M4	95161R	60056R	M4
17071A	10050Y	M4	20071A	25250Y	M4	47051C	44350C	M5	70133AB	91257Y	M4	96007A	60719	M4
17071R	10050R	M4	41141R	44032R	M4	2071R	60061R	M4	70133RB	91257R	M4			

GROTE

GROTE PART#	TRUCK-LITE PART #	MATCH LEVEL	GROTE PART#	TRUCK-LITE PART #	MATCH LEVEL	GROTE PART#	TRUCK-LITE PART #	MATCH LEVEL	GROTE PART#	TRUCK-LITE PART #	MATCH LEVEL	GROTE PART#	TRUCK-LITE PART #	MATCH LEVEL
460	97017	M5	16092	97811	M5	28481	97665	M5	43120	19724	M5	43823	10715	M5
470	97018	M5	16101	97808	M5	28483	97664	M5	43202	9199	M4	43830	15729	M5
830	97127	M4	16102	97818	M5	28493	97862	M5	43212	45720	M5	43850	19721	M5
6197	44308C	M5	16123	97822	M5	28663	97621	M5	43220	60117Y1	M5	43901	97960	M5
10025	97721	M4	16123	97836	M5	28663	97623	M5	43220	60126R	M5	43952	60722	M4
10083	97730	M5	16141	97637	M5	28663	97819	M5	43220	60126Y	M5	43952	60728	M4
10113	97732	M5	16142	97636	M5	28763	97865	M5	43220	60126Y1	M5	43952	60733	M4
10173	97823	M4	16153	97866	M5	28912	7226	M5	43220	60366R	M5	43962	15730	M5
10173	97828	M4	16191	97631	M5	28913	7225	M5	43220	60366Y	M5	43970	790	M4
10173	97849	M4	16200	97630	M5	29060	97845	M5	43220	60038R	M5	43980	15405	M4
10623	97748	M4	16202	97629	M5	40192	43	M5	43220	60268R	M5	43990	19720	M5
10623	97869	M5	16223	97827	M5	40193	43A	M5	43230	30720	M5	43990	19740	M5
11133	97718	M5	16223	97837	M5	40232	41	M5	43240	92522Y	M4	44010	270	M4
11293	97733	M5	16244	97627	M5	40233	41A	M5	43240	92644Y	M5	44010	275	M4
12004	7039	M5	16244	97839	M5	40641	98100	M5	43240	92646Y	M5	44030	276	M4
12010	97863	M5	16273	97861	M5	40650	98101	M5	43272	42722	M5	44040	97300	M5
12014	7044	M5	16284	97624	M5	40970	98132	M5	43343	44705	M5	44060	97302	M5
12020	97609	M4	16294	97625	M5	40980	98131	M5	43343	44705-1	M5	44421	92925	M5
12020	97610	M4	16304	97626	M5	40980	98134	M5	43362	60720	M5	44460	192-4	M4
12020	97835	M4	22002	97666	M5	41080	98107	M5	43362	60720-1	M5	44530	172	M5
12071	97807	M5	22012	97694	M4	41093	98110	M5	43370	15006R	M5	44540	173	M5
12072	97654	M5	22013	97693	M5	41111	98155	M5	43370	15006Y	M5	44601	8820	M4
12073	97653	M5	22013	97695	M5	41121	98153	M5	43370	15412	M5	44690	182	M5
12153	97688	M5	22013	97843	M5	41122	98154R	M5	43370	15414	M5	44700	183	M5
12164	7048	M5	22193	97829	M5	41133	98165	M5	43380	15008R	M5	44710	282	M5
12173	97817	M5	22232	97726	M5	41133	98168	M5	43380	15008Y	M5	44720	283	M5
12182	97816	M5	22233	97725	M5	41142	98175R	M5	43380	15414	M5	44730	286	M4
12183	97815	M5	28031	97612	M5	41143	32A	M5	43411	50	M5	44750	264	M4
12301	97673	M5	28031	97620	M5	41143	98175Y	M5	43424	97960	M5	44760	266	M5
12303	97847	M5	28032	97802	M5	41152	98176R	M5	43430	10414	M4	44810	262	M5
12331	97676	M5	28033	97618	M5	41153	98176Y	M5	43463	30708	M5	44820	263	M5
12333	97674	M5	28033	97872	M5	41160	98127	M5	43512	10729	M5	44860	263-4	M5
12333	97848	M5	28041	97623	M5	41170	98146	M5	43522	10730	M5	44891	285	M4
12813	97614	M5	28042	97622	M5	41210	98126	M5	43532	30728	M5	44900	97223	M5
13303	97718	M5	28042	97820	M5	41223	98167	M5	43572	40720	M4	45042	10028R1	M5
16023	97812	M5	28043	97819	M4	41223	98170	M5	43642	40715	M5	45043	10028Y1	M5
16032	97804	M5	28162	97611	M5	42103	60719	M5	43655	40722	M5	45062	30503R	M5
16033	97803	M5	28162	97619	M5	42131	15727	M5	43655	40725	M5	45063	30503Y	M5
16043	97635	M5	28443	97686	M5	42160	15736	M5	43673	9179	M5	45072	10028R	M5
16053	97809	M5	28451	97669	M5	42162	15736	M5	43673	1204A	M5	45072	10525R	M5
16053	97837	M5	28453	97668	M4	43012	9925	M4	43690	30504R	M5	45073	10028Y	M5
16063	97826	M4	28453	97846	M5	43012	9928	M4	43723	60719	M4	45073	10525Y	M5
16091	97806	M5	28461	97840	M5	43022	9288	M5	43782	19729	M4	45082	15506R	M4

Additional crosses are available online within the advanced catalog search section.

GROTE

GROTE PART#	TRUCK-LITE PART #	MATCH LEVEL	GROTE PART#	TRUCK-LITE PART #	MATCH LEVEL	GROTE PART#	TRUCK-LITE PART #	MATCH LEVEL	GROTE PART#	TRUCK-LITE PART #	MATCH LEVEL	GROTE PART#	TRUCK-LITE PART #	MATCH LEVEL
45083	15033Y	M4	46132	30285R	M5	47092	19006R	M5	50652	2751	M5	52691	40229R	M5
45092	19002R1	M5	46133	30285Y	M5	47092	19250R	M5	50652	3763	M5	52692	40029R	M5
45093	19002Y1	M5	46142	10288R	M5	47093	19006Y	M5	50662	2751	M5	52693	40058Y	M5
45152	21205R	M4	46143	10288Y	M5	47093	19250Y	M5	50662	3762	M5	52770	60206R	M5
45153	21205Y	M4	46282	26311R	M5	47102	3075	M5	50792	40757	M5	52772	4050	M4
45162	15201R	M5	46283	26311Y	M5	47102	30201R	M5	50802	40756	M5	52772	40202R	M5
45163	15201Y	M5	46302	1265	M5	47103	3075A	M5	50812	40742	M4	52773	40202Y	M5
45172	1101	M4	46303	1265A	M5	47103	30201Y	M5	50812	40743	M4	52783	4050A	M5
45172	1105	M4	46322	1155	M5	47112	30250R	M4	50812	40746	M4	52822	4026	M5
45172	26315R	M4	46322	1150	M5	47113	30250Y	M4	50812	40747	M4	52832	4025	M5
45172	1117	M4	46322	26354R	M5	47122	1050	M5	50820	40850	M4	52892	60202R	M5
45172	1117A	M4	46323	1155A	M5	47123	1050A	M5	50862	544	M4	52893	60202Y	M5
45173	1101A	M4	46323	1150A	M5	47162	21275R	M4	50862	541	M5	52902	4024Y106	M4
45173	1105A	M4	46323	26354Y	M5	47163	21275Y	M4	50872	80461R	M4	52912	4023Y106	M4
45173	26315Y	M4	46332	26353R	M5	47182	15050R	M4	50872	542	M5	52912	4023	M5
45182	10204R	M5	46333	26353Y	M5	47203	10051Y	M4	50882	80462R	M5	52912	4024	M5
45183	10204Y	M5	46333	26771Y	M5	47212	30276R	M4	50892	80463R	M5	52922	40282R	M5
45202	30206R	M5	46392	1570	M4	47222	10276R	M5	50902	4014	M5	52922	4050	M5
45203	30206Y	M5	46393	1570A	M4	47223	10276Y	M5	50902	4017	M5	52923	40282Y	M5
45232	14200R	M5	46412	15200R	M5	47232	10075R	M5	50912	4013	M5	52923	4050A	M5
45233	14200Y	M5	46412	1560	M5	47233	10075Y	M5	50912	4018	M5	52952	40242R	M5
45252	1555	M5	46413	15200Y	M5	47242	35200R	M5	50920	5061	M5	52952	4050	M5
45253	1555A	M5	46413	1560A	M5	47243	35200Y	M5	50927	5061	M5	52953	40242Y	M5
45262	1259	M5	46543	26765Y1	M5	47262	2673	M5	50942	4015	M5	52953	4050A	M5
45263	1259A	M5	46712	1264D	M5	47263	2673A	M5	50942	4018	M5	53000	2750	M5
45322	1075	M5	46742	19200R	M5	47352	21256R	M5	50952	4016	M5	53000	3812	M5
45323	1075A	M5	46742	1960	M5	47353	21256Y	M5	50952	4017	M5	53012	40028R	M5
45333	1312A	M5	46743	19200Y	M5	47372	10279R	M5	50972	4027	M5	53013	40028Y	M5
45412	1294	M5	46743	1960A	M5	47373	10279Y	M5	50992	5061	M5	53020	2750	M5
45413	1294A	M5	46772	1220	M5	47422	10288R	M4	52062	4091	M4	53020	2803	M5
45462	1233	M4	46773	1220A	M5	47423	10288Y	M4	52062	4094	M4	53032	2751	M4
45462	1205A	M4	46782	1203	M5	47462	35375R	M4	52063	4091A	M4	53032	3712	M4
45463	1233A	M4	46782	2660	M5	47463	35375Y	M4	52063	4094A	M4	53052	2751	M4
45463	1205	M4	46783	1203A	M5	47472	10050R	M4	52072	60253R	M5	53052	2702	M5
45503	25760Y	M5	46783	2660A	M5	47473	10050Y	M4	52072	60264R	M5	53053	2751A	M5
45512	1520	M5	46791	1211W	M5	47492	19275R	M5	52073	60255Y	M5	53053	2702A	M5
45513	1520A	M5	46792	1211	M5	47493	19275Y	M5	52152	40209R	M5	53062	22002R	M5
45522	1520HT	M5	46792	2660	M5	48072	902	M5	52153	4050A	M4	53063	2150A	M5
45523	1520AHT	M5	46793	1211A	M5	48072	910	M5	52153	40209Y	M5	53063	22002Y	M5
45562	30221R	M5	46793	1211AD	M5	48272	905	M5	52182	60283R	M5	53092	60083R	M5
45563	30221Y	M5	46793	2660A	M5	48282	905	M5	52182	6050	M5	53093	60083Y	M5
45811	10202C	M4	46813	1350A	M4	49002	26741R	M4	52183	60283Y	M5	53102	49202R	M5
45812	10202R	M4	46813	25761Y	M4	49062	1523	M4	52183	6050A	M5	53122	60050R	M5
45812	1050	M5	46832	21200R	M4	49082	1215	M4	52193	60215Y	M5	53123	60075Y	M5
45813	10202Y	M5	46833	21200Y	M4	49112	1508R	M5	52202	4550	M5	53132	548D	M5
45813	1050A	M5	46862	29203R	M4	49140	799	M4	52202	45202R	M5	53133	549AD	M5
45821	30200C	M5	46882	1507	M4	49142	10744R	M5	52203	4550A	M5	53163	2150A	M5
45822	3050	M4	46883	1507A	M4	49172	15745R	M5	52203	45202Y	M5	53182	44024Y	M5
45822	30200R	M5	46892	26313R	M4	49173	15745Y	M5	52233	45201Y	M5	53183	44877Y	M4
45822	30200R	M5	46893	26313Y	M4	49252	35200R	M4	52253	60015Y	M5	53212	44882R	M5
45823	3050A	M4	46913	25765Y	M5	49253	35200Y	M4	52323	60315Y	M4	53272	44322R	M5
45823	30200Y	M5	47032	21051R	M4	50132	90327R	M4	52383	60317Y	M4	53282	44038R	M5
45823	30200Y	M5	47033	21051Y	M4	50222	80302R	M5	52512	60215R	M5	53292	44036R	M4
45832	1052	M5	47051	1571W	M5	50222	80302Y	M5	52522	80335R	M5	53312	44202R	M4
45832	10205R	M5	47052	1571D	M5	50232	80334R	M5	52572	60002R	M5	53313	44203Y	M4
45833	1052A	M5	47053	1571AD	M5	50502	80339R	M5	52573	60002Y	M5	53313	44871Y	M4
45833	10205Y	M5	47063	25750Y	M5	50532	80324R	M5	52602	5060	M5	53323	44877Y	M4
45932	1264	M5	47072	21251R	M5	50542	80322R	M5	52602	4028	M5	53413	44201Y	M4
45933	1264A	M5	47072	21880R	M5	50630	2750	M4	52612	80336R	M5	53413	44881Y	M4
45993	26760Y	M4	47073	21251Y	M5	50630	70311	M4	52672	40215R	M5	53422	91244R	M5
46003	25062Y	M4	47073	21880Y	M5	50630	3863	M4	52672	40248R	M5	53422	91272R	M5
46072	21201R	M5	47082	15250R	M5	50642	2751	M5	52682	40048R	M5	53462	44030R	M4
46073	21201Y	M5	47083	15250Y	M5	50642	70310R	M5	52691	40222R	M5	53493	60315Y	M5

Additional crosses are available online within the advanced catalog search section.

GROTE

GROTE PART#	TRUCK-LITE PART #	MATCH LEVEL	GROTE PART#	TRUCK-LITE PART #	MATCH LEVEL	GROTE PART#	TRUCK-LITE PART #	MATCH LEVEL	GROTE PART#	TRUCK-LITE PART #	MATCH LEVEL	GROTE PART#	TRUCK-LITE PART #	MATCH LEVEL
53503	44887Y	M4	56000	3801	M4	62011	80340	M4	64440	97982	M4	67050	10403	M5
53513	44888Y	M4	56000	3802	M5	62021	92WD	M4	64441	650W	M4	67050	94902	M5
53592	66252R	M4	56000	3806	M5	62051	6060C	M4	64441	80364	M5	67050	94909	M5
53592	66882R	M4	56020	2801	M5	62061	6060C	M4	64461	650W-4	M5	67050	94916	M5
53593	60272Y	M4	56032	3711	M4	62091	4060C	M4	64491	630W4	M5	67050	94919	M5
53593	60872Y	M4	56052	2701	M5	62091	44350C	M4	64561	80438	M5	67050	94924	M5
53622	60256R	M4	56053	2701A	M5	62101	4060C	M4	64741	612W	M4	67090	94993	M5
53622	66256R	M4	56072	6503	M5	62111	60284C	M5	64801	613W	M4	68080	9104	M4
53623	60276Y	M5	56073	6503A	M5	62151	80344	M5	64890	97989	M4	68080	9160	M4
53702	5014K	M5	56083	6501A	M4	62171	40244	M5	64891	80395	M5	68080	9162	M4
53712	5013K	M5	60001	26335-1	M4	62171	40260	M5	64891	80392	M5	68100	9103	M5
53722	5016K	M4	60001	26335	M5	62171	40844	M5	64901	80498	M4	68110	9107	M4
53762	5315Y101	M5	60011	26371	M5	62181	40044	M5	64930	97980	M4	68130	9101	M5
53963	6050A	M4	60021	17001	M4	62181	40084	M5	64930	620H	M5	68170	9102	M5
53963	60891Y	M5	60021	17002	M4	62201	80345	M5	64931	80360-1	M5	68280	96904	M5
54012	2150	M5	60031	21004C	M4	62211	40204	M5	64931	80360	M5	68380	94940	M5
54043	10519Y1	M5	60081	9365W	M4	62231	60204C	M5	64931	80375	M5	68470	80974	M5
54132	6050	M4	60101	26331	M4	62231	60804C	M5	64940	630H	M5	68471	80970	M5
54133	6050A	M4	60151	26330	M5	62251	60004C	M5	64941	630W	M5	68472	80975	M5
54142	6050	M4	60191	17003	M4	62251	60084C	M5	64943	631W	M4	68473	80976	M5
54143	6050A	M4	60191	17200	M4	62321	40012	M5	65370	5050DK	M5	68474	80972	M5
54162	6050	M4	60251	26336	M5	62321	40212	M5	65530	5050DK	M5	68475	80971	M5
54163	6050A	M4	60261	15208	M5	62391	44206C	M4	65782	15041	M5	68680	95000	M5
54172	6050	M5	60271	15200C	M5	62391	44236C	M4	65790	15040	M5	69550	900Y73	M5
54173	6050A	M5	60280	15012	M4	62401	44350C	M4	66100	96959	M5	71152	797	M4
54332	4050	M4	60280	15013	M4	62421	40224	M4	66101	96970	M4	71422	798	M5
54333	4050A	M4	60280	15011	M5	62421	40004	M5	66110	96967	M4	71440	148-18500	M5
54342	4050	M5	60291	19206	M5	62421	40204	M5	66111	96968	M4	71450	148-28500	M5
54343	4050A	M5	60301	19200C	M5	62421	40262	M5	66122	97060	M4	73030	92904	M4
54362	4050	M4	60301	19206	M5	62441	40024	M5	66123	96953	M4	73040	92900	M5
54363	4050A	M4	60311	3613W	M5	62451	40004	M5	66123	97062	M4	73040	92901	M5
55092	81300R	M5	60311	80423C	M5	62561	6060C	M4	66125	96974	M4	73050	92903	M5
55220	70300	M4	60331	21204C	M4	62691	4060C	M5	66160	96960	M5	73080	92905	M5
55223	3850AA	M4	60341	15041	M4	62701	4060C	M4	66161	96973	M4	73090	92902	M4
55232	3711B	M4	60381	15040	M4	63381	80910	M4	66170	96979	M5	73090	92924	M4
55242	3753D	M5	60421	15205	M4	63391	80920	M4	66180	96975	M5	73100	92923	M4
55243	3753AD	M5	60581	84216C	M4	63491	884W	M4	66182	96954	M4	73110	92911	M4
55280	2750	M5	60601	15205	M5	63551	81380	M5	66201	96904	M5	73130	92916	M4
55280	3860	M5	60631	425WD	M5	63561	81360	M4	66202	96919	M5	73160	92918	M4
55290	2750	M5	61031	80490	M5	63571	81360	M4	66360	96930	M5	76121	387	M5
55290	3861	M5	61051	40206C	M5	63581	81360	M4	66800	94850	M5	76163	6822A	M5
55340	2753	M5	61141	44308C	M5	63591	81360	M4	66801	94964	M5	76223	92600Y	M5
55410	4742	M5	61161	80427	M5	63601	81360	M4	66801	94972	M5	76243	92601Y	M5
55420	4869	M4	61161	80482	M5	63611	81360	M4	66810	94932	M5	76451	92611C	M4
55450	4854	M4	61197	44308C	M5	63621	81360	M4	66811	94802	M5	76451	92612C	M4
55450	4754	M4	61261	80251C	M5	63641	81360	M4	66812	94962	M5	76452	92602R	M5
55450	81312Y	M5	61371	80418	M4	63651	81360	M4	66820	94853	M4	76453	92602Y	M5
55460	4855	M5	61371	80444	M4	63661	81360	M4	66830	94706	M4	76453	92602Y	M5
55470	4842	M5	61371	80442	M4	63751	81360	M4	66831	94897	M5	76455	92602B	M5
55572	40241R	M5	61431	40003	M4	63951	81374	M4	66840	94964	M5	76463	6822A	M5
55572	4050	M5	61451	44308C	M5	64021	653H	M5	66844	94882	M5	76483	6823A	M5
55573	40201Y	M5	61501	434WD	M5	64031	657W	M5	66851	94972	M5	76803	92524Y	M4
55573	40241Y	M5	61541	81350	M5	64071	675W	M5	66851	95477	M5	76803	92642Y	M4
55573	4050A	M5	61581	44207C	M4	64221	656W	M4	66930	94862	M5	76823	92685Y	M4
55612	81301R	M5	61611	80251C	M4	64231	652W	M5	66931	94736	M5	76933	92525Y	M4
55612	81301Y	M5	61861	80162C	M4	64231	653W	M5	66931	95410	M5	77013	92560	M5
55772	60201R	M5	61871	80162C	M4	64240	80860	M4	66931	97005	M5	77043	92513Y	M4
55772	6050	M5	61881	80251C	M5	64250	80870	M4	66950	94718	M5	77043	92513Y	M4
55773	60201Y	M5	61921	80162C	M4	64270	80810	M4	66981	94729	M5	77043	92513Y	M4
55773	6050A	M5	61931	80162C	M4	64271	80848	M4	67000	94926	M5	77053	92513Y	M4
55792	60001R	M5	61961	80162C	M5	64280	80820	M4	67002	94707	M4	77071	6611W	M4
55983	91271Y	M5	61971	44207C	M4	64281	80849	M4	67010	94925	M5	77072	6611R	M4
55993	91273Y	M5	61991	80162C	M5	64440	650H	M4	67011	94961	M5	77072	6801R	M4

Additional crosses are available online within the advanced catalog search section.

GROTE

GROTE PART#	TRUCK-LITE PART #	MATCH LEVEL	GROTE PART#	TRUCK-LITE PART #	MATCH LEVEL	GROTE PART#	TRUCK-LITE PART #	MATCH LEVEL	GROTE PART#	TRUCK-LITE PART #	MATCH LEVEL	GROTE PART#	TRUCK-LITE PART #	MATCH LEVEL
77072	6801W	M4	87270	50872	M4	91513	8939A	M4	94100	30050R	M4	40132-3	98003RB	M5
77072	6811R	M4	87860	50860	M4	91513	9074A	M4	94100	30401	M5	40132-4	98003R	M5
77073	92516Y	M4	87890	97100	M5	91581	9016W	M4	94110	9180	M5	40132-5	98003R1	M5
77073	6601A	M4	87890	97100-1	M5	91581	99176C	M4	94180	45700	M5	40133-3	31ADB	M4
77073	6601A	M4	87891	97101	M5	91582	9016	M4	94233	791	M5	40152-4	98006R	M5
77082	6600R	M4	87891	97101-1	M5	91582	9021	M4	97750	318	M4	40153-4	98006Y	M5
77083	6600A	M4	90011	80342	M5	91583	9016A	M4	99140	97031	M5	40232-5	41D	M5
77091	6601W	M4	90012	9029	M4	91583	9021A	M4	99140	97039	M5	40232-5	43D	M5
77091	6610W	M4	90012	99008R	M4	91683	99067Y	M5	99170	97944	M5	40233-5	41AD	M5
77092	6601R	M4	90012	9030	M4	91740	40700	M5	99180	97943	M5	40233-5	43AD	M5
77092	6610R	M4	90013	81300Y	M5	91880	10700	M5	99192	9006	M4	40641-3	98137	M5
77093	6600A	M4	90013	99008Y	M5	91961	99053C	M5	99502	97002	M5	40641-5	98105	M4
77093	6810A	M4	90051	9005W	M4	91962	9007	M5	99593	97945	M5	40650-3	98136	M5
77093	6601A	M4	90052	9005	M4	91963	9006A	M4	99802	99170R	M5	40650-5	98104-1	M5
77095	6601B	M4	90052	99111R	M4	91963	9007A	M4	99832	99169R	M5	41012-4	52TD	M5
77095	6610B	M4	90053	9005A	M4	91964	9007G	M4	99833	99169Y	M5	41013-4	52ATD	M5
77101	307W	M4	90053	99111Y	M4	91965	9007B	M4	99842	99168R	M5	41022-4	42D	M5
77102	307	M4	90092	8904	M4	91992	9057	M4	99843	99168Y	M5	41023-4	42AD	M5
77103	307A	M4	90093	8904A	M4	91992	9075	M4	99850	6606PS	M4	41033-4	54ATD	M5
77105	307B	M4	90121	9093W	M4	91993	9057A	M4	99880	6602PS	M4	41042-4	54TD	M5
77123	92534Y	M4	90122	9093	M5	91993	9075A	M4	99912	8861	M5	41142-1	98175RB	M5
77123	92539Y	M4	90123	9093A	M4	92070	10402	M5	99912	99063R	M5	41143-1	98175YB	M5
77123	6610A	M4	90132	9087	M4	92070	10702	M5	99913	8861A	M5	41152-1	98176RB	M5
77123	6820A	M5	90133	8977A	M4	92070	10714	M5	99913	99063Y	M5	41153-1	98176YB	M5
77133	6601A	M4	90133	9087A	M4	92070	10718	M5	10706201	794	M5	42141-3	15412	M5
77153	92642Y	M4	90152	99041R	M5	92120	30711	M4	12004-5	7039D	M5	43262-5	80720	M5
77193	92553Y	M4	90153	99041Y	M5	92120	30700	M5	12014-5	7044D	M5	43673-5	9179D	M5
77193	92555Y	M4	90162	99034R	M5	92150	30702	M4	12111-5	97660	M5	44810-5	262D	M5
77203	313A	M5	90163	99034Y	M5	92150	30704	M4	12113-5	97805	M5	44840-5	192D	M4
77263	92551Y	M5	90202	8933	M5	92150	30402	M5	12164-5	7048D	M5	44870-5	80594	M5
77273	92554Y	M4	90203	8933A	M4	92420	60120R	M4	12193-5	97800	M5	45022-5	1001D	M5
77273	6859A	M4	90302	9004	M4	92420	60120Y	M4	12201-5	7038	M5	45023-5	1001AD	M5
77353	92550Y	M4	90302	9003	M4	92420	60120Y1	M4	12201-5	7038D	M5	45263-5	1259AD	M5
77362	60122R	M4	90302	99039R	M5	92420	60122Y1	M5	12243-5	97655	M5	45412-5	1294D	M4
77362	60362R	M4	90303	9003A	M4	92420	60403	M5	12263-5	97751	M5	45413-5	1294AD	M4
77362	92551R	M4	90303	99039Y	M5	92420	60700	M5	12272-5	97831	M5	45512-5	1520D	M5
77363	60122Y	M4	90305	99039B	M5	92432	9342	M5	18302-5	7618	M5	45513-5	1520AD	M5
77363	60362Y	M4	90342	99074R	M4	92433	9342A	M4	26012-5	97693	M4	45822-5	30200R1	M5
77365	92551B	M4	90482	9079	M4	92520	15702	M5	28083-5	97749	M5	45823-5	30200Y1	M5
77422	60360R	M4	90502	9063	M4	92581	9021W	M4	28091-5	97680	M5	46412-5	15200R1	M5
77423	60360Y	M4	90761	99007C	M5	92691	9371W	M4	28093-5	97852	M5	46413-5	15200Y1	M5
77583	6600A	M5	90762	99007R	M4	92692	9371	M4	28293-5	97850	M5	46543-5	1320AD	M5
77593	6810A	M5	90763	99007Y	M4	92693	9371A	M4	28313-5	97678	M5	46712-5	1264	M5
77703	92523Y	M4	90783	99128Y	M4	92762	9372	M4	28323-5	97681	M5	46742-5	19200R1	M5
77703	92645Y	M5	90900	80564	M5	92763	9372A	M4	28323-5	97682	M5	46743-5	19200Y1	M5
77703	92646Y	M5	91042	8900	M5	92773	26762Y	M4	28373-5	7575	M5	46792-5	1211D	M5
77723	92645Y	M5	91043	8900A	M5	92773	99066Y	M4	28393-5	7217	M4	46793-5	1211AD	M5
77853	92565Y	M5	91051	80561	M5	92792	8948	M4	28393-5	7218	M4	46882-5	1507D	M5
77863	92565Y	M5	91152	8947	M4	92802	8947	M4	28402-5	7576	M5	46883-5	1507AD	M5
77873	92565Y	M5	91302	9049	M4	92920	10708	M5	28412-5	7577	M5	46892-5	26313Y1	M5
78260	9680A	M4	91302	9071	M4	92951	99172	M5	28423-5	7518	M5	46893-5	26313R1	M5
78322	90326R	M5	91311	99008C	M5	93163	9020A	M5	28433-5	7519	M5	50642-5	3756D	M5
78323	90326Y	M5	91380	15702	M5	93190	50831	M5	28472-5	97679	M4	50852-5	540D	M5
78333	30257Y	M5	91400	10700	M5	93252	9082	M5	28473-5	7555	M5	50972-5	4027D	M5
78343	10212Y	M5	91400	10713	M5	93253	9082A	M4	28473-5	7557	M5	51-9115-01	97094	M5
78363	21210Y	M4	91410	10704	M5	93291	80572	M5	28473-5	97750	M5	52-1005	50868	M5
78393	19205Y	M5	91482	99083R	M5	93301	80573	M5	28790-5	7599	M5	52302-5	535D	M5
78423	30271Y	M4	91502	8938	M4	93311	80572	M5	28792-5	7597	M5	52312-5	534D	M5
87040	97151	M5	91502	9079	M4	93313	80574	M5	28793-5	7596	M5	52513-1	60215YB	M4
87041	97153	M5	91503	8938A	M4	93321	8965W	M5	40052-4	47TD	M5	52892-5	60202R1	M5
87100	97160	M5	91503	9063A	M4	93400	14700	M5	40053-5	47ATD	M5	52893-5	60202Y1	M5
87101	97161	M5	91503	9078A	M4	94000	10404	M5	40072-5	45TD	M5	55220-5	70300-1	M5
87250	50896	M5	91503	9079A	M4	94010	10401	M5	40073-5	45ATD	M5	60101-5	26331-1	M5

Additional crosses are available online within the advanced catalog search section.

GROTE

GROTE PART#	TRUCK-LITE PART #	MATCH LEVEL	GROTE PART#	TRUCK-LITE PART #	MATCH LEVEL	GROTE PART#	TRUCK-LITE PART #	MATCH LEVEL	GROTE PART#	TRUCK-LITE PART #	MATCH LEVEL	GROTE PART#	TRUCK-LITE PART #	MATCH LEVEL
60251-5	26336-1	M5	63503-5	80522	M5	73150-5	329D	M5	G1042	3051	M5	G4603	2660A	M5
60581-3	84216C	M4	63511-5	80513	M5	82-0550	550	M5	G1043	3051A	M5	G5082	5061	M5
60591-3	84216C	M4	63523-5	80519	M5	82-0552	536	M5	G1052	1051	M5	G5092	5060	M5
60601-3	15205	M5	64003-5	80527	M4	82-0552	552	M5	G1053	1051A	M5	G5202	5061	M5
61091-5	9380SWD	M5	64061-5	80525	M4	82-1000	3121	M4	G1082	1075	M5	G5212	5060	M5
61491-5	549SWD	M5	64161-5	80526	M4	82-1001	97159	M5	G1083	1075A	M5	G5300	2750	M5
61581-3	44046C3	M4	64161-5	80553	M4	82-1002	50869	M5	G1092	30275R	M4	G6012	6051	M5
63151-5	610WD	M4	64181-5	80551	M4	82-1016	50888	M5	G1093	30275Y	M4	G6013	6051A	M5
63181-5	629WD	M5	64260-4	80888	M4	82-1020	50886	M5	G1902	1960	M5			
63191-5	628WD	M5	64261-4	80893	M5	82-1021	50885	M5	G1903	1960A	M5			
63201-5	627WD	M5	64261-4	640WK	M5	82-2006	50887	M5	G2102	2150	M5			
63211-5	80396	M5	64290-4	80800	M5	82-2140	97158	M5	G2103	2150A	M5			
63221-5	80397	M5	64291-4	644WK	M5	82-2159	50899	M5	G3002	3050	M4			
63231-5	80394	M5	64931-1	80360-B	M5	82-2160	9414BL	M5	G3002	3051	M5			
63441-4	80893	M5	65340-5	55554-1	M4	82-2163	9415BL	M5	G3003	3050A	M4			
63441-4	645WK	M5	65370-5	533DK	M5	82-2311	3131	M4	G3003	3051A	M5			
63451-4	80893	M5	65402-4	580K	M5	82-5800	52700	M5	G3092	3075	M5			
63455-4	80893	M5	65432-4	44390R	M5	90325Y	90325Y	M5	G3093	3075A	M5			
63481-5	80513	M5	65720-5	44390R1	M5	90971-5	80571	M5	G4002	4050	M5			
63481-5	80520	M5	65730-5	580DK	M5	92701-5	80560	M5	G4003	4050A	M5			
63501-5	80514	M5	72100-5	97361	M4	99167Y	99167Y	M5	G4022	4051	M5			
63501-5	80521	M5	72110-5	97360	M4	G1032	1050	M5	G4023	4051A	M5			
63503-5	80519	M5	73140-5	328D	M5	G1033	1050A	M5	G4602	2660	M5			

HELLA

HELLA PART#	TRUCK-LITE PART #	MATCH LEVEL	HELLA PART#	TRUCK-LITE PART #	MATCH LEVEL	HELLA PART#	TRUCK-LITE PART #	MATCH LEVEL	HELLA PART#	TRUCK-LITE PART #	MATCH LEVEL	HELLA PART#	TRUCK-LITE PART #	MATCH LEVEL
1539	81380	M5												

JETCO

JETCO PART#	TRUCK-LITE PART #	MATCH LEVEL	JETCO PART#	TRUCK-LITE PART #	MATCH LEVEL	JETCO PART#	TRUCK-LITE PART #	MATCH LEVEL	JETCO PART#	TRUCK-LITE PART #	MATCH LEVEL	JETCO PART#	TRUCK-LITE PART #	MATCH LEVEL
126-1011	1050	M5	126-1500A	1560A	M5	127-10211	1960	M5	127-43002	4050	M5			
126-1011A	1050A	M5	126-1900	1960	M5	127-10211A	1960A	M5	127-44050R	4050	M5			
126-1018	3075	M5	126-1900A	1960	M5	127-15000	1560	M5	127-60010	6050	M5			
126-1018A	3075A	M5	126-4040	4050	M5	127-15000A	1560A	M5	127-63002	6050	M5			
126-1019	1075	M5	126-4040A	4050A	M5	127-16002	3050	M5	127-63002A	6050A	M5			
126-1019A	1075A	M5	126-4041W	4060C	M5	127-16002A	3050A	M5	127-66010A	6050A	M5			
126-1211	2660	M5	126-4070	6050	M5	127-17002	1050	M5	127-66050A	6050A	M5			
126-1211A	2660A	M5	126-4070A	6050A	M5	127-17002A	1050A	M5	127-66050R	6050	M5			
126-1500	1560	M5	126-4071W	6060C	M5	127-40010	4050	M5						

MAXXIMA

MAXXIMA PART#	TRUCK-LITE PART #	MATCH LEVEL	MAXXIMA PART#	TRUCK-LITE PART #	MATCH LEVEL	MAXXIMA PART#	TRUCK-LITE PART #	MATCH LEVEL	MAXXIMA PART#	TRUCK-LITE PART #	MATCH LEVEL	MAXXIMA PART#	TRUCK-LITE PART #	MATCH LEVEL
20321R	2675	M5	M11256Y	1052A	M5	M16800Y	1075A	M5	M20330Y	2670A	M5	M20395R	2150	M5
20321Y	2675A	M5	M11260R	10286R	M5	M20320R	1560	M5	M20330Y	2674A	M5	M20395Y	2150A	M5
40800WU	44308C	M5	M11260Y	10286Y	M5	M20320R-01	15507R	M5	M20343R	35740R	M5	M23012R	2660	M5
M09100R	3050	M5	M11300R	1050	M5	M20320Y	1560A	M5	M20350R	1960	M5	M23012Y	2660A	M5
M09100Y	3050A	M5	M11300Y	1050A	M5	M20320Y-01	15507Y	M5	M20350R-01	19032R	M5	M2328R	2751	M5
M09105R	3075	M5	M11325R	1050	M5	M20323R	15050R	M5	M20350Y	1960A	M5	M2328Y	2751A	M5
M09105Y	3075A	M5	M11325Y	1050A	M5	M20327	15408	M5	M20350Y-01	19032Y	M5	M27340R	26270R	M5
M09200R	3050	M5	M16100R	1050	M5	M20328	15409	M5	M20355	19748	M5	M27340Y	26270Y	M5
M09200Y	3050A	M5	M16100Y	1050A	M5	M20330R	2150	M5	M20356	19728	M5	M34100R	3050	M5
M11201R	1075	M5	M16280R	1050	M5	M20330R	2670	M5	M20360Y	18050Y	M5	M34100Y	3050A	M5
M11201Y	1075A	M5	M16280Y	1050A	M5	M20330R	2674	M5	M20390R	2150	M5	M34260R	3050	M5
M11256R	1052	M5	M16800R	1075	M5	M20330Y	2150A	M5	M20390Y	2150A	M5	M34260RCL	3051	M5

Additional crosses are available online within the advanced catalog search section.

MAXXIMA

MAXXIMA PART#	TRUCK-LITE PART #	MATCH LEVEL	MAXXIMA PART#	TRUCK-LITE PART #	MATCH LEVEL	MAXXIMA PART#	TRUCK-LITE PART #	MATCH LEVEL	MAXXIMA PART#	TRUCK-LITE PART #	MATCH LEVEL	MAXXIMA PART#	TRUCK-LITE PART #	MATCH LEVEL
M34260Y	3050A	M5	M42322R	4050	M5	M43253CH	44708	M5	M50903	94840	M5	M63322RCL	6051	M5
M34260YCL	3051A	M5	M42322RCL	4051	M5	M43900	40403	M5	M50904	94897	M5	M63322Y	6050A	M5
M34600R	3075	M5	M42322Y	4050A	M5	M49700	45700	M5	M50950	94924	M5	M63322YCL	6051A	M5
M34600Y	3075A	M5	M42322YCL	4051A	M5	M50100-B	10700	M5	M50951	94964	M5	M63420R	6050	M5
M42100R	4050	M5	M42324	44350C	M5	M50102	10702	M5	M56100R	4050	M5	M63420Y	6050A	M5
M42100R-01	4050	M5	M42325	4060C	M5	M50105	10740	M5	M63100R	6050	M5	M63450R	6050	M5
M42100R-02	4050	M5	M42327	44236C	M5	M50300-B	30700	M5	M63100R-01	6050	M5	M63450Y	6050A	M5
M42100Y	4050A	M5	M42328R/Y	2750	M5	M50305	30713	M5	M63100Y	6050A	M5	M844820	84200C	M5
M42120R	44363R	M5	M42328RYCL	2750	M4	M50310	9179	M5	M63100Y-01	6050A	M5	M844821	84200C	M5
M42200R	4550	M5	M42400	44235C	M5	M50312	35720	M5	M63120Y	60315Y	M5	M90018Y	91271Y	M5
M42200Y	4550A	M5	M42450	4060C	M5	M50400-B	40700	M5	M63150	6060C	M5	M90061R	91272R	M5
M42201RCL	4551	M5	M42500R	4050	M5	M50405	44701	M5	M63200R	60360R	M5	M90081Y	91271Y	M5
M42205R	4550	M5	M42500Y	4050A	M5	M50410	44705	M5	M63200Y	60360Y	M5	MF-30A	97134-1	M5
M42205Y	4550A	M5	M42700R	44211R	M5	M50600-B	60700	M5	M63253	60750	M5	MWL-01	81360	M5
M42220	5060	M5	M42700Y	44211Y	M5	M50605	60703	M5	M63253CH	60750	M5			
M42320R	4050	M5	M43253	44705	M5	M50900	94993	M5	M63322R	6050	M5			

OPTRONICS

OPTRONICS PART#	TRUCK-LITE PART #	MATCH LEVEL	OPTRONICS PART#	TRUCK-LITE PART #	MATCH LEVEL	OPTRONICS PART#	TRUCK-LITE PART #	MATCH LEVEL	OPTRONICS PART#	TRUCK-LITE PART #	MATCH LEVEL	OPTRONICS PART#	TRUCK-LITE PART #	MATCH LEVEL
53CB	44350C	M5	A-91LW	96913	M5	LP-41CB	26371	M4	MC-57RB	10205R	M5	MCL-46AB	2660A	M5
A-11AB	9342A	M5	A-910B	791	M5	LP-42CB	26371	M4	MC-58AB	10202Y	M4	MCL-46RB	2660	M5
A-11RB	9342	M5	A-91RB	15200R	M5	LP-51CB	26371	M4	MC-58RB	10202R	M4	MCL-49AB	2674A	M5
A-13CB	60703	M5	A-91ZB	802	M5	LP-51CPG	26371	M4	MC-62AB	26312Y	M5	MCL-49AB	18050Y	M5
A13GB	60700	M5	AL-80AB	15033Y	M4	LP-52CB	26371	M4	MC-62RB	26312R	M5	MCL-49RB	2674	M5
A-194B	194	M5	AL-80RB	15033R	M4	LP-54CB	26371	M4	MC-65AB	19200Y	M5	MCL-53AB	3050A	M5
A-21AB	9075A	M5	AL-91AB	1560A	M5	LP-55B	80720	M5	MC-65RB	19200R	M5	MCL-53RB	3050	M5
A-21B	9075	M5	AL-91RB	1560	M5	LP-71CB	26336	M5	MC-66AB	1259A	M5	MCL-55AB	3050A	M5
A-21CB	9075W	M5	BK-42CB	26001	M5	LP-81BB	26335	M5	MC-66HAB	1259A	M4	MCL-55RB	3050	M5
A-2RB	8948	M5	BK-45BB	40720	M5	LP-91CB	15208	M5	MC-66RB	1259	M5	MCL-57AB	1050A	M5
A-33GB	45700	M5	BK-57BB	10725	M5	LPL-31CB	434WD	M5	MC-67AB	19002Y	M5	MCL-57RB	1050	M5
A-45BB	44750	M5	BK-70BB	60720	M5	LPL-41CB	26371	M4	MC-67RB	19002R	M5	MCL-58AB	10286Y	M5
A-45CB	94924	M5	BU-40CB	80342	M5	MC-11AB	1507A	M5	MC-67RPG	19002R	M4	MCL-58RB	10286R	M5
A-45GB	40700	M5	BU-41CB	80342	M5	MC-11RB	1507	M5	MC-68AB	1555A	M5	MCL-59AB	1052A	M5
A-45PB	94926	M5	BU-44CB	40004	M5	MC-25AB	30201Y	M5	MC-68RB	1555	M5	MCL-59RB	1052	M5
A-46PB	94924	M5	BU-45CB	40204	M5	MC-25RB	30201R	M5	MC-69AB	1555A	M4	MCL-65AB	1960A	M5
A-46PPG	94924	M5	BU-65CB	60004C	M5	MC-27AB	10203Y	M5	MC-69RB	1555	M4	MCL-65RB	1960	M5
A-47PB	94993	M5	BU-70CB	60204C	M5	MC-27RB	10203R	M5	MC-76AB	1233A	M5	MCL-66AB	35200Y	M5
A-49PB	94992	M5	BU-74CB	60004C	M4	MC-31AB	1264A	M5	MC-76RB	1233	M5	MCL-66RB	35200R	M5
A-54GB	30700	M5	BU-74CBTK	60004C	M4	MC-31AB2	1264A	M5	MC-81AB	2671A	M4	MCL-67AB	1960A	M5
A-54GK	30401	M5	BUL-43CB	4060C	M5	MC-31RB	1264	M5	MC-81RB	2671	M4	MCL-67RB	1960	M5
A-55GB	10700	M5	BUL-52CB	6060C	M5	MC-32AB	1222A	M5	MC-82AB	1101A	M5	MCL-69AB	19275Y	M5
A-55GK	10401	M5	BUL-53CB	4060C	M5	MC-32RB	1222	M5	MC-82RB	1101	M5	MCL-69RB	19275R	M5
A-56GB	10702	M5	BUL-72CB	6060C	M5	MC-35AB	1525A	M4	MC-85AB	1507A	M5	MCL-71AB	2675A	M5
A-57GB	10700	M5	BUL-78CB	66205C	M5	MC-35RB	1525	M4	MC-85RB	1507	M5	MCL-71RB	2675	M5
A-57GK	10401	M5	CB-22AB	1150A	M5	MC-36AB	1570A	M5	MC-91AB	15506Y	M5	MCL-75AB	6050A	M5
A-65B	19728	M5	CB-22RB	1150	M5	MC-36RB	1570	M5	MC-91RB	15506R	M5	MCL-75RB	6050	M5
A-65BPPG	19721	M5	CBL-22AB	1155A	M5	MC-37AB	1570A	M5	MC-92AB	15507Y	M5	MCL-76AB	1233A	M4
A-67CB	19739	M5	IL-21CB	549SWD	M5	MC-38AB	1264A	M5	MC-92RB	15507R	M5	MCL-76RB	1233	M4
A-67CBPG	19739	M5	IL-22CB	549SWD	M5	MC-38RB	1264	M5	MC-95AB	15200Y	M4	MCL-77AB	1960A	M5
A-70GB	60700	M5	IL-61CB	80482	M5	MC-42AB	1211AD	M5	MC-95AB24	15200Y	M4	MCL-77RB	1960	M5
A-78CB	60719	M5	IL-91CB	80351	M5	MC-42RB	1211A	M5	MC-95APG	15200Y	M4	MCL-81AB	2671A	M5
A-80BB	809	M5	LP-10SB	42722	M5	MC-52AB	30221Y	M5	MC-95RB	15200R	M4	MCL-81RB	2671	M5
A-86PB	94902	M5	LP-11CB	26331	M5	MC-52RB	30221R	M5	MCL-21AB	3075A	M5	MCL-86AB	12275Y	M5
A-91AB	1560A	M5	LP-15SB	42722	M4	MC-53AB	4050A	M5	MCL-21RB	3075	M5	MCL-86RB	12275R	M5
A-91BB	802	M5	LP-21CB	26330	M5	MC-53RB	4050	M5	MCL-23AB	1075A	M5	MCL-91AB	1560A	M5
A-91BOB	802	M5	LP-25SB	15730	M5	MC-55AB	10202Y	M5	MCL-23RB	1075	M5	MCL-91RB	1560	M5
A-91CB	791	M5	LP-31CB	434WD	M5	MC-55RB	10202R	M5	MCL-45AB	2660A	M5	MCL-95AB	1560A	M5
A-91GB	15702	M5	LP-31CPG	434WD	M5	MC-57AB	10205Y	M5	MCL-45RB	2660	M5	MCL-95APG	1560A	M4

Additional crosses are available online within the advanced catalog search section.

OPTRONICS

OPTRONICS PART#	TRUCK-LITE PART #	MATCH LEVEL	OPTRONICS PART#	TRUCK-LITE PART #	MATCH LEVEL	OPTRONICS PART#	TRUCK-LITE PART #	MATCH LEVEL	OPTRONICS PART#	TRUCK-LITE PART #	MATCH LEVEL	OPTRONICS PART#	TRUCK-LITE PART #	MATCH LEVEL
53CB	44350C	M5	A-49PB	94992	M5	A-91BOB	802	M5	A-91LW	96913	M5	BU-74CB	60004C	M4
A-11AB	9342A	M5	A-54GB	30700	M5	A-91CB	791	M5	A-91OB	791	M5	BU-74CBTK	60004C	M4
A-11RB	9342	M5	A-54GK	30401	M5	A-91GB	15702	M5	A-91RB	15200R	M5	BUL-43CB	4060C	M5
A-13CB	60703	M5	A-55GB	10700	M5				A-91ZB	802	M5	BUL-52CB	6060C	M5
A13GB	60700	M5	A-55GK	10401	M5				AL-80AB	15033Y	M4	BUL-53CB	4060C	M5
A-194B	194	M5	A-56GB	10702	M5				AL-80RB	15033R	M4	BUL-72CB	6060C	M5
A-21AB	9075A	M5	A-57GB	10700	M5				AL-91AB	1560A	M5	BUL-78CB	66205C	M5
A-21B	9075	M5	A-57GK	10401	M5				AL-91RB	1560	M5	CB-22AB	1150A	M5
A-21CB	9075W	M5	A-65B	19728	M5				BK-42CB	26001	M5	CB-22RB	1150	M5
A-2RB	8948	M5	A-65BPPG	19721	M5				BK-45BB	40720	M5	CBL-22AB	1155A	M5
A-33GB	45700	M5	A-67CB	19739	M5				BK-57BB	10725	M5	IL-21CB	549SWD	M5
A-45BB	44750	M5	A-67CBPG	19739	M5				BK-70BB	60720	M5	IL-22CB	549SWD	M5
A-45CB	94924	M5	A-70GB	60700	M5				BU-40CB	80342	M5	IL-61CB	80482	M5
A-45GB	40700	M5	A-78CB	60719	M5				BU-41CB	80342	M5	IL-91CB	80351	M5
A-45PB	94926	M5	A-80BB	809	M5				BU-44CB	40004	M5	LP-10SB	42722	M5
A-46PB	94924	M5	A-86PB	94902	M5				BU-45CB	40204	M5	LP-11CB	26331	M5
A-46PPG	94924	M5	A-91AB	1560A	M5				BU-65CB	60004C	M5	LP-15SB	42722	M4
A-47PB	94993	M5	A-91BB	802	M5				BU-70CB	60204C	M5	LP-21CB	26330	M5

PETERSON

PETERSON PART#	TRUCK-LITE PART#	MATCH LEVEL	PETERSON PART#	TRUCK-LITE PART#	MATCH LEVEL	PETERSON PART#	TRUCK-LITE PART#	MATCH LEVEL	PETERSON PART#	TRUCK-LITE PART#	MATCH LEVEL	PETERSON PART#	TRUCK-LITE PART#	MATCH LEVEL
320	2753	M5	143R	1052	M5	717R	91244R	M5	M164R	3050	M5	M417TA-2	4050A	M5
321	2756	M5	313R	2751	M5	717R	91274R	M5	M165A	3050A	M5	M417W-2	81360	M5
324	2752	M5	334-2	2751	M4	850A	4550A	M5	M165R	3050	M5	M420R	4050	M5
325	2752	M5	337-2	2750	M5	M120A	1155A	M5	M166A	3075A	M5	M420R-2	4050	M5
335	2750	M5	417C	4060C	M5	M120R	1155	M5	M166R	3075	M5	M420R-3	4050	M5
337	2750	M5	417R-5	4050	M5	M122XR	2671	M5	M173A	1052A	M5	M420R-5	4050	M5
415	6060C	M5	417YA	4050A	M5	M139A	2660A	M5	M173R	1052	M5	M420SA-1AMP	60360R	M5
540	5050DK	M5	421R	6050	M5	M139R	2660	M5	M188A	2150A	M5	M421A	6050A	M5
907	81374	M4	4258A-1	44211R	M5	M153A	1560A	M5	M188R	2150	M5	M4260A	4050A	M5
1460	80360	M5	4258A-1	44212R	M5	M153C	15205	M5	M2875A-2	60275Y	M5	M4260R-3	4050	M5
4321	4050A	M5	4258A-2	44211Y	M5	M153R	1560	M5	M313-2R	2751	M4	M450A	4550A	M5
4409	80360	M5	4258A-2	44212Y	M5	M161A	1560A	M5	M350A	60315Y	M5	M509	80394	M5
4468	80394	M5	426A	4050A	M5	M161R	1560	M5	M416	6060C	M5	M907	81360	M5
4477	4060C	M5	426R	4050	M5	M162A	1050A	M5	M417C	4060C	M5	V339-2	2751	M4
4486	60275Y	M5	450R	4050	M5	M162R	1050	M5	M417R	4050	M5	V410-2	2751	M4
4487	6050A	M5	505K	80893	M5	M163A	10286Y	M5	M417R-2	4050	M5			
1217A-1	4050A	M5	717A	91243Y	M5	M163R	10286R	M5	M417R-3	4050	M5			
143A	1052A	M5	717A	91273Y	M5	M164A	3050A	M5	M417TA	4050A	M5			

PHILLIPS

PHILLIPS PART#	TRUCK-LITE PART#	MATCH LEVEL	PHILLIPS PART#	TRUCK-LITE PART#	MATCH LEVEL	PHILLIPS PART#	TRUCK-LITE PART#	MATCH LEVEL	PHILLIPS PART#	TRUCK-LITE PART#	MATCH LEVEL	PHILLIPS PART#	TRUCK-LITE PART#	MATCH LEVEL
60-2201	80251C	M5	60-2211	80251C	M5	60-2251	80251C	M5						

PRECO

PRECO PART#	TRUCK-LITE PART#	MATCH LEVEL	PRECO PART#	TRUCK-LITE PART#	MATCH LEVEL	PRECO PART#	TRUCK-LITE PART#	MATCH LEVEL	PRECO PART#	TRUCK-LITE PART#	MATCH LEVEL	PRECO PART#	TRUCK-LITE PART#	MATCH LEVEL
112	92903	M5	270	92924	M5	1020	92911	M5	4050	92918	M5			
230	92900	M5	360	92903	M5	1040	92905	M5	ELT 248	92910	M5			
240	92901	M5	370	92923	M5	4028	92914	M5	LDA 50	92909	M5			
250	92902	M5	380	92904	M5	4030	92916	M5	SWM 43C	92907	M5			

Additional crosses are available online within the advanced catalog search section.

PRIMA TRONICS

PRIMA TRONICS PART#	TRUCK-LITE PART #	MATCH LEVEL	PRIMA TRONICS PART#	TRUCK-LITE PART #	MATCH LEVEL	PRIMA TRONICS PART#	TRUCK-LITE PART #	MATCH LEVEL	PRIMA TRONICS PART#	TRUCK-LITE PART #	MATCH LEVEL	PRIMA TRONICS PART#	TRUCK-LITE PART #	MATCH LEVEL
PT1000A	10202Y	M5	PT2101A	29203Y	M5	PT3000R-KIT	30503R	M5	PT5175	92902	M5	PTL1013R	1050	M5
PT1000A-KIT	10519Y	M5	PT2101R	29203R	M5	PT3000RS	30222R	M5	PT5412	262	M5	PTL1313A	10276Y	M5
PT1000BK	10729	M5	PT2102A	29202Y	M5	PT4000A	40282Y	M5	PT5413	263	M5	PTL1313R	10276R	M5
PT1000G	10700	M5	PT2102R	29202R	M5	PT4000BK	40720	M5	PT5453	172	M5	PTL1503A	15250Y	M5
PT1000GK	10401	M5	PT2200A	22202Y	M5	PT4000G	40700	M5	PT5454	173	M5	PTL1503A	1560A	M5
PT1000R	10202R	M5	PT2200R	22202R	M5	PT4000R	40282R	M5	PT5469	182	M5	PTL1503R	15250R	M5
PT1000R-KIT	10519R	M5	PT2601A	1259A	M5	PT4000RF	40229R	M5	PT5471	282	M5	PTL1503R	1560	M5
PT1001BK	10728	M5	PT2601A-LN	9093A	M5	PT4000RF	40233R	M5	PT5481	283	M5	PTL1508W	15205	M5
PT1002BK	10725	M5	PT2601R	1259	M5	PT4000R-KIT	40028R	M5	PT6000A	60202Y	M5	PTL1912A	1960A	M5
PT1002G	10702	M5	PT2601R-LN	9093	M5	PT4000W	40204	M5	PT6000BK	60720	M5	PTL1912R	1960	M5
PT1003BK	10410	M5	PT2602A	1211A	M5	PT4002BK	40715	M5	PT6000G	60700	M5	PTL3009A	30285Y	M5
PT1004G	10704	M5	PT2602A-LN	9007A	M5	PT4100R	40248R	M5	PT6000R	60202R	M5	PTL3009A	3050A	M5
PT1100A	10205Y	M5	PT2602R	1211	M5	PT4212RF	80334R	M5	PT6000R-KIT	60002R	M5	PTL3009R	30285R	M5
PT1100R	10205R	M5	PT2602R-LN	9007	M5	PT4212RF-LN	99008R	M5	PT6000W	60204C	M5	PTL3009R	3050	M5
PT1300A	10203Y	M5	PT2605A	1105A	M5	PT4902P	94902	M5	PT6500A	60215Y	M5	PTL3309A	30276Y	M5
PT1300R	10203R	M5	PT2700L	26330	M5	PT4924P	94924	M5	PT9805A	47A	M5	PTL3309R	30276R	M5
PT1500BK	15412	M5	PT2702L	26335	M5	PT4925P	94925	M5	PT9806A	98006Y	M5	PTL3606A	35200Y	M5
PT1500L	15208	M5	PT2703L	15011	M5	PT4926P	94926	M5	PT9806R	98006R	M5	PTL3606R	35200R	M5
PT1500R	15200R	M5	PT2704L	26331	M5	PT4992P	94992	M5	PT9807A	52A	M5	PTL4010R	44351R	M5
PT1500W	15200C	M5	PT3000A	30200Y	M5	PT4993P	94993	M5	PT9807R	52	M5	PTL4010RF	44363R	M5
PT1500Y	15200Y	M5	PT3000AF	30221Y	M5	PT4999P	94888	M5	PT9808A	45ATD	M5	PTL4018A	4050A	M5
PT1900A	19200Y	M5	PT3000AS	30222Y	M5	PT5000A	307A	M5	PT9808R	45TD	M5	PTL4018R	4050	M5
PT1900BK	19721	M5	PT3000BK	30728	M5	PT5000A-LN	9375A	M5	PT9810A	98175Y	M5	PTL5313A	2660A	M5
PT1900R	19200R	M5	PT3000G	30700	M5	PT5021	80360	M5	PT9810R	98175R	M5	PTL5313R	2660	M5
PT1900W	19200C	M5	PT3000GK	30401	M5	PT5023	629WD	M5	PT9832A	54A	M5	PTL6056A	6050A	M5
PT2100A	21201Y	M5	PT3000R	30200R	M5	PT5024	627WD	M5	PT9832R	54	M5	PTL6056R	6050	M5
PT2100R	21201R	M5	PT3000RF	30221R	M5	PT5110	92900	M5	PTL1013A	1050A	M5	PLT1508W	15205	M4

PSE AMBER / CODE 3

PSE AMBER CODE 3 PART#	TRUCK-LITE PART #	MATCH LEVEL	PSE AMBER CODE 3 PART#	TRUCK-LITE PART #	MATCH LEVEL	PSE AMBER CODE 3 PART#	TRUCK-LITE PART #	MATCH LEVEL	PSE AMBER CODE 3 PART#	TRUCK-LITE PART #	MATCH LEVEL	PSE AMBER CODE 3 PART#	TRUCK-LITE PART #	MATCH LEVEL
2100	92678Y	M5	660CCH	92611C	M5	Beacon	92565Y	M5	S51176M	99211C	M5	T03281	99213C	M5
420AH	92642Y	M5	660CH	92612C	M5	LLPMK-1K	92565Y	M4	T01553	99201C	M5	T07891	99216R	M5
420AMH	92644Y	M5	660CRH	92602R	M5	LXEXBIF-AH	92575Y	M5	T01554	99201Y	M5	T07892	99216Y	M5
420ASH	92644Y	M5	7000H	92674Y	M5	LXEXBIF-RH	92575R	M5	T01555	99201R	M5	T07901	99215R	M5
45BZAH	92692Y	M5	8005H	92645Y	M5	LXEXIF-AH	92574Y	M5	T01556	99201B	M5	T07902	99215Y	M5
45BZRH	92692R	M5	8005MH	92646Y	M5	LXEXIF-RH	92574R	M5	T01691	99202R	M5	T07911	99214R	M5
65BZAH	92691Y	M5	85BZAH	92690Y	M5	S50204M	99210Y	M5	T01692	99202B	M5	T07912	99214Y	M5
65BZRH	92691R	M5	85BZRH	92690R	M5	S50260M	99205C	M5	T01693	99202Y	M5	T09352	99200R	M5
660AH	92602Y	M5	B20	6822A	M5	S50424M	99205Y	M5	T02104	99203Y	M5	T09354	99200Y	M5
660CAH	92602Y	M5	B20 MAG	6823A	M5	S50857M	99208C	M5	T02134	99204Y	M5	X391H	92676Y	M5
660CBH	92602B	M5	B20 SUCTION	6823A	M5	S50858M	99209C	M5	T03271	99212C	M5	X394H	92677Y	M5

RE-TRAC

RE-TRAC CODE 3	TRUCK-LITE PART #	MATCH LEVEL	RE-TRAC CODE 3	TRUCK-LITE PART #	MATCH LEVEL	RE-TRAC CODE 3	TRUCK-LITE PART #	MATCH LEVEL	RE-TRAC CODE 3	TRUCK-LITE PART #	MATCH LEVEL	RE-TRAC CODE 3	TRUCK-LITE PART #	MATCH LEVEL
60	97848	M5	396	97865	M5	954	97820	M5	1151	97860	M5	2928	97661	M5
61	97671	M5	812	97800	M5	980	97814	M5	1152	97627	M5	3975	97665	M5
63	97673	M5	821	97659	M5	982	97814	M5	1152	97860	M5	3983	97828	M5
64	97847	M5	822	97800	M5	983	97803	M5	1156	97637	M5	3984	97829	M5
67	97671	M5	872	97817	M5	986	97804	M5	1159	97822	M5	21601	97644	M5
68	97673	M5	873	97815	M5	987	97831	M5	1160	97812	M5	273120	97681	M5
70	97990	M5	876	97816	M5	991	97606	M5	1731	97660	M5	608100	97862	M5
72	97670	M5	880	97803	M5	993	97609	M5	1732	97805	M5	1143H	97650	M5
73	97672	M5	880	97814	M5	1143	97811	M5	2640	97846	M5	1152-1	97860	M5
90	97872	M5	951	97820	M5	1145	97806	M5	2732	97678	M5	1156B	97636	M5
94	97802	M5	952	97819	M5	1146	97818	M5	2762	97852	M5	1157/1162	97861	M5
95	97872	M5	953	97819	M5	1148	97808	M5	2812	97850	M5	1157H	97866	M5

Additional crosses are available online within the advanced catalog search section.

RE-TRAC

RE-TRAC CODE 3	TRUCK-LITE PART #	MATCH LEVEL	RE-TRAC CODE 3	TRUCK-LITE PART #	MATCH LEVEL	RE-TRAC CODE 3	TRUCK-LITE PART #	MATCH LEVEL	RE-TRAC CODE 3	TRUCK-LITE PART #	MATCH LEVEL	RE-TRAC CODE 3	TRUCK-LITE PART #	MATCH LEVEL
1157H-IHN	97866	M5	872-4J5	97817	M5	880-4J5	97814	M5	980H	97614	M5	991J5	97606	M5
1159DV	97635	M5	872J5	97817	M5	880H	97614	M5	980J5	97814	M5	993-4	97609	M5
1159H	97809	M5	873-4	97815	M5	880J5	97803	M5	980SP	97814	M5	993J5	97609	M5
1159HL	97827	M5	873-4J5	97815	M5	880J5	97814	M5	980SPH	97614	M5	J502	97718	M5
1162H	97866	M5	873J5	97815	M5	881-4H	97615	M5	980SPHJ5	97614	M5	J510	97868	M5
1171H	97840	M5	876-4	97816	M5	881H	97615	M5	980SPJ5	97814	M5	J511	97868	M5
398B	97666	M5	876-4J5	97816	M5	96F	97653	M5	981-3H	97615	M5	J512	97718	M5
4MKSS	97823	M5	876J5	97816	M5	97F	97653	M5	981-3HJ5	97615	M5			
661-C	97732	M5	880-4	97803	M5	980-3	97814	M5	981H	97615	M5			
6MKSS	97823	M5	880-4	97814	M5	980-3H	97614	M5	983J5	97803	M5			
762V	97655	M5	880-4H	97614	M5	980-3HJ5	97614	M5	986J5	97804	M5			
872-4	97817	M5	880-4J5	97803	M5	980-3J5	97814	M5	987J5	97831	M5			

STAR HEADLAMP

STAR HEADLAMP PART#	TRUCK-LITE PART #	MATCH LEVEL	STAR HEADLAMP PART#	TRUCK-LITE PART #	MATCH LEVEL	STAR HEADLAMP PART#	TRUCK-LITE PART #	MATCH LEVEL	STAR HEADLAMP PART#	TRUCK-LITE PART #	MATCH LEVEL	STAR HEADLAMP PART#	TRUCK-LITE PART #	MATCH LEVEL
129	92710	M5	135L	99144Y	M5	20TD	92602Y	M5	6020S	92645Y	M5	920-3	99151Y	M5
295	99149Y	M5	181D	92713	M5	211R	6820A	M5	6020SM	92646Y	M5	920-5	92721	M5
297	99149Y	M5	181D4	92714	M5	211RM	6821A	M5	620-21	99191Y	M5	920-99	92720	M5
300	99145Y	M5	181-S	92701	M5	255TC	6601A	M5	820-21	99192Y	M5	ST3901-7	92715	M5
330	99147Y	M5	181Z	92702	M5	255TS	6610A	M5	820-21	99193Y	M5	VL22	92582	M5
333	99150C	M5	200A	92513Y	M5	300S	99146Y	M5	8300H	92668Y	M5	VL22	92583	M5
425	99148Y	M5	200AD	92513Y	M5	325L	99142Y	M5	8300S	92669Y	M5	VL22	92584	M5
3300	92730	M5	200AQ	92513Y	M5	3861-3	92731	M5	8400H	92670Y	M5			
3920	92551Y	M5	200B	92513Y	M5	3901-9	92715	M5	8400S	92671Y	M5			
3920	92551B	M5	200SQ	92516Y	M5	400A	92600Y	M5	8401H	92672Y	M5			
3930	92553Y	M5	201ZMQ	92539Y	M5	400A4	92601Y	M5	8401S	92673Y	M5			
3970	92552Y	M5	201ZQ	92534Y	M5	6020H	92642Y	M5	9200SMQ	92523Y	M5			
134L	99143Y	M5	20RI	6822A	M5	6020HM	92643Y	M5	9200SQ	92522Y	M5			

TECNIQ

TECNIQ PART#	TRUCK-LITE PART #	MATCH LEVEL	TECNIQ PART#	TRUCK-LITE PART #	MATCH LEVEL	TECNIQ PART#	TRUCK-LITE PART #	MATCH LEVEL	TECNIQ PART#	TRUCK-LITE PART #	MATCH LEVEL	TECNIQ PART#	TRUCK-LITE PART #	MATCH LEVEL
S10-0G00-1	10700	M5	S15-RR00-1	1560	M5	S30-AA00-1	3050A	M5	S90-0000-1	15417	M5	T40-RR00-1	4050	M5
S10-AA00-1	1052A	M5	S21-AA00-1	2660A	M4	S30-AC00-1	3051A	M5	S90-0B00-1	15731	M5	T60-0G00-1	60700	M5
S10-RR00-1	1052	M5	S21-AC00-1	2660A	M4	S30-RC00-1	3051	M5	S99-0010-1	94992	M5	T60-RR00-1	6050	M5
S15-0B00-1	802	M5	S21-RC00-1	2660	M4	S30-RR00-1	3050	M5	T40-0BT0-1	44701	M5			
S15-0C00-1	791	M5	S21-RR00-1	2660	M4	S35-AA00-1	3550A	M5	T40-0G00-1	40700	M5			
S15-AA00-1	1560A	M5	S30-0G00-1	30700	M5	S35-RR00-1	3550	M5	T40-RC00-1	4051	M5			

Additional crosses are available online within the advanced catalog search section.

UNIBOND

UNIBOND PART#	TRUCK-LITE PART #	MATCH LEVEL	UNIBOND PART#	TRUCK-LITE PART #	MATCH LEVEL	UNIBOND PART#	TRUCK-LITE PART #	MATCH LEVEL	UNIBOND PART#	TRUCK-LITE PART #	MATCH LEVEL	UNIBOND PART#	TRUCK-LITE PART #	MATCH LEVEL
BD2000	30729	M5	KT3260R	60083R	M5	LED1225-3A	1560A	M5	LED7250A	10276Y	M5	SE1225A	1560A	M5
BD2500	10725	M5	KT3405A	40028Y	M5	LED1225-3R	1560	M5	LED7250R	10276R	M5	SE1225R	1560	M5
BM1020B	15720	M5	KT3405R	40028R	M5	LED1225-6A	1560A	M5	MB2000	30728	M5	SE2000R	3050	M5
BM1020C	791	M5	KT4060A	45002Y	M5	LED1225-6R	1560	M5	MB2238	60720	M5	SE2238A	6050A	M5
BM1020CB	802	M5	KT4060R	45002R	M5	LED2000-4A	3050A	M4	MB2500	10729	M5	SE2238R	60283R	M5
BM1020CG	790	M5	KTL1224A	15033Y	M5	LED2000-4R	3050	M4	MB4000	40720	M5	SE2238R	6050	M5
BM1020R	15728	M5	KTL1225R	15033R	M5	LED2000-9A	3050A	M4	MB4060	45720	M5	SE2238W	6060C	M5
BM1020RB	15733	M4	KTL4040R	44357R	M5	LED2000-9R	3050	M4	ML2030A-CB	2675A	M5	SE2238W	60284C	M5
BM1020RG	15733	M5	KTL4040RSS	44351R	M5	LED2040A	2660A	M5	ML2030R-CB	2675	M5	SE2500A	1050A	M5
BM1021CB	15408	M5	KTL4041A	44024Y	M5	LED2040R	2660	M5	ML2040A	2660A	M5	SE2500R	1050	M5
BM1021CG	15406	M5	KTL4041R	44363R	M4	LED2237A	6050A	M4	ML2040R	2660	M5	SE4000A	40282Y	M5
BM1040B	19721	M5	KTL4042A	44023Y	M5	LED2238-13R	6050	M4	ML7250A	1075A	M5	SE4000A	4050A	M5
BM1040BB	19726	M5	KTL4042R	44363R	M4	LED2238-27A	6050A	M4	ML7250R	1075	M5	SE4000C	40203	M5
BM1040BC	19739	M5	KTL4045A	44023Y	M4	LED2238-63A	6050A	M4	PT6020	94902	M5	SE4000R	40282R	M5
BM2238-1	60722	M5	KTL4045R	44357R	M4	LED2238-63R	6050	M4	PT6020-3	93943	M5	SE4000R	4050	M5
CL3500A	1155A	M5	KTL4050RSS	44357R	M4	LED2500-12A	1050A	M5	PT9180	94926	M5	SE4000W	4060C	M5
CL3500R	1155	M5	KTL4060ASS	44023Y	M4	LED2500-12R	1050	M5	PT9181	94840	M5	SE4000W	40204	M5
CL3501A	1155A	M5	KTR2238A	60015Y	M5	LED2500-4A	1050A	M5	PT9530	94993	M5	SE4060A	4550A	M5
CL3501R	1155	M5	LB1020R	1508R	M5	LED2500-4R	1050	M5	RF1421A	98003Y	M5	SE4060A	45202Y	M5
FM4202RA	2750	M5	LB1030A	35740Y	M4	LED4000-19C	4060C	M4	RF1421R	98003R	M5	SE4060R	4550	M5
FM5203RA	2753	M5	LB1030R	35740R	M4	LED4000-56A	4050A	M4	RF2001A	45A	M5	SE4060R	45202R	M5
FM5403RA	2753	M5	LB1225R	15741R	M5	LED4000-56R	4050	M5	RF2001R	45	M5	SR2238A	60215Y	M5
GR1225	15702	M5	LB2000R	30740R	M5	LED4000-56R	44351R	M5	RF2012A	45A	M5	SR2238R	60215R	M5
GR2000	30700	M5	LB2000RSS	30742R	M5	LED4000-61A	4050A	M4	RF2012R	45	M5	SR2500A	1052A	M5
GR2001	30702	M5	LB2040R	1215	M4	LED4000-61R	4050	M5	RF2421A	54A	M5	SR2500R	1052	M5
GR2238	60700	M5	LB2500R	10744R	M5	LED4000A	4050A	M5	RF2421R	54	M5	SR4000R	40285R	M5
GR2239	60704	M5	LB2500RSS	10745R	M5	LED4040-56R	44363R	M5	RF3001A	47A	M5	SW2238A	60283Y	M5
GR2500	10713	M5	LB7250R	26741R	M4	LED4040-61R	44363R	M5	RF3001R	47	M5	SW2238C	60284C	M5
GR2501	10714	M5	LBL1225R	1560	M5	LED4040A	44223Y	M4	RF3012A	98006Y	M5	TL6400	5060	M5
GR2502	10708	M5	LBL2000R	3050	M5	LED4060-60A	45251Y	M5	RF3012R	98006R	M5			
GR2504	10700	M5	LED0750A	35001Y	M5	LED4060-60R	45258R	M5	RF3022A	41A	M5			
GR4000	40700	M5	LED0750R	35001R	M5	LED4060A	45251Y	M5	RF3022R	41	M5			
GR4060	45700	M5	LED1040-12A	1960A	M5	LED7000A	91243Y	M5	RF3023A	41A	M5			
KT3207	30404	M5	LED1040-12R	1960	M5	LED7000R	91244R	M5	RF3023R	41	M5			
KT3257	10414	M5	LED1040-6A	1960A	M5	LED7007A	91241Y	M5	SE1040A	1960A	M5			
KT3260A	60083Y	M5	LED1040-6R	1960	M5	LED7007R	91244R	M5	SE1040R	1960	M5			

VELVEC

VELVEC PART#	TRUCK-LITE PART #	MATCH LEVEL	VELVEC PART#	TRUCK-LITE PART #	MATCH LEVEL	VELVEC PART#	TRUCK-LITE PART #	MATCH LEVEL	VELVEC PART#	TRUCK-LITE PART #	MATCH LEVEL	VELVEC PART#	TRUCK-LITE PART #	MATCH LEVEL
700064	97843	M5	708005	97861	M5	708470	97872	M5	708521	97802	M5	723047	97828	M5
704068	97733	M5	708008	97866	M5	708471	97802	M5	708525	97837	M5	723065	97990	M5
704093	97674	M5	708020	97637	M5	708474	97611	M5	708526	97836	M5	723080	97718	M5
704095	97848	M5	708022	97861	M5	708476	97621	M5	709002	97805	M5	723083	97868	M5
704159	97675	M5	708046	97866	M5	708477	97622	M5	709004	97660	M5	748216	97869	M5
705038	97627	M5	708211	97840	M5	708478	97819	M5	709218	97863	M5	704040-5	97848	M5
705050	97860	M5	708212	97840	M5	708479	97820	M5	709276	97660	M5	704152-5	97672	M5
705102	97812	M5	708331	97827	M5	708501	97803	M5	712479	97681	M5	704153-5	97670	M5
705104	97811	M5	708441	97803	M5	708502	97814	M5	712643	97862	M5			
705105	97806	M5	708442	97804	M5	708503	97804	M5	713120	97665	M5			
705107	97632	M5	708444	97814	M5	708508	97815	M5	713121	97664	M5			
705332	97837	M5	708448	97606	M5	708509	97817	M5	713444	97686	M5			
705333	97822	M5	708449	97831	M5	708510	97816	M5	713445	97829	M5			
705334	97635	M5	708457	97614	M5	708515	97819	M5	714620	97688	M5			
708001	97636	M5	708467	97618	M5	708516	97820	M5	714721	97687	M5			
708003	97637	M5	708468	97619	M5	708520	97872	M5	721090	97846	M5			

Additional crosses are available online within the advanced catalog search section.

VSM

VSM PART#	TRUCK-LITE PART #	MATCH LEVEL	VSM PART#	TRUCK-LITE PART #	MATCH LEVEL	VSM PART#	TRUCK-LITE PART #	MATCH LEVEL	VSM PART#	TRUCK-LITE PART #	MATCH LEVEL	VSM PART#	TRUCK-LITE PART #	MATCH LEVEL
VSM1010	1050	M5	VSM1045A	3075A	M5	VSM1900	1960	M5	VSM2803	2750	M5	VSM4801	2753	M5
VSM1011	1051	M5	VSM1050	1075	M5	VSM1905AX	1960A	M5	VSM3074	2751	M5	VSM6064	6050	M5
VSM1015AX	1050A	M5	VSM1055	1075	M5	VSM1905X	1960	M5	VSM3704A	2751A	M5	VSM6464	6050	M5
VSM1015X	1050	M5	VSM1055A	1075A	M5	VSM2101	2150	M5	VSM3812	2750	M5	VSM64644	6050	M5
VSM1030	3050	M5	VSM1203	2660	M5	VSM2105	2150	M5	VSM4064	4050	M5	VSM6464rc	6051	M5
VSM1035AX	3050A	M5	VSM1255AX	2660A	M5	VSM2105A	2150A	M5	VSM4464	4050	M5			
VSM1035X	3050	M5	VSM1255X	2660	M5	VSM2311	2150	M5	VSM44644	4050	M5			
VSM1040	3075	M5	VSM1500	1560	M5	VSM2702	2751	M5	VSM4464rc	4051	M5			
VSM1045	3075	M5	VSM1505X	1560	M5	VSM2702A	2751A	M5	VSM4564	4550	M5			

WAGNER

WAGNER PART#	TRUCK-LITE PART #	MATCH LEVEL	WAGNER PART#	TRUCK-LITE PART #	MATCH LEVEL	WAGNER PART#	TRUCK-LITE PART #	MATCH LEVEL	WAGNER PART#	TRUCK-LITE PART #	MATCH LEVEL	WAGNER PART#	TRUCK-LITE PART #	MATCH LEVEL
795	80564	M5	7216	270	M5	7410	256	M5	1255/H1	80563	M5	852/5X	242	M5
7210	250	M5	7220	282	M5	7410	286	M5	1255/H3	80571	M5			
7210	262	M5	7310	263	M5	7410	97201	M5	2470/H2	80561	M5			
7210	97231	M5	7316	275	M5	7510	245	M5	795X	80564	M5			
7212	97210	M5	7320	283	M5	1210/H3	80560	M5	850/5X	243	M5			

WHELEN

WHELEN PART#	TRUCK-LITE PART #	MATCH LEVEL	WHELEN PART#	TRUCK-LITE PART #	MATCH LEVEL	WHELEN PART#	TRUCK-LITE PART #	MATCH LEVEL	WHELEN PART#	TRUCK-LITE PART #	MATCH LEVEL	WHELEN PART#	TRUCK-LITE PART #	MATCH LEVEL
21	92565Y	M5	2004BLAM	6600MA	M5	5020-0000-10	99171R	M5	68-3182182-20099227B		M5	EXT5	92847	M5
02-0363445-00	92833	M5	2012BHAM	6601MA	M5	5020-0000-20	99171Y	M5	68-3182182-30099227C		M5	H50ASN12	60-50124	M5
1000-1100-20	90325Y	M5	2012BLAM	6600MA	M5	5025-0000-00	26724	M5	68-3182182-50099227R		M5	MIRRORMT	92833	M5
1002-0000-20	99167Y	M5	2015BHAM	6601MA	M5	5050-1400-10	26354R	M5	68-3182183-10099226Y		M5	MKC29S	92687Y	M5
1003-0000-10	99168R	M5	2015BLAM	6810MA	M5	5050-1400-20	26354Y	M5	68-3182183-20099226R		M5	RB6PAM	6823A	M5
1003-0000-20	99168Y	M5	2022BHAM	6811MA	M5	68-1141474-10A99224Y		M5	68-3182183-30099226C		M5	S225CC	92844	M5
1004-0000-10	99169R	M5	2022BLAM	6810MA	M5	68-1983816-10	99228Y	M5	68-3182183-50099226B		M5	S30HACP	92846	M5
1004-0000-20	99169Y	M5	212650-02	92565Y	M4	68-1983817-10	99230Y	M5	7000-0000-01	97223	M5	S660CCCC	92845	M5
1010-1120-10	90327R	M5	212660-02	92565Y	M4	68-1983817-20	99230B	M5	8004-0000-30	99172	M5	SLPMMAA	92585	M5
1010-1120-20	90327Y	M5	5000-1400-10	26353R	M5	68-1983817-30	99230C	M5	8005-1000-30	81350	M5	STPKT54S	92841	M5
1020-1100-10	90326R	M5	5000-1400-20	26353Y	M5	68-1983817-50	99230R	M5	9M148000	92687Y	M5	STPKT55S	92842	M5
1020-1100-20	90326Y	M5	5002-0000-10	99170R	M5	68-2141859-10E99218Y		M5	9M2LAA	92687Y	M5	VB247AAA	92685Y	M5
2004BHAM	6601MA	M5	5002-0000-20	99170Y	M5	68-3182182-10099227Y		M5	9MCPAA	99229Y	M5	VB447AAA	92684Y	M5

Truck-Lite Part No. Page No.

0079	321
00791	321
00792	322
00793	322
00794	320
00798	320
00799	320
00802	321
00808	325
00809	322
00814	320
00815	336
00816	336
00817	325
07022	347
07168	350
32	442
41	441
43	441
45	440
47	440
52	440
54	441
57	441
102	462
125	313
131	462
172	304
173	304
182	304
183	304
190	312
191	312
192	312
194	313
195	313
242	305
243	305
245	309
250	306

Truck-Lite Part No. Page No.

256	306
262	304
263	305
270	307
275	307
276	307
282	304
283	304
285	307
536	309
540	23
541	23
548	30
550	309
794	445
797	445
798	445
801	333
900	462
901	462
902	464
903	464
905	464
910	464
920	464
950	83
955	84
1023	464
1050	112
1051	112
1052	112
1053	113
1058	112
1070	113
1075	152
1076	152
1101	123
1102	123
1105	123
1116	115

Truck-Lite Part No. Page No.

1150	149
1155	150
1203	135
1211	136
1213	136
1215	161
1216	161
1222	136
1233	145
1259	147
1264	147
1319	115
1506	123
1507	123
1555	146
1560	121
1561	121
1570	132
1571	135
1924	312
1960	128
1961	128
2150	142
2152	142
2584	306
2634	305
2660	133
2661	133
2671	131
2673	128
2674	133
2675	130
2701	76
2702	77
2750	79
2751	76
2752	82
2753	83
2756	83
2758	83

Truck-Lite Part No.	Page No.	Truck-Lite Part No.	Page No.	Truck-Lite Part No.	Page No.
2759	83	4027	42	6502	25
2801	79	4028	41	6503	53
2803	81	4050	18	7021	294
3050	105	4051	18	7038	426
3051	105	4053	18	7039	426
3053	105	4058	18	7044	426
3058	105	4091	64	7048	431
3070	105	4093	64	7223	421
3075	151	4094	64	7224	421
3076	151	4095	64	7268	421
3121	399	4550	32	7269	421
3550	128	4558	31	7332	286
3612	23	4701	86	7450	432
3616	23	4702	86	7460	424
3701	76	4710	82	7519	424
3702	77	4742	86	7555	422
3710	76	4754	86	7575	424
3711	76	4800	85	7618	419
3712	77	4801	85	7619	419
3753	77	4805	85	8006	294
3754	78	4808	93	8007	294
3755	77	4810	85	8008	294
3756	78	4854	78	8140	204
3801	79	4854	78	8150	204
3802	79	4855	78	8155	206
3806	79	5013	43	8160	206
3810	81	5014	43	8170	206
3812	81	5015	41	8180	205
3850	80	5016	41	8192	206
3854	82	5023	43	8193	205
3860	79	5024	43	8810	299
3861	80	5070	41	8812	300
3862	81	5071	41	8820	299
3863	81	5072	41	8830	300
4015	44	5073	41	8850	300
4016	44	6050	29	8861	294
4017	42	6051	29	8900	291
4018	42	6053	29	8909	286
4023	42	6058	28	8918	290
4024	42	6500	54	8919	287

Truck-Lite Part No. Page No.

8923	292
8930	291
8933	289
8936	286
8937	289
8938	294
8943	286
8945	286
8946	289
8947	291
8948	294
8960	294
8974	287
9001	290
9004	294
9005	290
9006	289
9007	291
9016	287
9021	287
9029	286
9041	286
9049	293
9057	291
9059	290
9063	294
9071	293
9072	293
9077	289
9079	294
9081	286
9082	290
9083	294
9087	289
9093	289
9101	376
9102	377
9103	377
9104	377
9105	376

Truck-Lite Part No. Page No.

9120	346
9120	347
9160	377
9162	377
9179	342
9180	346
9180	347
9183	362
9185	363
9186	310
9187	310
9190	344
9191	464
9196	464
9260	361
9288	343
9291	343
9341	286
9342	290
9371	291
9372	292
9382	294
9384	294
9462	366
9463	366
9464	382
9465	383
9466	383
9467	377
9469	382
9470	364
9520	346
9521	346
9522	346
9523	346
9536	90
9537	90
9674	302
9676	292
9702	302

Truck-Lite Part No. Page No.

9720	287
10133	334
10136	334
10250	108
10400	318
10401	351
10402	351
10402	351
10403	351
10404	351
10410	318
10412	319
10413	320
10414	319
10700	350
10704	350
10706	350
10708	350
10713	350
10714	351
10715	321
10718	351
10719	350
10720	318
10721	318
10722	319
10724	318
10725	319
10727	318
10728	318
10729	318
10730	318
10731	319
10731	319
10732	320
10732	321
10738	319
10740	350
10800	331
12723	321

Truck-Lite Part No.	Page No.	Truck-Lite Part No.	Page No.	Truck-Lite Part No.	Page No.
12724	321	19729	327	30712	333
12725	321	19737	327	30713	333
14700	352	19738	328	30715	332
14701	352	19739	327	30720	332
15063	123	19740	327	30721	333
15401	323	19748	328	30722	333
15404	323	19750	328	30727	330
15405	323	20302	272	30728	331
15406	323	20308	272	30729	331
15407	323	21720	329	30730	332
15408	323	21721	329	30731	331
15409	323	21722	329	33702	353
15412	324	26001	271	33705	353
15414	324	26002	330	33710	334
15415	122	26380	330	33711	335
15416	122	26723	330	33712	334
15417	119	26724	330	33715	335
15418	119	27004	224	33720	353
15603	121	27009	225	33725	353
15613	121	27010	225	33800	335
15702	352	27011	225	33805	336
15720	323	27012	224	33810	335
15727	324	30133	334	35720	336
15728	324	30136	334	36705	334
15729	324	30400	332	36710	336
15730	324	30401	352	36711	336
15731	325	30402	353	40003	275
15732	324	30403	331	40004	184
15733	324	30404	333	40012	184
15736	322	30405	333	40023	276
17720	326	30407	330	40024	184
19720	327	30410	332	40044	183
19721	327	30700	352	40071	184
19721	329	30701	352	40203	275
19722	328	30702	353	40204	184
19723	328	30704	353	40207	275
19724	326	30706	352	40211	275
19726	327	30707	352	40212	184
19726	329	30708	332	40223	276
19728	327	30711	352	40224	184

Truck-Lite Part No. Page No.

40227	275
40244	183
40260	183
40261	183
40262	184
40306	184
40403	354
40626	90
40627	90
40637	90
40638	90
40680	339
40681	339
40700	354
40701	354
40702	354
40703	354
40715	337
40719	338
40720	336
40721	337
40722	339
40725	337
40726	338
40730	339
40742	91
40743	91
40746	91
40747	91
40748	92
40749	92
40754	92
40755	92
40756	91
40757	91
40758	93
40759	93
40762	94
40763	94
40790	93

Truck-Lite Part No. Page No.

40791	93
40802	59
40803	59
40804	59
40805	59
40809	93
40810	337
40812	59
40819	354
40850	94
40894	94
42722	343
44700	354
44701	354
44705	338
44708	338
44709	338
44710	354
44808	92
44809	92
45004	187
45024	187
45204	187
45323	340
45333	340
45700	354
45701	354
45720	340
45721	340
45721	340
45740	95
45741	95
45742	95
45743	95
50133	392
50151	392
50204	393
50205	393
50208	392
50209	392

Truck-Lite Part No. Page No.

50210	392
50211	392
50230	392
50231	392
50242	392
50243	392
50250	393
50251	393
50266	394
50267	394
50300	395
50301	395
50302	394
50303	396
50304	396
50305	396
50307	396
50308	395
50310	396
50319	397
50321	397
50322	397
50331	397
50334	395
50335	395
50341	395
50342	394
50343	394
50344	394
50345	394
50350	397
50351	396
50356	397
50367	395
50368	395
50373	396
50374	396
50375	396
50376	396
50381	397

Truck-Lite Part No.	Page No.	Truck-Lite Part No.	Page No.	Truck-Lite Part No.	Page No.
50382	397	50872	407	60723	340
50388	394	50875	405	60724	340
50400	398	50878	404	60728	341
50401	398	50879	404	60729	341
50600	398	50882	406	60730	341
50601	398	50883	406	60731	341
50602	401	50885	409	60733	341
50606	400	50886	406	60737	342
50607	400	50887	409	60738	342
50608	401	50888	406	60789	317
50609	401	50889	405	70300	80
50800	398	50890	405	70311	80
50801	398	50892	405	70352	85
50805	404	50895	405	70353	85
50806	404	50896	406	70356	85
50807	406	50898	404	70357	85
50808	406	50899	405	77825	452
50809	406	51342	394	80202	208
50816	401	51343	394	80203	207
50820	400	51344	394	80204	210
50830	401	51345	394	80205	210
50831	339	51355	394	80206	210
50832	400	51356	394	80207	210
50840	402	52700	375	80208	229
50841	403	52733	392	80209	210
50842	403	52751	392	80240	204
50843	402	55650	471	80275	226
50845	401	55664	471	80304	185
50846	403	55665	471	80340	185
50847	403	60403	355	80342	185
50848	402	60700	355	80344	185
50850	400	60701	355	80345	185
50860	407	60703	355	80350	276
50861	407	60704	355	80351	276
50863	407	60705	355	80352	276
50865	407	60708	355	80353	276
50866	407	60718	342	80354	277
50867	407	60719	342	80355	209
50868	407	60720	340	80355	277
50869	407	60722	340	80360	207

Truck-Lite Part No. Page No.

80364	207
80374	208
80389	231
80394	209
80395	209
80396	209
80397	209
80427	277
80444	282
80491	210
80492	210
80494	210
80498	210
80513	231
80514	230
80519	230
80520	231
80521	230
80522	230
80525	229
80526	229
80560	296
80561	296
80562	296
80563	296
80564	296
80567	292
80568	292
80569	292
80571	296
80572	290
80573	290
80574	290
80579	292
80580	292
80594	459
80596	297
80597	297
80598	297
80599	297

Truck-Lite Part No. Page No.

80602	344
80604	298
80700	298
80720	343
80722	343
80800	236
80805	237
80810	236
80820	236
80830	383
80831	383
80839	383
80840	234
80844	234
80848	237
80849	237
80860	239
80867	76
80870	239
80873	233
80874	233
80875	233
80878	232
80879	232
80880	232
80888	239
80893	238
80898	383
80900	235
80910	235
80920	235
80930	383
80970	234
80971	234
80972	234
80973	234
80974	234
80976	383
80983	233
80984	233

Truck-Lite Part No. Page No.

80985	233
80988	232
80989	232
80990	232
81100	196
81105	196
81110	196
81240	199
81245	199
81250	199
81255	199
81260	200
81261	200
81270	199
81290	199
81291	199
81295	199
81350	280
81360	199
81365	199
81374	199
81380	199
81385	199
81390	199
81391	199
81395	199
81500	202
81510	202
81520	202
81560	201
81701	200
81702	200
81704	200
81711	200
81712	200
81714	200
84715	203
84720	228
84740	228
84764	228

Truck-Lite Part No.	Page No.	Truck-Lite Part No.	Page No.	Truck-Lite Part No.	Page No.
87357	391	92101	39	93906	381
87358	391	92547	302	93945	382
88100	389	92711	299	94236	364
88300	390	92715	299	94237	368
88301	391	92716	303	94609	367
88303	391	92720	301	94624	367
88307	391	92721	301	94706	365
88308	389	92722	296	94707	369
88338	389	92773	344	94718	367
88342	391	92800	301	94727	360
88367	390	92808	347	94729	360
88368	390	92810	297	94736	367
88372	390	92816	344	94750	365
88373	391	92855	244	94751	365
88377	391	92877	326	94759	369
88385	391	92878	326	94760	366
88601	384	92880	329	94766	369
88701	384	92882	326	94768	374
88703	384	92883	297	94769	365
88750	386	92900	456	94770	365
88751	386	92901	456	94781	382
88810	384	92902	456	94782	382
88820	384	92903	457	94789	365
88892	385	92904	457	94802	374
88896	385	92905	457	94811	361
88900	386	92907	459	94812	361
88902	389	92909	457	94813	361
88905	386	92910	456	94821	360
88910	387	92911	456	94837	373
88911	388	92914	458	94838	373
88915	387	92916	458	94839	374
88930	387	92918	458	94840	374
88931	388	92923	458	94841	374
88932	387	92924	457	94848	372
88962	386	92925	459	94850	372
89751	386	92927	458	94851	373
89810	385	92932	456	94853	366
90251	460	92933	456	94854	372
91150	465	92934	456	94861	367
92100	39	93745	367	94862	367

Truck-Lite Part No. Page No.

94865	370
94868	373
94882	374
94888	368
94892	382
94897	370
94898	382
94902	372
94909	372
94916	372
94919	372
94920	372
94922	366
94923	364
94924	373
94925	375
94926	375
94931	374
94932	365
94937	376
94938	376
94940	376
94948	375
94949	375
94954	361
94961	375
94962	375
94964	373
94966	367
94972	372
94991	373
94992	373
94993	374
95001	369
95002	369
95051	366
95119	362
95121	364
95122	364
95123	364

Truck-Lite Part No. Page No.

95124	364
95125	364
95220	369
95306	368
95332	360
95399	369
95400	370
95407	377
95410	368
95415	377
95424	369
95450	379
95451	379
95452	379
95453	379
95454	379
95455	379
95456	379
95457	379
95460	378
95461	378
95462	378
95463	378
95464	378
95465	378
95466	378
95467	378
95809	390
95846	370
95879	391
95910	345
95911	345
96106	365
96107	365
96108	365
96193	451
96259	451
96260	451
96511	399
96512	399

Truck-Lite Part No. Page No.

96630	220
96630	221
96630	370
96820	303
96830	220
96830	370
96927	371
96928	382
96930	371
96932	371
96934	371
96936	371
96953	380
96953	381
96954	380
96955	380
96955	381
96959	381
96960	380
96960	381
96966	382
96967	380
96969	382
96970	381
96973	380
96973	381
96974	380
96974	381
96975	380
96975	381
96978	382
96979	382
97002	360
97003	402
97005	368
97006	368
97011	403
97029	465
97029	470
97034	347

Truck-Lite Part No.	Page No.	Truck-Lite Part No.	Page No.	Truck-Lite Part No.	Page No.
97035	347	97254	307	97621	427
97036	347	97270	308	97622	427
97038	347	97272	308	97623	427
97039	348	97282	451	97624	416
97046	348	97302	311	97627	413
97050	348	97334	338	97628	413
97060	380	97337	338	97629	413
97060	381	97340	363	97630	413
97061	380	97342	363	97632	412
97061	381	97344	362	97633	414
97062	380	97345	363	97635	415
97062	381	97349	363	97636	415
97073	348	97364	362	97644	412
97079	348	97365	363	97650	418
97080	348	97366	362	97653	420
97093	348	97376	465	97654	420
97094	348	97377	468	97655	420
97100	451	97377	468	97656	421
97101	451	97378	468	97657	421
97126	350	97378	469	97659	423
97140	465	97379	469	97660	425
97140	470	97381	468	97661	425
97141	465	97382	452	97662	425
97141	470	97383	468	97664	428
97142	465	97388	452	97665	428
97142	470	97389	402	97666	434
97151	408	97390	402	97667	431
97153	408	97391	402	97668	412
97158	409	97392	452	97669	412
97159	409	97432	345	97670	432
97160	408	97437	362	97671	432
97161	408	97602	432	97673	424
97201	308	97603	432	97674	422
97224	344	97606	429	97675	422
97231	308	97609	431	97676	422
97232	308	97610	431	97678	420
97233	308	97611	418	97680	425
97235	306	97612	418	97686	428
97251	306	97614	429	97687	429
97253	306	97615	429	97688	429

Truck-Lite Part No. Page No.

97693	414
97694	414
97695	433
97701	349
97706	345
97718	434
97719	435
97720	436
97721	436
97722	436
97724	292
97725	433
97726	433
97731	435
97732	436
97733	436
97748	435
97750	423
97794	423
97799	452
97801	469
97801	470
97803	430
97804	430
97805	425
97806	416
97807	420
97808	416
97809	416
97812	413
97814	430
97815	428
97816	428
97817	428
97818	417
97819	428
97820	428
97822	416
97823	437
97827	417

Truck-Lite Part No. Page No.

97828	434
97829	434
97831	429
97835	431
97836	415
97837	417
97840	418
97843	433
97845	437
97846	412
97847	424
97848	432
97849	437
97851	452
97852	425
97860	413
97861	415
97862	430
97863	430
97865	432
97866	417
97869	435
97876	435
97905	349
97912	401
97913	403
97921	349
97921	349
97925	349
97929	401
97933	349
97940	450
97943	450
97944	450
97945	349
97946	450
97947	349
97948	450
97955	399
97956	399

Truck-Lite Part No. Page No.

97960	452
97980	316
97987	345
97989	317
98013	450
98100	443
98101	443
98102	443
98104	443
98105	443
98107	443
98108	443
98111	443
98113	443
98126	443
98127	443
98136	443
98137	443
98138	443
98144	443
98146	443
98153	443
98155	443
98165	444
98167	444
98168	445
98170	445
98180	444
99152	293
99172	292
552552	309
07080	74
07081	33
07082C	187
07092	33
07093	33
07094	58
07096C	187
07097	58
07098	33

Truck-Lite Part No.	Page No.	Truck-Lite Part No.	Page No.	Truck-Lite Part No.	Page No.
10004R	115	10205Y	114	1058A	112
10004Y	115	10208R	114	1070A	113
1001A	152	10208Y	114	10744R	159
10028R	114	10209C	273	10745R	159
10028Y	114	10212Y	114	1075A	152
10050R	108	10213Y	114	1076A	152
10050Y	108	10250R	108	1101A	123
10051R	110	10251R	110	1102A	123
10051Y	110	10251Y	110	1105A	123
10075R	109	10256R	108	1116A	115
10075Y	109	10256Y	108	1150A	149
10076R	109	10275R	109	1155A	150
10076Y	109	10275Y	109	12001R	132
10079R	110	10276R	152	12001Y	132
10079Y	110	10276Y	152	12003R	132
10085R	108	10279R	110	12003Y	132
10085Y	108	10279Y	110	1203A	135
10086R	109	10286R	109	1211A	136
10086Y	109	10286Y	109	1211W	279
10089R	111	10288R	111	1213A	136
10089Y	111	10288Y	111	1216A	161
10090R	110	10289R	111	12200C	278
10090Y	110	10289Y	111	12200R	131
10091R	111	10375R	108	12200Y	131
10091Y	111	10375Y	108	12201R	131
10092R	111	10379R	110	12201Y	131
10092Y	111	10379Y	110	1222A	136
10202B	113	10385R	109	12275R	130
10202C	273	10385Y	109	12275Y	130
10202G	113	10389R	111	1233A	145
10202R	113	10389Y	111	1259A	147
10202Y	113	10519R	113	1259B	147
10203B	153	10519Y	113	1259G	147
10203G	153	1051A	112	1264A	147
10203R	153	10520R	115	13001C	134
10203Y	153	10520Y	115	13001G	134
10204C	273	10525R	114	13001R	134
10204R	113	10525Y	114	13001Y	134
10204Y	113	1052A	112	13011C	134
10205R	114	1053A	113	13011R	134

Truck-Lite Part No. Page No.

13011Y	134
1312A	148
1313A	148
1319A	115
13200C	134
13200R	134
13200Y	134
1320A	148
13210C	134
13210R	134
13210Y	134
1350A	135
14200R	132
14200Y	132
15006R	121
15006Y	121
15008R	121
15008Y	121
15033R	119
15033Y	119
15050R	158
15050Y	158
1506A	123
1506A3	123
1506W	278
1507A	123
1508R	160
15200C	277
15200R	122
15200R3	122
15200Y	122
15200Y3	122
15201R	122
15201Y	122
15203Y	122
1520AHT	148
1520HT	148
15250R	118
15250R3	118
15250Y	118

Truck-Lite Part No. Page No.

15250Y3	118
15506R	121
15506Y	121
15507R	121
15507Y	121
1555A	146
1560A	121
1560A3	121
1561A	121
1561A3	121
1570A	132
1571A	135
15741R	159
15745R	159
15745Y	159
1590A	116
18011C	137
18011R	137
18011Y	137
18050R	137
18050Y	137
18060R	137
18060Y	137
18070R	137
18070Y	137
18085R	137
18085Y	137
18088R	137
18088Y	137
18090R	137
18090Y	137
18300R	139
18300Y	139
19002R	129
19002Y	129
19006R	124
19006Y	124
19009R	129
19009Y	129
19016R	129

Truck-Lite Part No. Page No.

19016Y	129
19031R	124
19032R	124
19036R	125
19036Y	125
19037R	125
19037Y	125
19200C	278
19200R	129
19200Y	129
19205Y	129
19250R	124
19250R3	124
19250Y	124
19250Y3	124
19251R	124
19251Y	124
19275R	125
19275Y	125
192D	312
19350R	124
19350Y	124
19375R	125
19375Y	125
1960A	128
1961A	128
20301Y	54
20304Y	54
20309Y	54
20310Y	54
20316Y	54
21001R	144
21001Y	144
21002R	145
21002Y	145
21005R	144
21005Y	144
21051R	141
21051Y	141
21056R	141

Truck-Lite Part No.	Page No.	Truck-Lite Part No.	Page No.	Truck-Lite Part No.	Page No.
21056Y	141	22004Y	55	26390Y	107
21075R	141	22006R	55	26391C	272
21075Y	141	22006Y	55	26392C	272
21080R	141	22016Y	55	26393C	272
21080Y	141	22202R	55	26394C	272
21090Y	140	22202Y	55	2660A	133
21091Y	140	25062Y	149	2661A	133
21092Y	140	25250R	138	2671A	131
21093Y	140	25250Y	138	2672A	128
21094Y	140	25750Y	138	2673A	128
21095Y	140	25760Y	150	2674A	133
21096Y	140	25761Y	150	2675A	130
21200R	144	25762Y	149	26760Y	150
21200Y	144	25765Y	138	26762Y	153
21201R	143	25766R	138	26765R	149
21201Y	143	25766Y	138	26765Y	149
21205R	144	25780R	150	26771R	149
21205Y	144	25784R	138	26771Y	149
21210Y	144	25784Y	138	27009-1	225
21251R	141	26250R	139	27012-1	224
21251Y	141	26250Y	139	2701A	76
21256R	141	26251R	139	2702A	77
21256Y	141	26251Y	139	270Y1014	307
21271R	40	26270R	139	27270C	220
21275R	142	26270Y	139	27275C	220
21275Y	142	26302B	134	27290C	223
21501R	145	26310R	146	27291C	223
21501Y	145	26310Y	146	27450C	221
21506R	144	26311R	140	27455C	221
21506Y	144	26311Y	140	27490C	223
21507R	145	26312R	146	27491C	223
21507Y	145	26312Y	146	2751A	76
2150A	142	26313R	140	27640C	222
2152A	142	26313Y	140	27645C	222
217-58	302	26315R	140	29002R	143
21880R	141	26315Y	140	29002Y	143
21880Y	141	26353R	140	29003R	143
22002R	55	26353Y	140	29003Y	143
22002Y	55	26354R	149	29202R	143
22004R	55	26354Y	149	29202Y	143

Truck-Lite Part No. Page No.

29203R	143
29203Y	143
30050R	100
30050Y	100
30051R	104
30051Y	104
30055R	100
30055Y	100
30060R	104
30060Y	104
30061R	102
30061Y	102
30065Y	104
30070R	100
30070Y	100
30071R	104
30071Y	104
30075R	101
30075Y	101
30080R	102
30080Y	102
30085R	101
30085Y	101
30086R	100
30086Y	100
30090R	102
30090Y	102
30200B	106
30200C	272
30200G	106
30200R	106
30200Y	106
30201R	151
30201Y	151
30204R	106
30204Y	106
30206C	272
30206G	106
30206R	106
30206Y	106

Truck-Lite Part No. Page No.

30221R	107
30221Y	107
30222R	106
30222Y	106
30230Y	106
30250R	100
30250Y	100
30251R	102
30251Y	102
30255R	100
30255Y	100
30257Y	106
30262R	102
30262Y	102
30264Y	101
30269Y	103
30270R	100
30270Y	100
30271Y	102
30272R	104
30272Y	104
30273R	100
30273Y	100
30275R	101
30275Y	101
30276R	151
30276Y	151
30279R	103
30279Y	103
30285R	101
30285Y	101
30286R	244
30286Y	244
30288R	103
30288Y	103
30289R	103
30289Y	103
30375R	101
30375Y	101
30379R	102

Truck-Lite Part No. Page No.

30379Y	102
30385R	100
30385Y	100
30503R	106
30503Y	106
30504R	107
30504Y	107
3050A	105
3051A	105
3053A	105
3058A	105
3070A	105
30740R	160
30742R	160
3075A	151
3076A	151
307AL	260
313AL	262
328D	459
329D	459
32A	442
33050R	116
33050Y	116
33051R	117
33051Y	117
33060B	270
33060G	270
33060PR	268
33060R	270
33060Y	270
33061B	271
33061C	271
33061G	271
33061PR	271
33061R	271
33061Y	271
33062B	271
33062C	271
33062G	271
33062PR	269

Truck-Lite Part No.	Page No.	Truck-Lite Part No.	Page No.	Truck-Lite Part No.	Page No.
33062R	271	33260B	270	35201Y	126
33062Y	271	33260C	270	35207Y	127
33065B	268	33260G	270	35209Y	127
33065C	268	33260PR	270	35375R	126
33065G	268	33260R	270	35375R3	126
33065PR	268	33260Y	270	35375Y	126
33065R	268	33265B	268	35375Y3	126
33065Y	268	33265C	268	3550A	128
33066B	269	33265G	268	35740R	158
33066C	269	33265PR	268	35740Y	158
33066G	269	33265R	268	35741R	158
33066PR	269	33265Y	268	35741Y	158
33066R	269	33275R	116	35880R	126
33066Y	269	33275Y	116	35880Y	126
33067B	269	33285R	116	35890R	127
33067C	269	33285Y	116	35890Y	127
33067G	269	333A	263	36100R	120
33067PR	269	33740R	156	36100Y	120
33067R	269	33751R	156	36105R	119
33067Y	269	35001R	126	36105Y	119
33075R	116	35001R3	126	36110R	120
33075Y	116	35001Y	126	36110Y	120
33080R	117	35001Y3	126	36115R	119
33080Y	117	35004R	127	36115Y	119
33203R	117	35004Y	127	36130R	120
33203Y	117	35007Y	127	36130Y	120
33204R	117	35009Y	127	3613W	186
33204Y	117	35033R	156	36203R	120
33205R	117	35034R	157	36203Y	120
33205Y	117	35035R	156	36213R	120
33206R	117	35036R	157	3691W	186
33206Y	117	35075R	126	3693W	186
33207R	118	35075Y	126	37270C	219
33207Y	118	35080R	126	37450C	219
33208R	118	35080Y	126	3753A	77
33208Y	118	35200R	126	3755A	77
33209Y	117	35200R3	126	37640C	219
33250R	116	35200Y	126	37645C	219
33250Y	116	35200Y3	126	3805Y115	81
33256Y	116	35201R	126	3850AA	80

Truck-Lite Part No. Page No.

3853AA	81
40001Y	52
40002R	20
40002Y	68
40006R	20
40009R	20
40009Y	68
40015R	21
40028R	21
40028Y	69
40029R	22
40041Y	52
40042R	19
40048R	19
40058R	19
40201Y	52
40202R	20
40202Y	68
40206C	184
40206R	20
40206Y	68
40209R	20
40209Y	68
40215R	21
40222R	21
40229R	22
40232R	21
40233R	21
40233Y	68
4023Y106	43
40241R	52
40241Y	52
40242R	19
40242Y	69
40247R	38
40248R	19
4024Y106	43
40258R	19
40258Y	69
40259R	19

Truck-Lite Part No. Page No.

40270C	288
40271C	288
4027D	42
40282R	21
40282Y	69
40285R	22
40302R	20
40302Y	68
4050A	66
4053A	66
4058A	66
4060C	182
4063C	183
4091A	64
4093A	64
4094A	64
4094SW	280
4095A	58
4095A	64
41005R	32
41006R	32
41007R	32
41008R	32
41202R	32
41203R	32
41A	441
433WD	280
434WD	278
43A	441
44001Y	51
44003Y	67
44018Y	51
44021Y	51
44022R	17
44023Y	67
44024Y	67
44026R	17
44027Y	51
44030R	12
44032R	14

Truck-Lite Part No. Page No.

44034R	14
44036R	14
44038R	14
44040C	182
44041C	181
44042C	274
44044C	182
44045C	181
44057C	273
44071Y	67
44082R	16
44083R	17
44091Y	65
44092R	12
44092Y	65
44093Y	65
44094Y	65
44095Y	65
44101R	246
44101Y	246
44102R	246
44102Y	246
44103R	246
44103Y	246
44104R	246
44104Y	246
44107Y	50
44108Y	50
44109Y	50
44110Y	245
44113Y	50
44114Y	245
44121R	17
44141C	181
44145C	181
44146C	181
44180C	179
44181C	180
44182C	180
44183C	179

Truck-Lite Part No.	Page No.	Truck-Lite Part No.	Page No.	Truck-Lite Part No.	Page No.
44184C	179	44283Y	50	44551R	35
44201Y	51	44284Y	50	44552R	35
44202R	16	44285Y	50	44553R	35
44203Y	67	44286Y	50	44554R	35
44205C	182	44287Y	50	44555R	34
44206C	181	44289Y	50	44556R	34
44207C	274	44290Y	50	44557R	34
44211Y	246	44291Y	65	44602R	14
44211Y	246	44292Y	65	44605R	34
44212R	246	44293Y	65	44610R	35
44212Y	246	44294Y	65	44622R	15
44213R	246	44295Y	65	44625R	35
44213Y	246	44302R	12	44871Y	67
44214R	246	44304C	203	44877Y	67
44214Y	246	44308C	273	44878Y	67
44216R	247	44322R	14	44881Y	51
44216Y	247	44326R	14	44882R	16
44217Y	245	44328R	14	44883R	17
44218Y	245	44332R	12	44887Y	51
44221Y	51	44334R	14	44888Y	51
44222R	17	44339C	274	44932R	17
44223Y	67	44344C	180	44934R	226
44224Y	67	44345C	180	44936R	17
44226R	17	44346C	180	44954R	15
44227Y	51	44347C	179	44959R	12
44231Y	51	44348C	180	44960R	12
44233Y	67	44349C	180	44982R	12
44235C	182	44350C	179	44983R	14
44236C	181	44350R	12	44986R	14
44237C	275	44351R	12	44988R	14
44239C	181	44352C	274	44990C	179
44240C	181	44353R	12	44991C	180
44248Y	245	44355R	12	44992C	180
44249Y	245	44356R	15	45001R	58
44253R	16	44362R	15	45001Y	58
44266R	16	44363R	15	45002R	33
44273Y	51	44365R	15	45002Y	74
44276Y	51	44438C	274	45007R	40
44280Y	50	44439C	274	4501A	66
44281Y	50	44550R	35	45021Y	57

Truck-Lite Part No. Page No.

45022R	75
45032R	75
45041R	227
45042R	31
45058R	31
45201R	58
45201Y	58
45202R	33
45202Y	74
45207R	40
45256Y	57
45258R	31
45259R	32
45278R	31
45279R	32
4550A	55
4558A	55
4560C	187
45931R	227
45932R	31
45A	440
47A	440
47ADB	440
47DB	440
4805AAY118	87
4805AY116	87
4805AY117	87
485AAY115	87
4872AA	84
4874AY101	87
49002R	20
49003C	186
49202R	20
49203C	186
5013K	43
5014K	43
5014Y101	45
5014Y102	44
5015K	41
5016K	41

Truck-Lite Part No. Page No.

5019200R3	129
5019200Y3	129
5023Y102	44
50373N	444
52A	440
5315Y101	44
5316Y101	44
549SWD	279
54A	441
57A	441
5800AA	87
5800AAK	87
60001R	63
60001Y	63
60002R	30
60002Y	73
60004C	190
60007R	30
60007Y	63
60013R	39
60015R	63
60015Y	63
60021R	75
60022Y	72
60023R	75
60024Y	75
60050R	28
60050R	28
60052R	28
60056R	28
60061R	38
60062R	38
60072Y	62
60075Y	61
60080Y	60
60082Y	61
60083R	30
60085R	28
60085R	28
60092C	190

Truck-Lite Part No. Page No.

60094Y	72
60096Y	72
60097Y	72
60120R	250
60120Y	250
60122R	250
60122Y	250
60124R	250
60124Y	250
60126R	250
60126Y	250
60180R	62
60180Y	62
60201R	64
60201Y	64
60202R	30
60202Y	73
60204C	190
60207R	30
60207Y	73
60213R	39
60215R	63
60215Y	63
60217Y	63
60250R	28
60250R	28
60252R	28
60253R	28
60253R	28
60255Y	61
60256R	28
60260R	38
60262R	38
60264R	28
60266R	38
60272Y	62
60275Y	61
60276Y	62
60280Y	60
60282Y	61

Truck-Lite Part No.	Page No.	Truck-Lite Part No.	Page No.	Truck-Lite Part No.	Page No.
60283R	30	60557R	36	66250R	25
60283Y	74	60559R	36	66252R	25
60284C	190	6058A	71	66254R	25
60286Y	61	60602R	27	6660PS	303
60290Y	72	6060C	189	66882R	25
60291Y	72	60610R	36	66885R	25
60292Y	72	60622R	27	6810AL	259
60302R	29	60630R	37	6810MAL	259
60302Y	73	60872Y	62	6811AL	257
60303R	39	60885R	28	6811MA	257
60340R	29	60885R	28	6823A	263
60340Y	73	60891Y	61	69002Y	64
60344Y	63	60892Y	72	69003C	190
60345C	190	610W	211	69202Y	64
60354C	203	613W	229	70310R	78
60360R	250	620H	316	70330R	77
60360Y	250	620W	208	70330Y	77
60362R	250	627WD	211	7044DB	426
60362Y	250	628WD	211	775863C93	462
60364R	250	629WD	211	7973D	419
60364Y	250	630H	317	801251C	281
60366R	250	630w4	208	80162C	279
60366Y	250	630W4	208	80164C	279
60420Y	60	6500A	54	80250C	282
60421Y	59	6501A	54	80255C	282
60422Y	59	6503A	53	80302R	22
60423Y	60	6600A	261	80302Y	70
60424R	60	6600B	261	80334R	22
60424Y	60	6600MA	262	80335R	22
60425Y	60	6600W	261	80336R	22
6050A	71	6601A	258	80339R	22
6051A	71	6601MA	258	80423C	276
6053A	71	66050R	25	80461R	23
60550R	37	66052R	25	80462R	23
60551R	37	66054R	25	80463R	23
60552R	37	66056R	25	8101D	197
60553R	37	66082R	25	8102D	197
60554R	37	66085R	25	8103D	197
60555R	37	66205C	188	8104D	197
60556R	36	66206C	188	8105D	197

Truck-Lite Part No. Page No.

8107D	197
8108D	197
8109D	197
81300R	53
81300Y	53
81301R	53
81301Y	53
81335C	201
8370B	252
8370R	252
8370W	252
84200C	281
88-02210	346
88-2126	299
88-43210	300
88-88130	346
8861A	294
8900A	291
8918A	290
8919A	287
8923A	292
8925A	292
8930A	291
8933A	289
8935W	287
8936A	286
8936B	286
8937A	289
8938A	294
8939A	291
8943A	286
8943W	286
8945A	286
8946A	289
8946W	289
8947A	291
8951W	317
8952W	317
8960A	294
8977A	289

Truck-Lite Part No. Page No.

9001Y	286
9004A	294
9004G	294
9004W	294
9005A	290
9005W	290
9006A	289
9007A	289
9007B	289
9007W	289
900Y166	461
900Y170	461
900Y179	461
900Y180	461
900Y209	461
900Y73	461
9016A	287
9016B	287
9016W	287
9021A	287
9021W	287
90251Y103	460
90251Y1033	460
9029A	286
9029B	286
90325Y	53
90327R	24
90327Y	70
9041A	286
9057A	291
9059A	290
9059W	290
9061A	289
9063A	294
9074A	294
9076W	286
9077A	289
9077W	289
9078A	294
9079A	294

Truck-Lite Part No. Page No.

9080A	291
9081A	286
9082A	290
9083A	294
9084A	294
9087A	289
9093A	289
9093B	289
9093W	289
91002R	24
91002Y	70
91202R	24
91202Y	70
91205Y	70
91241Y	54
91242R	24
91243Y	54
91244R	23
91315R	24
91315Y	70
91369R	23
915Y103	461
915Y104	463
915Y105	463
915Y114	463
915Y116	463
915Y117	463
915Y119	460
915Y124	463
915Y128	460
92513Y	254
92516C	255
92516Y	255
92523Y	264
92525B	265
92525Y	265
92534YL	261
92539Y	262
92560L	261
92564C	259

Truck-Lite Part No.	Page No.	Truck-Lite Part No.	Page No.	Truck-Lite Part No.	Page No.
92564Y	259	9373W	292	99005R	286
92565B	256	9382A	294	99005Y	286
92565C	256	9382W	294	99007C	286
92565R	256	9384A	294	99007R	286
92565Y	256	9410BL	400	99007Y	286
92566Y	256	9414BL	400	99008C	287
92568C	256	9415BL	400	99008R	287
92568R	256	956AA	84	99008Y	287
92568Y	256	957AA	84	99009R	286
92569Y	257	960Y101	460	99009Y	286
92590Y	264	96259-3	451	99010C	287
92677Y	265	96260-3	451	99010R	287
92860Y	256	962Y102	460	99010Y	287
92861Y	258	97101-3	451	99012R	291
92862Y	260	9719A	286	99012Y	291
92863Y	260	9720A	287	99021R	288
92864Y	255	9720B	287	99021Y	288
92865Y	254	9720W	287	99027Y	289
92866Y	264	9723A	288	99034R	286
92868Y	265	97944-1	450	99034Y	286
92871B	251	97944-3	450	99035R	286
92871C	251	97946-3	450	99035Y	286
92871R	251	97960-3	452	99041R	289
92871Y	251	98003R	442	99041Y	289
92872B	247	98003Y	442	99043R	289
92872C	247	98031R	441	99043Y	289
92872R	247	98031Y	441	99044R	286
92872Y	247	98033R	443	99044Y	286
92873R	251	98033Y	443	99050R	289
92873Y	251	98034R	443	99050Y	289
92875R	251	98034Y	443	99051R	289
92875Y	251	98035R	442	99051Y	289
92WD	186	98035Y	442	99063R	294
9341A	286	98154R	443	99063Y	294
9341B	286	98176R	442	99066Y	287
9341G	286	98176RB	442	99067R	289
9341W	286	98176Y	442	99067Y	289
9342A	290	98176YB	442	99077R	289
9371A	291	99001R	286	99077Y	289
9372A	292	99005C	286	99080C	287

Truck-Lite Part No. Page No.

99082C	287
99082R	287
99083R	287
99086R	292
99086Y	292
99087R	292
99087Y	292
99088C	288
99088R	288
99090R	286
99090Y	286
99101R	287
99104R	286
99105R	286
99107Y	286
99108Y	288
99120B	286
99120C	286
99120R	286
99126R	292
99127R	292
99143C	288
99143Y	288
99145Y	288
99147Y	286
99150C	287
99151Y	293
99158Y	290
99160C	290
99160R	291
99160Y	291
99165Y	294
99167Y	288
99168C	288
99168R	288
99168Y	288
99169R	288
99169Y	288
99170R	291
99170Y	291

Truck-Lite Part No. Page No.

99176C	287
99184C	290
99184R	290
99184Y	290
99193Y	293
99203Y	293
99220B	288
99220R	288
99220W	288
99220Y	288
99221R	288
99221W	288
99221Y	288
99233C	291
99234C	291
99235C	292
99236C	292
99238R	291
99238Y	291
99245C	293
99250B	288
99250C	288
99250Y	288
99252C	288
99252Y	288
L48SM	470
P340	470
P440	470

SEE & BE SEEN®

Four Truck-Lite projector beam LED headlights are shown in a stack. The top one is circular, and the others are rectangular. They are arranged in a way that shows their internal LED components and lens structures. The text "DESIGNED TO OUTSHINE." is overlaid in large, white, bold letters across the center of the headlights.

DESIGNED TO OUTSHINE.

New Projector Beam LED Headlights

Corporate

corporate@truck-lite.com
(800) 888-7095

Customer Service

customerservice@truck-lite.com
(800) 562-5012

Technical Support

tltech@truck-lite.com
(888) 562-5012



truck-lite.com

SEE & BE SEEN[®]



DESIGNED & PRINTED
IN THE USA